



**THE DATASHEET OF
ECS-.327-12.5-1210-TR**



The ultra-miniature 2-Pad ECX-1210 is a very compact SMD Tuning Fork Crystal. The 1.2 x 1.0 x 0.5 mm **smallest** in it's class ceramic package is ideal for LoRa Wan, wearable devices, IoT, and medical applications.

[Request a Sample](#)

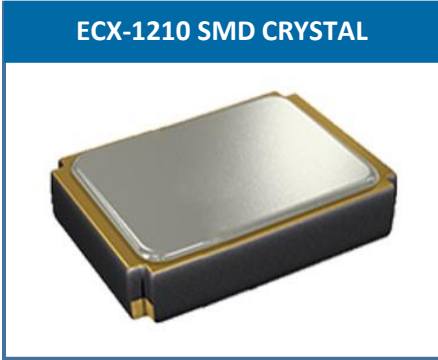

- Low Power RTC Applications such as STM32 [AN2867](#)
- 1.2 x 1.0 mm Footprint
- Extended Temp. Range
- RoHS Compliant
- Applications: Automotive, COTS, Industrial, IOT

OPERATING CONDITIONS / ELECTRICAL CHARACTERISTICS

PARAMETERS	CONDITIONS	ECX-1210			UNITS
		MIN	TYP	MAX	
Frequency			32.768		KHz
Frequency Tolerance	@ +25°C			± 20 *	ppm
Load Capacitance	Specify in P/N		12.5		pF
Drive Level	DL		0.1	0.5	μW
Equivalent Series Resistance	R1			90K	Ω
Turnover Temperature		+20	+25	+30	°C
Temperature Coefficient		-0.02	-0.03	-0.040	ppm/°C ²
Shunt Capacitance	Co		1.1		pF
Aging (First Year)	@ +25°C ±3°C			±3	ppm
Operating Temperature	T _{opr}	-40		+85	°C
Storage Temperature	T _{stg}	-40		+85	°C

DIMENSIONS (mm)

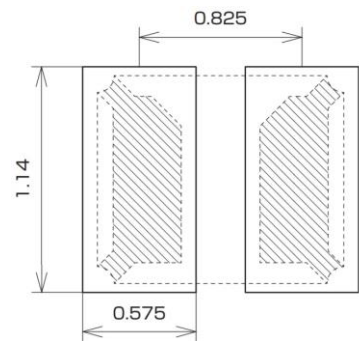
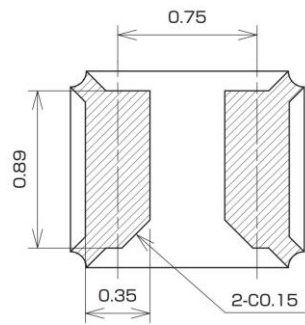
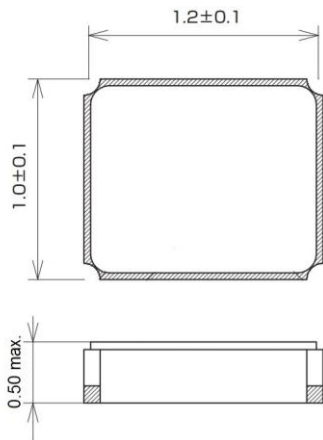

Figure 2) Suggested Land Pattern

PAD CONNECTIONS

1	In/Out
2	Out/In

Figure 1) Top, Side, and Bottom views

PART NUMBERING GUIDE: Example ECS-.327-12.5-1210-TR

ECS - FREQUENCY ABBREVIATION	LOAD CAPACITANCE	PACKAGE	CUSTOM OPTIONS Tolerance	PACKAGING
ECS	.327 = 32.768 KHz	-1210 = ECX-1210	Blank = ±20 ppm * C = ± 10 ppm	TR = Tape & Reel 5K/Reel
	12.5 = 12.5 pF 9 = 9 pF 7 = 7 pF 6 = 6 pF			

*Contact ECS for availability

Rev.2021

POCKET TAPE DIMENSIONS (mm)

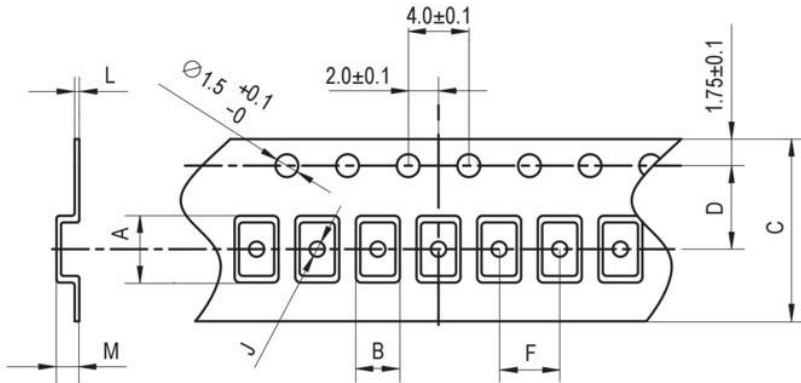

A	B	C	D	F	J	L	M	Reel Dia.	Qty/Reel
1.42	1.17	8.0	3.5	4.0	0.5	0.2	0.65	180	5000pcs

SOLDER PROFILE
Peak solder Temp +260°C Max 10 sec Max.
2 Cycles Max.
MSL 1, Lead Finish Au

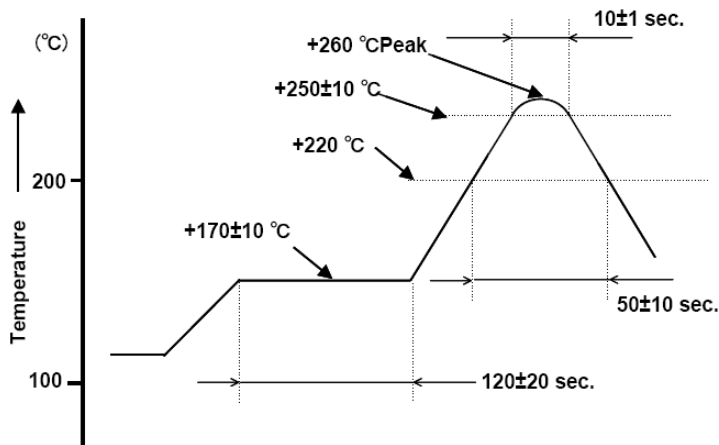



Figure 1) Suggested Reflow Profile

Looking for pricing, stock, or lifecycle information?

Click below to explore more details on WIN SOURCE:

-  [View ECS-.327-12.5-1210-TR on WIN SOURCE](#)
-  [ECS Inc. Information](#)

Optimize Your Supply Chain with WIN SOURCE Solutions

-  Global Sourcing Solution
-  Obsolete Management
-  Cost Control Management
-  Shortage Management
-  Alternative Solution
-  Excess Inventory Management