



# THE DATASHEET OF PWB80A30



# THYRISTOR MODULE (NON-ISOLATED TYPE)

## PWB80A

PWB80A is a Thyristor module suitable for low voltage, 3 phase recifier applications.

- $I_{T(AV)}$  80A (each device)
- High Surge Current 2500 A (60Hz)
- Easy Construction
- Non-isolated. Mounting base as common Anode terminal

### (Applications)

Welding power Supply  
Various DC power Supply

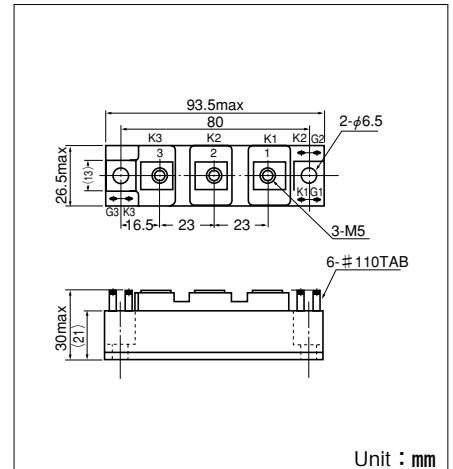
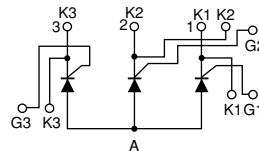

### Maximum Ratings

Symbol	Item	Ratings		Unit
		PWB80A30	PWB80A40	
VRRM	Repetitive Peak Reverse Voltage	300	400	V
VRSM	Non-Repetitive Peak Reverse Voltage	360	480	V
VDRM	Repetitive Peak Off-State Voltage	300	400	V

Symbol	Item	Conditions	Ratings	Unit	
$I_{T(AV)}$	Average On-State Current	Single phase, half wave, 180° conduction, $T_c : 116^\circ\text{C}$	80	A	
$I_{T(RMS)}$	R.M.S. On-State Current	Single phase, half wave, 180° conduction, $T_c : 116^\circ\text{C}$	125	A	
$I_{TSM}$	Surge On-State Current	$\frac{1}{2}$ cycle, 50Hz/60Hz, peak value, non-repetitive	2280/2500	A	
$I^2t$	$I^2t$		26000	A <sup>2</sup> S	
P <sub>GM</sub>	Peak Gate Power Dissipation		10	W	
P <sub>G(AV)</sub>	Average Gate Power Dissipation		1	W	
I <sub>FGM</sub>	Peak Gate Current		3	A	
V <sub>FGM</sub>	Peak Gate Voltage(Forward)		10	V	
V <sub>RGM</sub>	Peak Gate Voltage(Reverse)		5	V	
di/dt	Critical Rate of Rise of On-State Current	$I_G=200\text{mA}$ , $T_j=25^\circ\text{C}$ , $V_D=\frac{1}{2}V_{DRM}$ , $dI_G/dt=1\text{A}/\mu\text{s}$	50	A/ $\mu\text{s}$	
T <sub>j</sub>	Operating Junction Temperature		-30 to +150	°C	
T <sub>stg</sub>	Storage Temperature		-30 to +125	°C	
	Mounting torque	Mounting (M6)	Recommended Value 2.5-3.9 (25-40)	4.7 (48)	N·m (kgf·cm)
		Terminal (M5)	Recommended Value 1.5-2.5 (15-25)	2.7 (28)	
	Mass			170	g

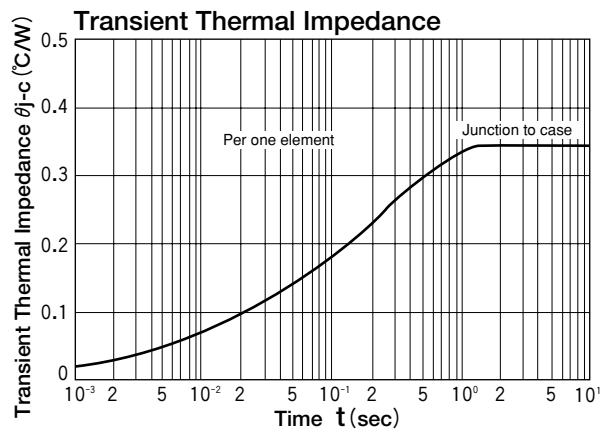
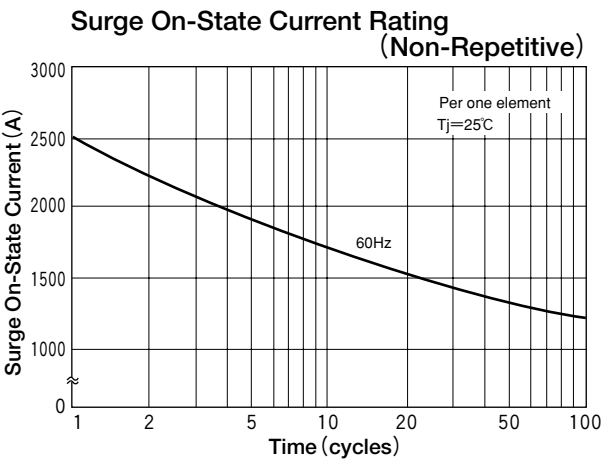
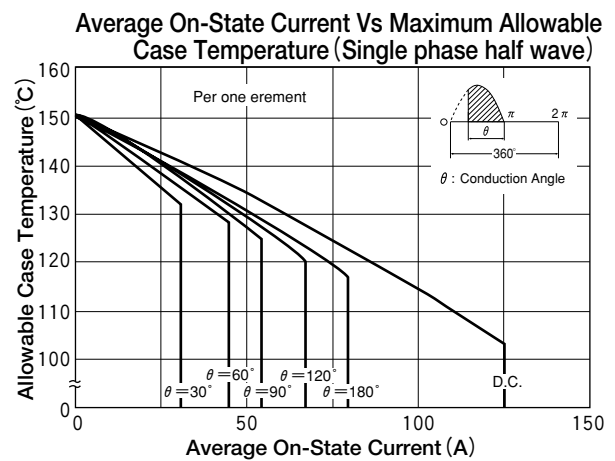
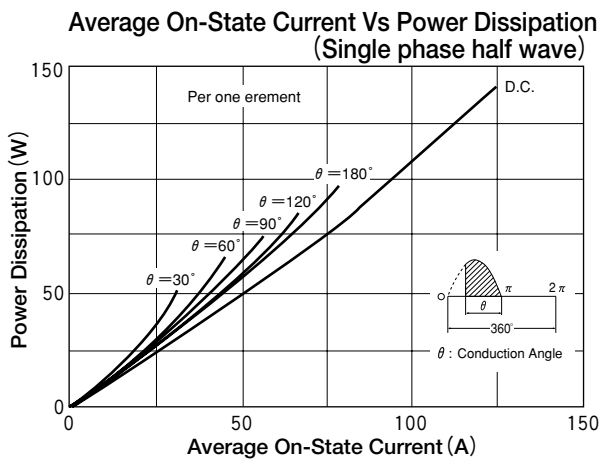
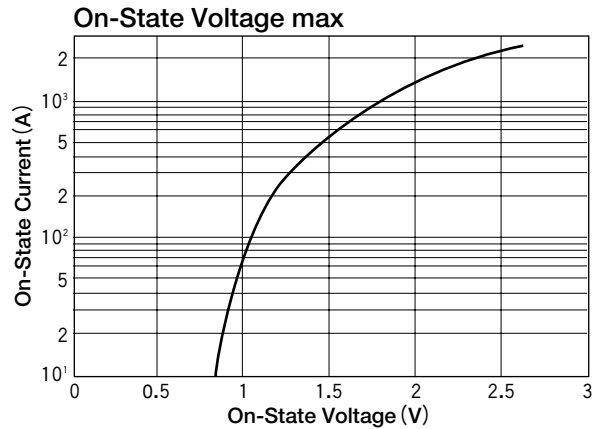
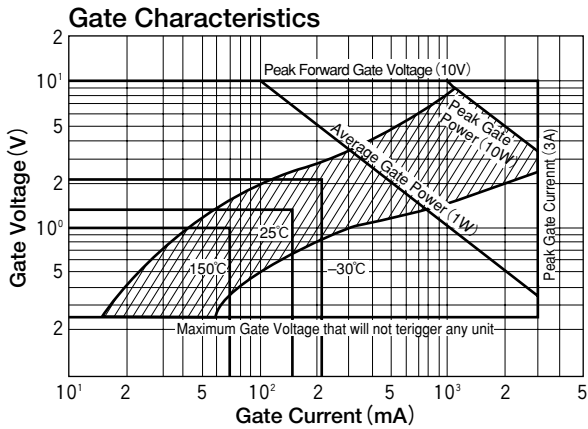

### Electrical Characteristics

Symbol	Item	Conditions	Ratings	Unit
I <sub>DRM</sub>	Repetitive Peak Off-State Current, max.	at $V_{DRM}$ , single phase, half wave, $T_j=150^\circ\text{C}$	12	mA
I <sub>RRM</sub>	Repetitive Peak Reverse Current, max.	at $V_{DRM}$ , single phase, half wave, $T_j=150^\circ\text{C}$	12	mA
V <sub>TM</sub>	Peak On-State Voltage, max	On-State Current 240A, $T_j=25^\circ\text{C}$ Inst. measurement	1.20	V
$I_{GT}/V_{GT}$	Gate Trigger Current/Voltage, max.	$T_j=25^\circ\text{C}$ , $I_T=1\text{A}$ , $V_D=6\text{V}$	150/2	mA/V
V <sub>GD</sub>	Non-Trigger Gate, Voltage. min.	$T_j=150^\circ\text{C}$ , $V_D=\frac{1}{2}V_{DRM}$	0.25	V
t <sub>gt</sub>	Turn On Time, max.	$I_T=80\text{A}$ , $I_G=200\text{mA}$ , $T_j=25^\circ\text{C}$ , $V_D=\frac{1}{2}V_{DRM}$ , $dI_G/dt=1\text{A}/\mu\text{s}$	10	$\mu\text{s}$
dv/dt	Critical Rate of Rise of Off-State Voltage, min.	$T_j=150^\circ\text{C}$ , $V_D=\frac{2}{3}V_{DRM}$ , Exponential wave.	50	V/ $\mu\text{s}$
I <sub>H</sub>	Holding Current, typ.	$T_j=25^\circ\text{C}$	100	mA
R <sub>th(j-c)</sub>	Thermal Impedance, max.	Junction to case ( $\frac{1}{3}$ Module)	0.35	°C/W



## Looking for pricing, stock, or lifecycle information?

Click below to explore more details on WIN SOURCE:

-  [View PWB80A30 on WIN SOURCE](#)
-  [SanRex Corporation Information](#)

## Optimize Your Supply Chain with WIN SOURCE Solutions

-  Global Sourcing Solution
-  Obsolete Management
-  Cost Control Management
-  Shortage Management
-  Alternative Solution
-  Excess Inventory Management