



**THE DATASHEET OF  
LTM4637IY#PBF**



# 20A DC/DC $\mu$ Module Step-Down Regulator

## FEATURES

- Complete 20A Switch Mode Power Supply
- 4.5V to 20V Input Voltage Range
- 0.6V to 5.5V Output Voltage Range
- $\pm 1.5\%$  Total DC Output Voltage Error ( $-40^{\circ}\text{C}$  to  $125^{\circ}\text{C}$ )
- Differential Remote Sense Amplifier for Precision Regulation for ( $V_{\text{OUT}} \leq 3.3\text{V}$ )
- Current Mode Control/Fast Transient Response
- Parallel Current Sharing (Up to 80A)
- Frequency Synchronization
- Selectable Pulse-Skipping or Burst Mode<sup>®</sup> Operation
- Soft-Start/Voltage Tracking
- Up to 88% Efficiency ( $12\text{V}_{\text{IN}}$ ,  $1.8\text{V}_{\text{OUT}}$ )
- Overcurrent Foldback Protection
- Output Overvoltage Protection
- Internal Temperature Monitor
- Overtemperature Protection
- $15\text{mm} \times 15\text{mm} \times 4.32\text{mm}$  LGA and  $15\text{mm} \times 15\text{mm} \times 4.92\text{mm}$  BGA Packages
- SnPb (BGA) or RoHS Compliant (LGA and BGA) Finish

## APPLICATIONS

- Telecom Servers and Networking Equipment
- Industrial Equipment
- Medical Systems
- High Ambient Temperature Systems

## DESCRIPTION

The LTM<sup>®</sup>4637 is a complete 20A output high efficiency switch mode step-down DC/DC  $\mu$ Module (micromodule) regulator. Included in the package are the switching controller, power FETs, inductor and compensation components. Operating over an input voltage range from 4.5V to 20V, the LTM4637 supports an output voltage range of 0.6V to 5.5V, set by a single external resistor. Only a few input and output capacitors are needed.

Current mode operation allows precision current sharing of up to four LTM4637 regulators to obtain up to 80A output. High switching frequency and a current mode architecture enable a very fast transient response to line and load changes without sacrificing stability. The device supports frequency synchronization, multiphase/current sharing, Burst Mode operation and output voltage tracking for supply rail sequencing. A diode-connected PNP transistor is available for use as an internal temperature monitor.

The LTM4637 is offered in  $15\text{mm} \times 15\text{mm} \times 4.32\text{mm}$  LGA and  $15\text{mm} \times 15\text{mm} \times 4.92\text{mm}$  packages. The LTM4637 is available with SnPb (BGA) or RoHS-compliant terminal finish. The LTM4637 is pin compatible with the LTM4627, a 15A DC/DC  $\mu$ Module regulator.

All registered trademarks and trademarks are the property of their respective owners. Protected by U.S. patents, including 5481178, 5847554, 6580258, 6304066, 6476589, 6774611, 6677210, 8163643.

## TYPICAL APPLICATION

12V<sub>IN</sub>, 1.2V<sub>OUT</sub>, 20A DC/DC  $\mu$ Module<sup>®</sup> Regulator

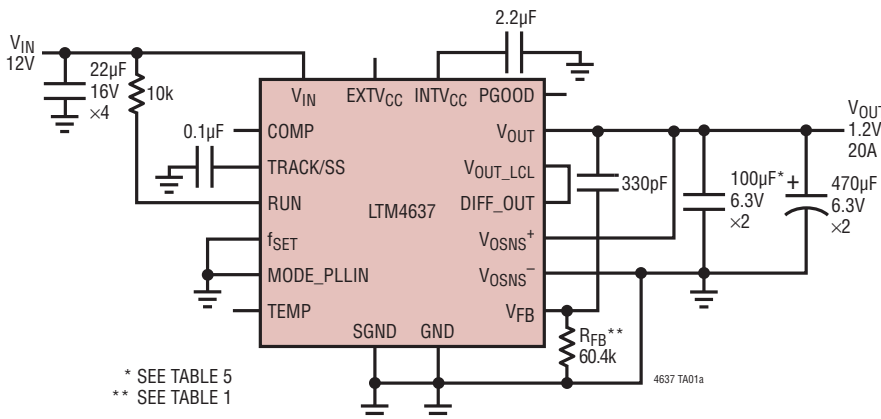

\* SEE TABLE 5  
\*\* SEE TABLE 1

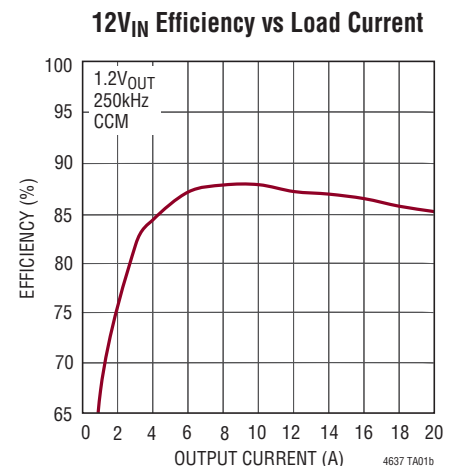

## ABSOLUTE MAXIMUM RATINGS (Note 1)

$V_{IN}$ .....	-0.3V to 22V	TEMP .....	-0.3V to 0.8V
$V_{OUT}$ .....	-0.3V to 6V	INTV <sub>CC</sub> Peak Output Current (Note 6) .....	100mA
INTV <sub>CC</sub> , $V_{OUT\_LCL}$ , PGOOD, EXT <sub>VCC</sub> .....	-0.3V to 6V	Internal Operating Temperature Range	
MODE_PLLIN, $f_{SET}$ , TRACK/SS,		(Note 2) .....	-40°C to 125°C
$V_{OSNS^-}$ , $V_{OSNS^+}$ , DIFF_OUT .....	-0.3V to INTV <sub>CC</sub>	Storage Temperature Range .....	-55°C to 125°C
$V_{FB}$ , COMP (Note 7) .....	-0.3V to 2.7V	Reflow (Peak Body) Temperature .....	245°C
RUN (Note 5) .....	-0.3V to 5V		

## PIN CONFIGURATION

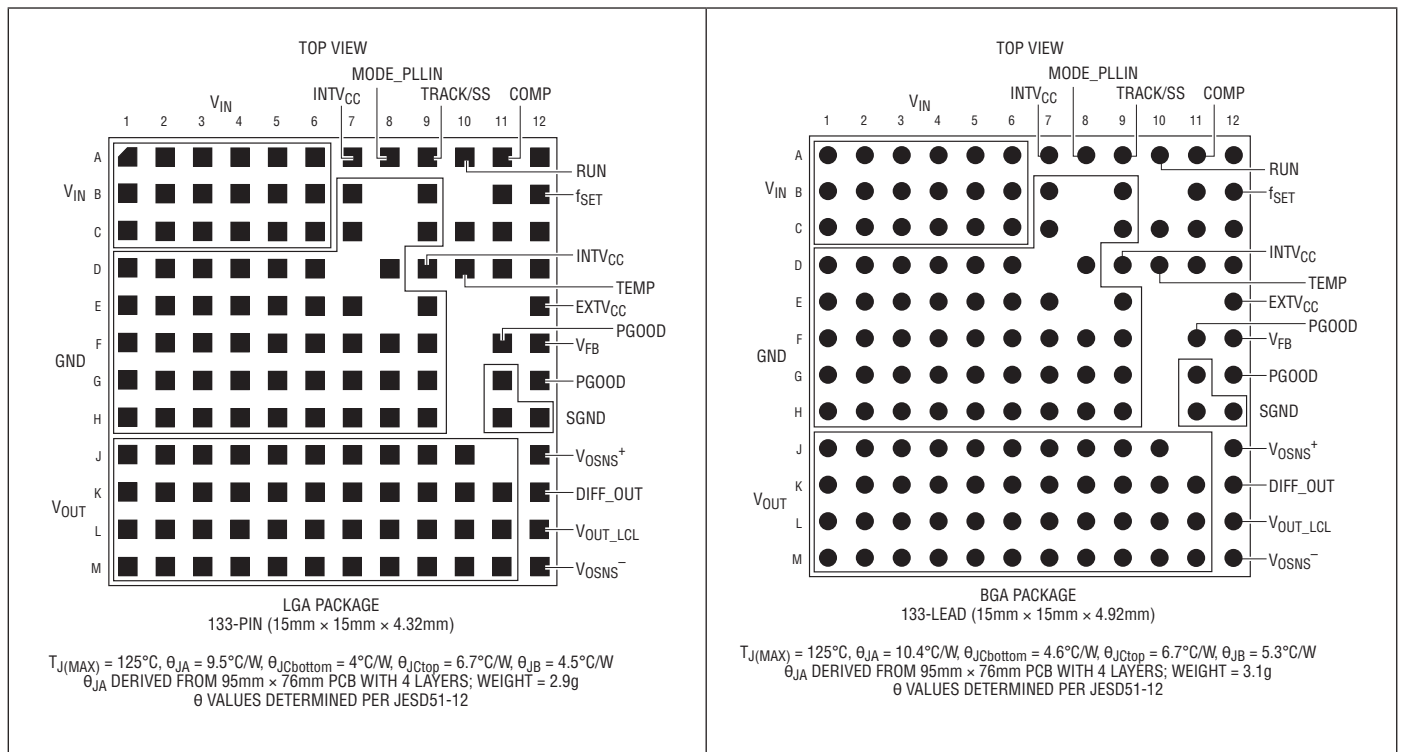

## ORDER INFORMATION

PART NUMBER	PAD OR BALL FINISH*	PART MARKING		PACKAGE TYPE	MSL RATING	TEMPERATURE RANGE (Note 2)
		DEVICE	FINISH CODE			
LTM4637EV#PBF	Au (RoHS)	LTM4637V	e4	LGA	4	-40°C to 125°C
LTM4637IV#PBF	Au (RoHS)	LTM4637V	e4	LGA	4	-40°C to 125°C
LTM4637EY#PBF	SAC305 (RoHS)	LTM4637Y	e1	BGA	4	-40°C to 125°C
LTM4637IY#PBF	SAC305 (RoHS)	LTM4637Y	e1	BGA	4	-40°C to 125°C
LTM4637IY	SnPb (63/37)	LTM4637Y	e0	BGA	4	-40°C to 125°C

- Contact the factory for parts specified with wider operating temperature ranges. \*Pad or ball finish code is per IPC/JEDEC J-STD-609.
- [Recommended LGA and BGA PCB Assembly and Manufacturing Procedures](#)
- [LGA and BGA Package and Tray Drawings](#)

## ELECTRICAL CHARACTERISTICS

The ● denotes the specifications which apply over the specified internal operating temperature range (Note 2), otherwise specifications are at  $T_A = 25^\circ\text{C}$ .  $V_{IN} = 12\text{V}$ , per the typical application in Figure 22.

SYMBOL	PARAMETER	CONDITIONS	MIN	TYP	MAX	UNITS
$V_{IN}$	Input DC Voltage	●	4.5		20	V
$V_{OUT}$ Range	$V_{OUT}$ Range	●	0.6		5.5	V
$V_{OUT(DC)}$	Output Voltage, Total Variation with Line and Load	● $C_{IN} = 22\mu\text{F} \times 3$ $C_{OUT} = 100\mu\text{F}$ Ceramic, $470\mu\text{F}$ POSCAP $R_{FB} = 40.2\text{k}$ , $\text{MODE\_PLLIN} = \text{GND}$ $V_{IN} = 5\text{V}$ to $20\text{V}$ , $I_{OUT} = 0\text{A}$ to $20\text{A}$ (Note 4)	1.477	1.50	1.523	V

### Input Specifications

$V_{RUN}$	RUN Pin On Threshold	$V_{RUN}$ Rising	1.1	1.25	1.4	V
$V_{RUNHYS}$	RUN Pin On Hysteresis			130		mV
$I_{Q(VIN)}$	Input Supply Bias Current	$V_{IN} = 12\text{V}$ , $V_{OUT} = 1.5\text{V}$ , Burst Mode Operation, $I_{OUT} = 0.1\text{A}$ $V_{IN} = 12\text{V}$ , $V_{OUT} = 1.5\text{V}$ , Pulse-Skipping Mode, $I_{OUT} = 0.1\text{A}$ $V_{IN} = 12\text{V}$ , $V_{OUT} = 1.5\text{V}$ , Switching Continuous, $I_{OUT} = 0.1\text{A}$ Shutdown, $RUN = 0$ , $V_{IN} = 12\text{V}$		17		mA
				25		mA
				54		mA
				40		$\mu\text{A}$
$I_{S(VIN)}$	Input Supply Current	$V_{IN} = 5\text{V}$ , $V_{OUT} = 1.5\text{V}$ , $I_{OUT} = 20\text{A}$ $V_{IN} = 12\text{V}$ , $V_{OUT} = 1.5\text{V}$ , $I_{OUT} = 20\text{A}$		6.8		A
				2.87		A

### Output Specifications

$I_{OUT(DC)}$	Output Continuous Current Range	$V_{IN} = 12\text{V}$ , $V_{OUT} = 1.5\text{V}$ (Note 4)	0		20	A
$\frac{\Delta V_{OUT}(\text{Line})}{V_{OUT}}$	Line Regulation Accuracy	$V_{OUT} = 1.5\text{V}$ , $V_{IN}$ from $4.5\text{V}$ to $20\text{V}$ $I_{OUT} = 0\text{A}$	●	0.02	0.06	%/V
$\frac{\Delta V_{OUT}(\text{Load})}{V_{OUT}}$	Load Regulation Accuracy	$V_{OUT} = 1.5\text{V}$ , $I_{OUT} = 0\text{A}$ to $20\text{A}$ , $V_{IN} = 12\text{V}$ (Note 4)	●	0.2	0.45	%
$V_{OUT(AC)}$	Output Ripple Voltage	$I_{OUT} = 0\text{A}$ , $C_{OUT} = 100\mu\text{F}$ Ceramic, $470\mu\text{F}$ POSCAP $V_{IN} = 12\text{V}$ , $V_{OUT} = 1.5\text{V}$		30		mV <sub>P-P</sub>
$\Delta V_{OUT(START)}$	Turn-On Overshoot	$C_{OUT} = 100\mu\text{F}$ Ceramic, $470\mu\text{F}$ POSCAP, $V_{OUT} = 1.5\text{V}$ , $I_{OUT} = 0\text{A}$ , $V_{IN} = 12\text{V}$		15		mV
$t_{START}$	Turn-On Time	$C_{OUT} = 100\mu\text{F}$ Ceramic, $470\mu\text{F}$ POSCAP, No Load, $\text{TRACK/SS} = 0.001\mu\text{F}$ , $V_{IN} = 12\text{V}$		0.6		ms
$\Delta V_{OUTLS}$	Peak Deviation for Dynamic Load	Load: 0% to 50% to 0% of Full Load $C_{OUT} = 100\mu\text{F} \times 2$ Ceramic, $470\mu\text{F} \times 3$ POSCAP, $V_{IN} = 12\text{V}$ , $V_{OUT} = 1.5\text{V}$		50		mV
$t_{SETTLE}$	Settling Time for Dynamic Load Step	Load: 0% to 50% to 0% of Full Load, $V_{IN} = 5\text{V}$ , $C_{OUT} = 100\mu\text{F} \times 2$ Ceramic, $470\mu\text{F} \times 3$ POSCAP		50		$\mu\text{s}$
$I_{OUTPK}$	Output Current Limit	$V_{IN} = 12\text{V}$ , $V_{OUT} = 1.5\text{V}$ $V_{IN} = 5\text{V}$ , $V_{OUT} = 1.5\text{V}$		30		A
				30		A

### Control Section

$V_{FB}$	Voltage at $V_{FB}$ Pin	$I_{OUT} = 0\text{A}$ , $V_{OUT} = 1.5\text{V}$	●	0.594	0.60	0.606	V
$I_{FB}$	Current at $V_{FB}$ Pin	(Note 7)			-12	-25	nA
$V_{OVL}$	Feedback Overvoltage Lockout		●	0.65	0.67	0.69	V
$I_{TRACK/SS}$	Track Pin Soft-Start Pull-Up Current	$\text{TRACK/SS} = 0\text{V}$		1.0	1.2	1.4	$\mu\text{A}$
$t_{ON(MIN)}$	Minimum On-Time	(Note 3)			100		ns
$R_{FBHI}$	Resistor Between $V_{OUT\_LCL}$ and $V_{FB}$ Pins			60.05	60.40	60.75	k $\Omega$

### Remote Sense Amplifier

$V_{OSNS^+}$ , $V_{OSNS^-}$ CM RANGE	Common Mode Input Range	$V_{IN} = 12\text{V}$ , $RUN > 1.4\text{V}$		0		3.6	V
$V_{DIFF\_OUT(MAX)}$	Maximum $\text{DIFF\_OUT}$ Voltage	$I_{DIFF\_OUT} = 300\mu\text{A}$		$\text{INTV}_{CC} - 1.4$			V

## ELECTRICAL CHARACTERISTICS

The ● denotes the specifications which apply over the specified internal operating temperature range (Note 2), otherwise specifications are at  $T_A = 25^\circ\text{C}$ .  $V_{IN} = 12\text{V}$ , per the typical application in Figure 22.

SYMBOL	PARAMETER	CONDITIONS	MIN	TYP	MAX	UNITS
$V_{OS}$	Input Offset Voltage	$V_{OSNS}^+ = V_{DIFF\_OUT} = 1.5\text{V}$ , $I_{DIFF\_OUT} = 100\mu\text{A}$			2	mV
$A_V$	Differential Gain	(Note 7)		1		V/V
SR	Slew Rate	(Note 6)		2		V/ $\mu\text{s}$
GBP	Gain Bandwidth Product	(Note 6)		3		MHz
CMRR	Common Mode Rejection	(Note 7)		60		dB
$I_{DIFF\_OUT}$	DIFF_OUT Current	Sourcing	2			mA
PSRR	Power Supply Rejection Ratio	$5\text{V} < V_{IN} < 20\text{V}$ (Note 7)		100		dB
$R_{IN}$	Input Resistance	$V_{OSNS}^+$ to GND		80		k $\Omega$
<b>PGOOD Output</b>						
$V_{PGOOD}$	PGOOD Trip Level	$V_{FB}$ With Respect to Set Output $V_{FB}$ Ramping Negative $V_{FB}$ Ramping Positive		-10 10		% %
$V_{PGL}$	PGOOD Voltage Low	$I_{PGOOD} = 2\text{mA}$		0.1	0.3	V
<b>INTV<sub>CC</sub> Linear Regulator</b>						
$V_{INTVCC}$	Internal $V_{CC}$ Voltage	$6\text{V} < V_{IN} < 20\text{V}$	4.8	5	5.2	V
$V_{INTVCC}$ Load Reg	INTV <sub>CC</sub> Load Regulation	$I_{CC} = 0$ to $50\text{mA}$		0.5		%
$V_{EXTVCC}$	External $V_{CC}$ Switchover	EXTV <sub>CC</sub> Ramping Positive	● 4.5	4.7		V
VLDO Ext	EXTV <sub>CC</sub> Voltage Drop	$I_{CC} = 25\text{mA}$ , $V_{EXTVCC} = 5\text{V}$		50	100	mV
<b>Oscillator and Phase-Locked Loop</b>						
$f_{SYNC}$	Frequency Sync Capture Range	MODE_PLLIN Clock Duty Cycle = 50%	250		800	kHz
$f_{NOM}$	Nominal Frequency	$V_{fSET} = 1.2\text{V}$	450	500	550	kHz
$f_{LOW}$	Lowest Frequency	$V_{fSET} = 0\text{V}$	210	250	290	kHz
$f_{HIGH}$	Highest Frequency	$V_{fSET} \geq 2.4\text{V}$	700	770	850	kHz
$I_{FREQ}$	Frequency Set Current		9	10	11	$\mu\text{A}$
$R_{MODE\_PLLIN}$	MODE_PLLIN Input Resistance			250		k $\Omega$
$V_{IH\_MODE\_PLLIN}$	Clock Input Level High		2.0			V
$V_{IL\_MODE\_PLLIN}$	Clock Input Level Low				0.8	V
<b>Temperature Diode</b>						
$V_{TEMP}$	TEMP Diode Voltage	$I_{TEMP} = 100\mu\text{A}$		0.6		V
TC $V_{TEMP}$	Temperature Coefficient		●	-2.0		mV/ $^\circ\text{C}$

**Note 1:** Stresses beyond those listed under Absolute Maximum Ratings may cause permanent damage to the device. Exposure to any Absolute Maximum Rating condition for extended periods may affect device reliability and lifetime.

**Note 2:** The LTM4637 is tested under pulsed load conditions such that  $T_J \approx T_A$ . The LTM4637E is guaranteed to meet performance specifications over the  $0^\circ\text{C}$  to  $125^\circ\text{C}$  internal operating temperature range. Specifications over the  $-40^\circ\text{C}$  to  $125^\circ\text{C}$  internal operating temperature range are assured by design, characterization and correlation with statistical process controls. The LTM4637I is guaranteed to meet specifications over the full  $-40^\circ\text{C}$  to  $125^\circ\text{C}$  internal operating temperature range. Note that the maximum ambient temperature consistent with these specifications is

determined by specific operating conditions in conjunction with board layout, the rated package thermal resistance and other environmental factors.

**Note 3:** The minimum on-time condition is specified for a peak-to-peak inductor ripple current of ~40% of  $I_{MAX}$  Load. (See the Applications Information section)

**Note 4:** See output current derating curves for different  $V_{IN}$ ,  $V_{OUT}$  and  $T_A$ .

**Note 5:** Limit current into the RUN pin to less than 2mA.

**Note 6:** Guaranteed by design.

**Note 7:** 100% tested at wafer level.

# TYPICAL PERFORMANCE CHARACTERISTICS

**Efficiency vs Load Current with 5V<sub>IN</sub>**

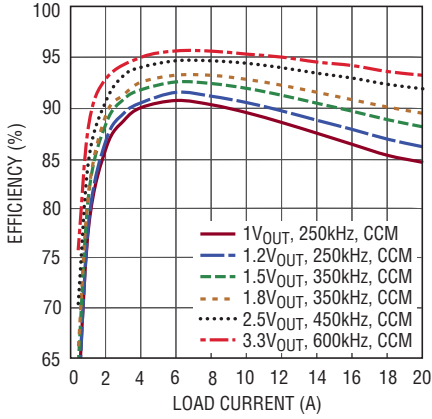

4637 G01

**Efficiency vs Load Current with 8V<sub>IN</sub> (Limit 5V Output to 15A)**

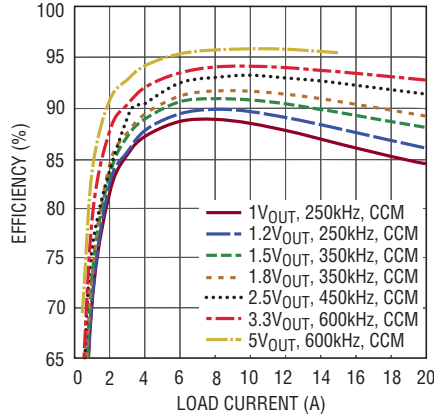

4637 G02

**Efficiency vs Load Current with 12V<sub>IN</sub> (Limit 5V Output to 15A)**

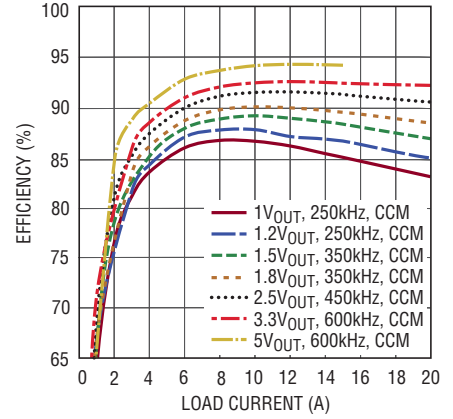

4637 G03

**Burst Mode Efficiency vs Load Current**

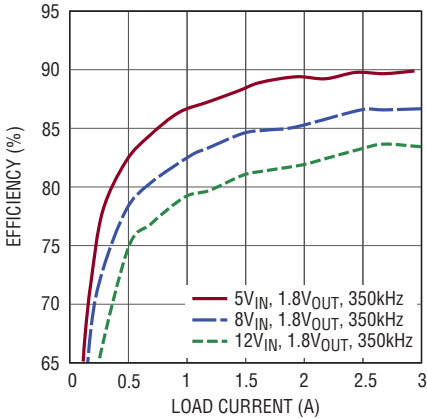

4637 G04

**Pulse-Skipping Mode Efficiency vs Load Current**

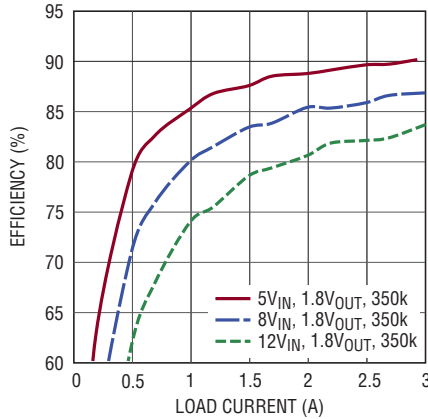

4637 G05

**1V Transient Response**

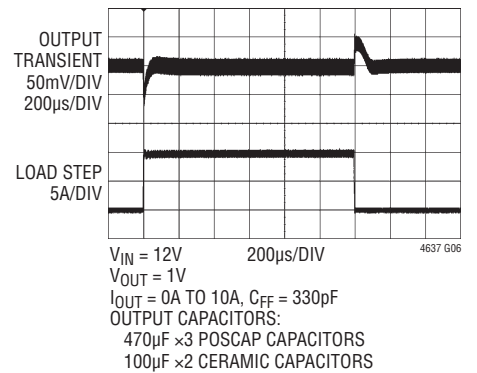

4637 G06

**1.2V Transient Response**

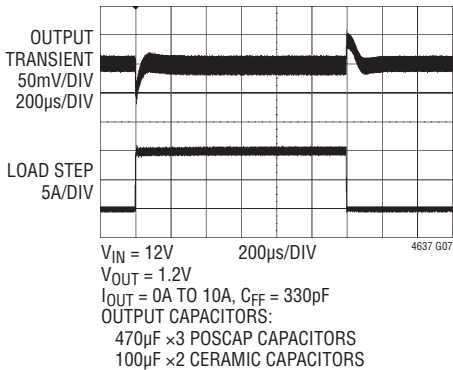

4637 G07

**1.5V Transient Response**

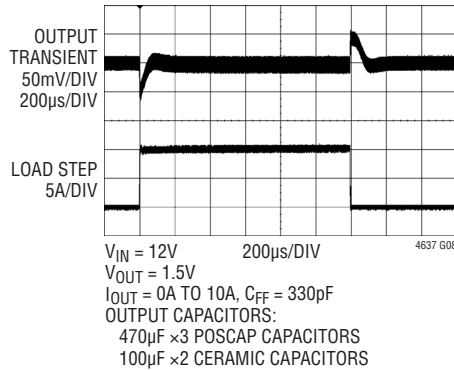

4637 G08

**1.8V Transient Response**

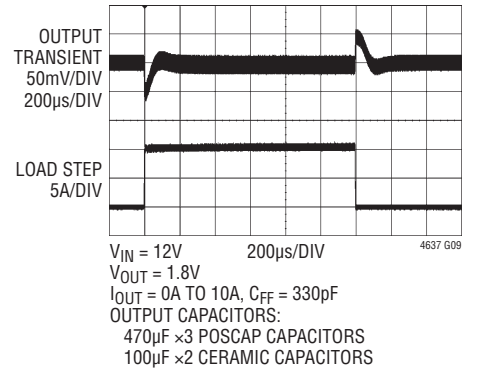

4637 G09

## TYPICAL PERFORMANCE CHARACTERISTICS

### 2.5V Transient Response

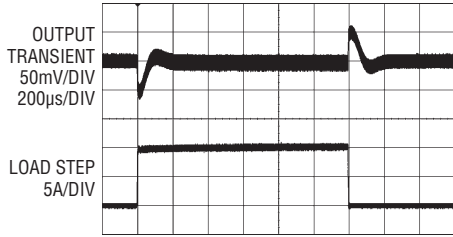

$V_{IN} = 12V$  200µs/DIV 4637 G10  
 $V_{OUT} = 2.5V$   
 $I_{OUT} = 0A$  TO  $10A$ ,  $C_{FF} = 330pF$   
 OUTPUT CAPACITORS:  
 470µF ×3 POSCAP CAPACITORS  
 100µF ×2 CERAMIC CAPACITORS

### 3.3V Transient Response

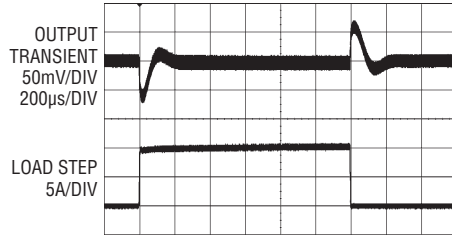

$V_{IN} = 12V$  200µs/DIV 4637 G11  
 $V_{OUT} = 3.3V$   
 $I_{OUT} = 0A$  TO  $10A$ ,  $C_{FF} = 330pF$   
 OUTPUT CAPACITORS:  
 470µF ×3 POSCAP CAPACITORS  
 100µF ×2 CERAMIC CAPACITORS

### 5V Transient Response

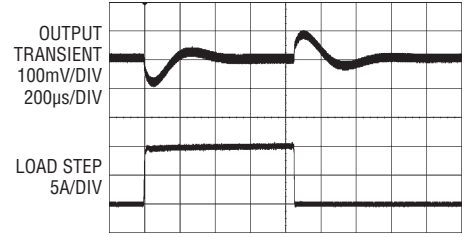

$V_{IN} = 12V$  200µs/DIV 4637 G12  
 $V_{OUT} = 5V$   
 $I_{OUT} = 0A$  TO  $10A$ ,  $C_{FF} = 330pF$   
 OUTPUT CAPACITORS:  
 470µF ×3 POSCAP CAPACITORS  
 100µF ×2 CERAMIC CAPACITORS

### Turn-On No Load

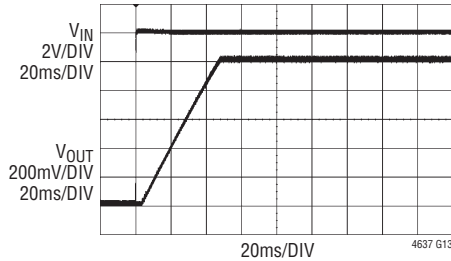

12V to 1.5V AT 0A LOAD  
 TRACK/SS = 0.1µF 4637 G13

### Turn-On 20A Load

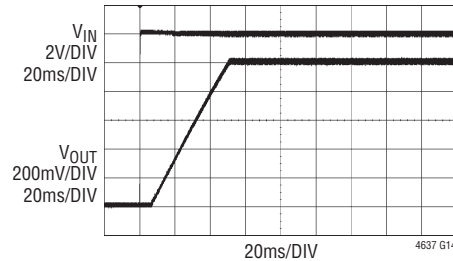

12V to 1.5V AT 20A LOAD  
 TRACK/SS = 0.1µF 4637 G14

### Short-Circuit Protection No Load

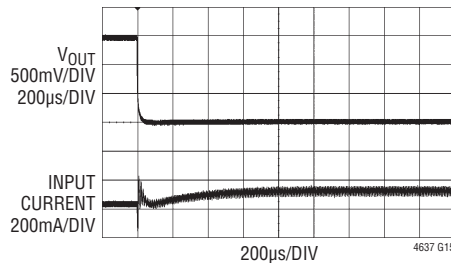

12V to 1.5V AT 0A LOAD  
 TRACK/SS = 0.1µF 4637 G15

### Short-Circuit Protection with 20A Load

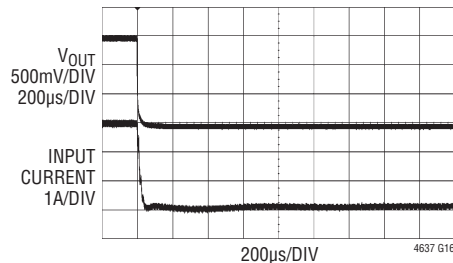

12V to 1.5V AT 20A LOAD  
 TRACK/SS = 0.1µF 4637 G16

## PIN FUNCTIONS



PACKAGE ROW AND COLUMN LABELING MAY VARY AMONG  $\mu$ Module PRODUCTS. REVIEW EACH PACKAGE LAYOUT CAREFULLY.

**V<sub>IN</sub> (A1-A6, B1-B6, C1-C6):** Power Input Pins. Apply input voltage between these and GND pins. Recommend placing input decoupling capacitance directly between V<sub>IN</sub> and GND pins.

**INTV<sub>CC</sub> (A7, D9)** Internal 5V LDO for Driving the Control Circuitry and the Power MOSFET Drivers. Both pins are internally connected. The 5V LDO has a 100mA current limit. INTV<sub>CC</sub> is controlled and enabled when RUN is activated high.

**MODE\_PLLIN (A8):** Forced Continuous Mode, Burst Mode Operation, or Pulse-Skipping Mode Selection Pin and External Synchronization Input to Phase Detector Pin. Connect this pin to INTV<sub>CC</sub> to enable pulse-skipping mode. Connect to ground to enable forced continuous mode. Floating this pin will enable Burst Mode operation. A clock on this pin will enable synchronization with forced continuous operation. See the Applications Information section.

**TRACK/SS (A9):** Output Voltage Tracking Pin and Soft-Start Inputs. The pin has a 1.2 $\mu$ A pull-up current source. A capacitor from this pin to ground will set a soft-start ramp rate. In tracking, the regulator output can be tracked to a different voltage. See the Applications Information section.

**RUN: (A10)** Run Control Pin. A voltage above 1.4V will turn on the module. A 5.1V Zener diode to ground is internal to the module for limiting the voltage on the RUN pin to 5V, and allowing a pull-up resistor to V<sub>IN</sub> for enabling the device. Limit current into the RUN pin to  $\leq 2$ mA.

**COMP (A11):** Current Control Threshold and Error Amplifier Compensation Point. The current comparator threshold increases with this control voltage. Tie all COMP pins together for parallel operation. The device is internally compensated.

**MTP1, MTP2, MTP3, MTP4, MTP5, MTP6, MTP7, (A12, B11, C10, C11, C12, D11, D12):** Extra mounting pads used for increased solder integrity strength. Leave floating.

**GND (B7, B9, C7, C9, D1-D6, D8, E1-E7, E9, F1-F9, G1-G9, H1-H9):** Power Ground Pins for Both Input and Output.

**f<sub>SET</sub> (B12):** A resistor can be applied from this pin to ground to set the operating frequency, or a DC voltage can be applied to set the frequency. See the Applications Information section.

**TEMP (D10):** Temperature Monitor. See Applications Information section.

**EXTV<sub>CC</sub> (E12):** External power input to an internal control switch allows an external source greater than 4.7V, but less than 6V to supply IC power and bypass the internal INTV<sub>CC</sub> LDO. EXTV<sub>CC</sub> must be less than V<sub>IN</sub> at all times during power-on and power-off sequences. See the Applications Information section. 5V output application can connect the 5V output to this pin to improve efficiency. The 5V output is connected to EXTV<sub>CC</sub> in the 5V derating curves.

**PGOOD (F11, G12):** Output Voltage Power Good Indicator. Open-drain logic output is pulled to ground when the output voltage exceeds a  $\pm 10\%$  regulation window. Both pins are tied together internally.

**V<sub>FB</sub> (F12):** The Negative Input of the Error Amplifier. Internally, this pin is connected to V<sub>OUT\_LCL</sub> with a 60.4k precision resistor. Different output voltages can be programmed with an additional resistor between V<sub>FB</sub> and ground pins. In PolyPhase<sup>®</sup> operation, tying the V<sub>FB</sub> pins together allows for parallel operation. See the Applications Information section.

**SGND (G11, H11, H12):** Signal Ground Pin. Return ground path for all analog and low power circuitry. Tie a single connection to the output capacitor GND. See layout guidelines in Figure 21.

**V<sub>OUT</sub> (J1-J10, K1-K11, L1-L11, M1-M11):** Power Output Pins. Apply output load between these and GND pins. Recommend placing output decoupling capacitance between these pins and GND pins. Review Table 5.

**V<sub>OSNS</sub><sup>+</sup> (J12) (+)** Input to the Remote Sense Amplifier. This pin connects to the output remote sense point. The remote sense amplifier can be used for V<sub>OUT</sub>  $\leq 3.3$ V. Connect to ground when not used.

## PIN FUNCTIONS

**DIFF\_OUT: (K12)** Output of the Remote Sense Amplifier. This pin connects to the  $V_{OUT\_LCL}$  pin for remote sense applications. Otherwise float when not used. The remote sense amplifier can be used for  $V_{OUT} \leq 3.3V$ .

**$V_{OUT\_LCL}$ : (L12)** This pin connects to  $V_{OUT}$  through a  $1M\Omega$  resistor, and to  $V_{FB}$  with a  $60.4k\Omega$  resistor. The remote sense amplifier output DIFF\_OUT is connected to  $V_{OUT\_LCL}$ , and drives the  $60.4k\Omega$  top feedback resistor in remote sensing

applications. When the remote sense amplifier is used, DIFF\_OUT effectively eliminates the  $1M\Omega$  from  $V_{OUT}$  to  $V_{OUT\_LCL}$ . When the remote sense amplifier is not used, then connect  $V_{OUT\_LCL}$  to  $V_{OUT}$  directly.

**$V_{OSNS}^-$ : (M12) (-)** Input to the Remote Sense Amplifier. This pin connects to the ground remote sense point. The remote sense amplifier can be used for  $V_{OUT} \leq 3.3V$ . Connect to ground when not used.

## BLOCK DIAGRAM

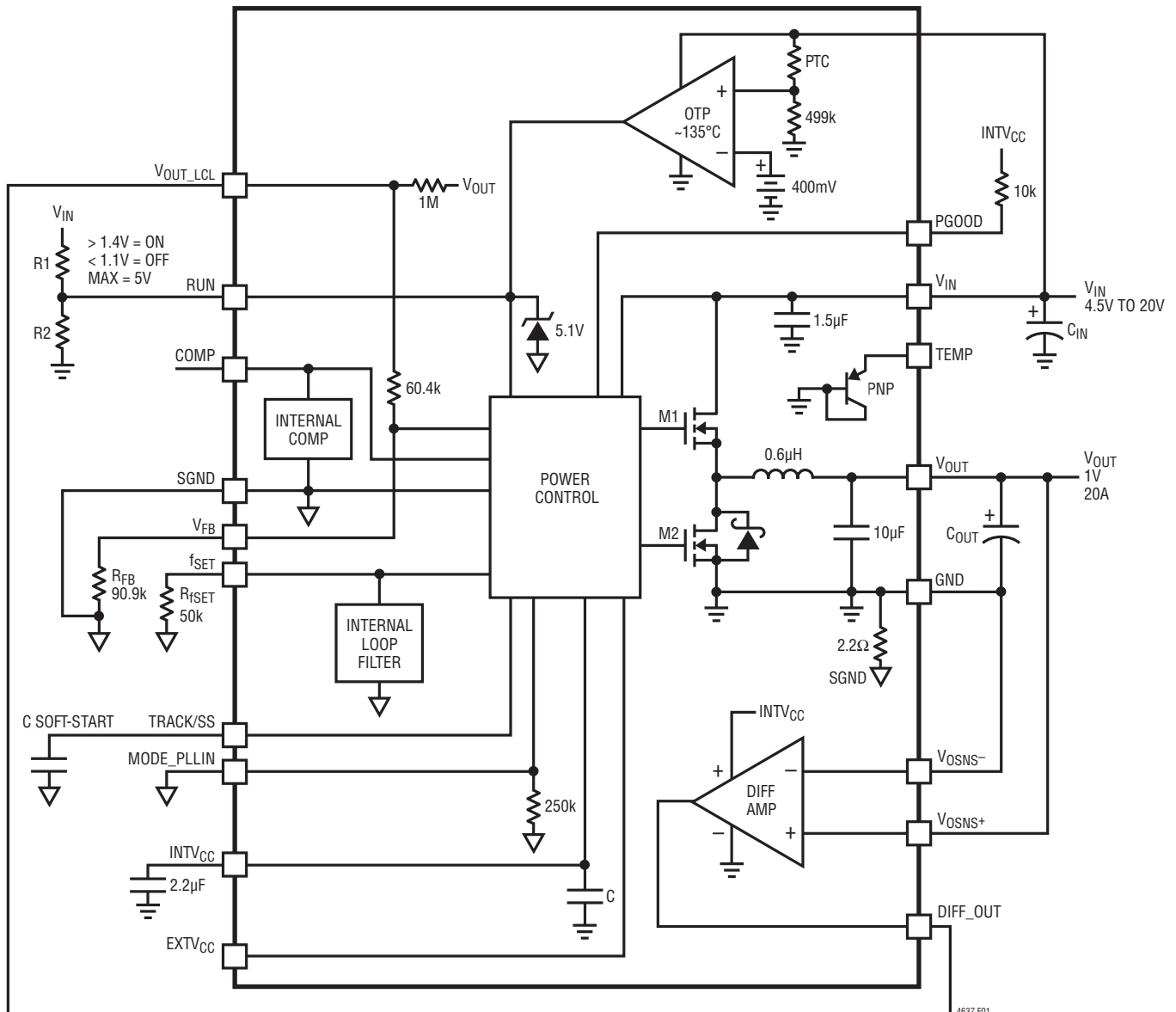

Figure 1. Simplified LTM4637 Block Diagram

## DECOUPLING REQUIREMENTS $T_A = 25^\circ\text{C}$ . Use Figure 1 configuration.

SYMBOL	PARAMETER	CONDITIONS	MIN	TYP	MAX	UNITS
$C_{IN}$	External Input Capacitor Requirement ( $V_{IN} = 4.5\text{V}$ to $20\text{V}$ , $V_{OUT} = 1.5\text{V}$ )	$I_{OUT} = 20\text{A}$ , $4 \times 22\mu\text{F}$ Ceramic X7R Capacitors (See Table 5)		88		$\mu\text{F}$
$C_{OUT}$	External Output Capacitor Requirement ( $V_{IN} = 4.5\text{V}$ to $20\text{V}$ , $V_{OUT} = 1.5\text{V}$ )	$I_{OUT} = 20\text{A}$ (See Table 5)		400		$\mu\text{F}$

## OPERATION

### Power Module Description

The LTM4637 is a high performance single output stand-alone nonisolated switching mode DC/DC power supply. It can provide a 20A output with few external input and output capacitors. This module provides precisely regulated output voltages programmable via external resistors from  $0.6V_{DC}$  to  $5.5V_{DC}$  over a 4.5V to 20V input range. The typical application schematic is shown in Figure 22.

The LTM4637 has an integrated constant-frequency current mode regulator, power MOSFETs,  $0.6\mu\text{H}$  inductor, and other supporting discrete components. The switching frequency range is from 250kHz to 770kHz, and the typical operating frequency is shown in Table 5 for each  $V_{OUT}$ . For switching noise-sensitive applications, it can be externally synchronized from 250kHz to 800kHz, subject to minimum on-time limitations. A single resistor is used to program the frequency. See the Applications Information section.

With current mode control and internal feedback loop compensation, the LTM4637 module has sufficient stability margins and good transient performance with a wide range of output capacitors, even with all ceramic output capacitors.

Current mode control provides cycle-by-cycle fast current limit in an overcurrent condition. An internal overvoltage monitor protects the output voltage in the event of an overvoltage  $>10\%$ . The top MOSFET is turned off and the bottom MOSFET is turned on until the output is cleared.

Overtemperature protection will turn off the regulator's RUN pin at  $\sim 130^\circ\text{C}$  to  $137^\circ\text{C}$ . See Applications Information section.

Pulling the RUN pin below 1.1V forces the regulator into a shutdown state. The TRACK/SS pin is used for programming the output voltage ramp and voltage tracking during start-up. See the Applications Information section.

The LTM4637 is internally compensated to be stable over all operating conditions. Table 5 provides a guideline for input and output capacitances for several operating conditions. LTpowerCAD is available for transient and stability analysis. The  $V_{FB}$  pin is used to program the output voltage with a single external resistor to ground.

A remote sense amplifier is provided for accurately sensing output voltages  $\leq 3.3\text{V}$  at the load point.

Multiphase operation can be easily employed with the synchronization inputs using an external clock source. See Figure 23.

High efficiency at light loads can be accomplished with selectable Burst Mode operation using the MODE\_PLLIN pin. These light load features will accommodate battery operation. Efficiency graphs are provided for light load operation in the Typical Performance Characteristics section.

A TEMP pin is provided to allow the internal device temperature to be monitored using an onboard diode connected PNP transistor. This diode connected PNP transistor is grounded in the module and can be used as a general temperature monitor using a device that is designed to monitor the single-ended connection.

## APPLICATIONS INFORMATION

The typical LTM4637 application circuit is shown in Figure 22. External component selection is primarily determined by the maximum load current and output voltage. Refer to Table 5 for specific external capacitor requirements for particular applications.

### $V_{IN}$ to $V_{OUT}$ Step-Down Ratios

There are restrictions in the  $V_{IN}$  to  $V_{OUT}$  step-down ratio that can be achieved for a given input voltage. The duty cycle is 94% typical at 500kHz operation. The  $V_{IN}$  to  $V_{OUT}$  minimum dropout is a function of load current and operation at very low input voltage and high duty cycle applications. At very low duty cycles the minimum 100ns on-time must be maintained. See the PLL, Frequency Adjustment and Synchronization section and temperature derating curves.

### Output Voltage Programming

The PWM controller has an internal  $0.6V \pm 1\%$  reference voltage. As shown in the Block Diagram, a 60.4k internal feedback resistor connects the  $V_{OUT\_LCL}$  and  $V_{FB}$  pins together. When the remote sense amplifier is used, then  $DIFF\_OUT$  is connected to the  $V_{OUT\_LCL}$  pin. If the remote sense amplifier is not used, then  $V_{OUT\_LCL}$  connects to  $V_{OUT}$ . The output voltage will default to 0.6V with no feedback resistor. Adding a resistor  $R_{FB}$  from  $V_{FB}$  to ground programs the output voltage:

$$V_{OUT} = 0.6V \cdot \frac{60.4k + R_{FB}}{R_{FB}}$$

**Table 1.  $V_{FB}$  Resistor Table vs Various Output Voltages**

$V_{OUT}$ (V)	0.6	1.0	1.2	1.5	1.8	2.5	3.3	5.0
$R_{FB}$ (k)	Open	90.9	60.4	40.2	30.1	19.1	13.3	8.25

For parallel operation of N LTM4637s, the following equation can be used to solve for  $R_{FB}$ :

$$R_{FB} = \frac{60.4k / N}{\frac{V_{OUT}}{0.6V} - 1}$$

Tie the  $V_{FB}$  pins together for each parallel output. The COMP pins must be tied together also.

### Input Capacitors

The LTM4637 module should be connected to a low AC-impedance DC source. Additional input capacitors are needed for the RMS input ripple current rating. The  $I_{CIN(RMS)}$  equation which follows can be used to calculate the input capacitor requirement. Typically 22 $\mu$ F X7R ceramics are a good choice with RMS ripple current ratings of ~2A each. A 47 $\mu$ F to 100 $\mu$ F surface mount aluminum electrolytic bulk capacitor can be used for more input bulk capacitance. This bulk input capacitor is only needed if the input source impedance is compromised by long inductive leads, traces or not enough source capacitance. If low impedance power planes are used, then this bulk capacitor is not needed.

For a buck converter, the switching duty cycle can be estimated as:

$$D = \frac{V_{OUT}}{V_{IN}}$$

Without considering the inductor ripple current, for each output the RMS current of the input capacitor can be estimated as:

$$I_{CIN(RMS)} = \frac{I_{OUT(MAX)}}{\eta\%} \cdot \sqrt{D \cdot (1-D)}$$

where  $\eta\%$  is the estimated efficiency of the power module. The bulk capacitor can be a switcher-rated aluminum electrolytic capacitor or a Polymer capacitor.

### Output Capacitors

The LTM4637 is designed for low output voltage ripple noise. The bulk output capacitors defined as  $C_{OUT}$  are chosen with low enough effective series resistance (ESR) to meet the output voltage ripple and transient requirements.  $C_{OUT}$  can be a low ESR tantalum capacitor, low ESR Polymer capacitor or ceramic capacitors. The typical output capacitance range is from 200 $\mu$ F to 800 $\mu$ F. Additional output filtering may be required by the system designer if further reduction of output ripple or dynamic transient spikes is required. Table 5 shows a matrix of different output voltages and output capacitors to minimize the voltage droop and overshoot during a 10A/ $\mu$ s transient. The table optimizes total equivalent ESR and total bulk capacitance

## APPLICATIONS INFORMATION

to optimize the transient performance. Stability criteria are considered in the Table 5 matrix, and LTpowerCAD® is available for stability analysis. Multiphase operation will reduce effective output ripple as a function of the number of phases. [Application Note 77](#) discusses this noise reduction versus output ripple current cancellation, but the output capacitance should be considered carefully as a function of stability and transient response. LTpowerCAD can be used to calculate the output ripple reduction as the number of implemented phases increases by N times.

### Burst Mode Operation

The LTM4637 is capable of Burst Mode operation in which the power MOSFETs operate intermittently based on load demand, thus saving quiescent current. For applications where maximizing the efficiency at very light loads is a high priority, Burst Mode operation should be applied. To enable Burst Mode operation, simply float the MODE\_PLLIN pin. During Burst Mode operation, the peak current of the inductor is set to approximately 30% of the maximum peak current value in normal operation even though the voltage at the COMP pin indicates a lower value. The voltage at the COMP pin drops when the inductor's average current is greater than the load requirement. As the COMP voltage drops below 0.5V, the burst comparator trips, causing the internal sleep line to go high and turn off both power MOSFETs.

In sleep mode, the internal circuitry is partially turned off, reducing the quiescent current. The load current is now being supplied from the output capacitors. When the output voltage drops, causing COMP to rise, the internal sleep line goes low, and the LTM4637 resumes normal operation. The next oscillator cycle will turn on the top power MOSFET and the switching cycle repeats.

### Pulse-Skipping Mode Operation

In applications where low output ripple and high efficiency at intermediate currents are desired, pulse-skipping mode should be used. Pulse-skipping operation allows the LTM4637 to skip cycles at low output loads, thus increasing efficiency by reducing switching loss. Tying the MODE\_PLLIN pin to INTV<sub>CC</sub> enables pulse-skipping operation. With pulse-skipping mode at light load, the internal current comparator may remain tripped for several

cycles, thus skipping operation cycles. This mode has lower ripple than Burst Mode operation and maintains a higher frequency operation than Burst Mode operation.

### Forced Continuous Operation

In applications where fixed frequency operation is more critical than low current efficiency, and where the lowest output ripple is desired, forced continuous operation should be used. Forced continuous operation can be enabled by tying the MODE\_PLLIN pin to ground. In this mode, inductor current is allowed to reverse during low output loads, the COMP voltage is in control of the current comparator threshold throughout, and the top MOSFET always turns on with each oscillator pulse. During start-up, forced continuous mode is disabled and inductor current is prevented from reversing until the LTM4637's output voltage is in regulation.

### Multiphase Operation

For applications that demand more than 20A of load current, multiple LTM4637 devices can be paralleled to provide more output current without increasing input and output ripple voltage. The MODE\_PLLIN pin allows the LTM4637 to be synchronized to an external clock and the internal phase-locked loop allows the LTM4637 to lock onto input clock phase as well. The f<sub>SET</sub> resistor is selected for normal frequency, then the incoming clock can synchronize the device over the specified range. See Figure 24 for a synchronizing example circuit.

A multiphase power supply significantly reduces the amount of ripple current in both the input and output capacitors. The RMS input ripple current is reduced by, and the effective ripple frequency is multiplied by, the number of phases used (assuming that the input voltage is greater than the number of phases used times the output voltage). The output ripple amplitude is also reduced by the number of phases used. See [Application Note 77](#).

The LTM4637 device is an inherently current mode controlled device, so parallel modules will have good current sharing. This will balance the thermals in the design. Tie the COMP and V<sub>FB</sub> pins of each LTM4637 together to share the current evenly. Figure 24 shows a schematic of the parallel design.

## APPLICATIONS INFORMATION

### Input RMS Ripple Current Cancellation

[Application Note 77](#) provides a detailed explanation of multiphase operation. The input RMS ripple current cancellation mathematical derivations are presented, and a graph is displayed representing the RMS ripple current reduction as a function of the number of interleaved phases (see Figure 2).

### PLL, Frequency Adjustment and Synchronization

The LTM4637 switching frequency is set by a resistor ( $R_{fSET}$ ) from the  $f_{SET}$  pin to signal ground. A  $10\mu A$  current ( $I_{FREQ}$ ) flowing out of the  $f_{SET}$  pin through  $R_{fSET}$  develops a voltage on  $f_{SET}$ .  $R_{fSET}$  can be calculated as:

$$R_{fSET} = \left[ \frac{FREQ}{500kHz/V} + 0.2V \right] \frac{1}{10\mu A}$$

The relationship of  $f_{SET}$  voltage to switching frequency is shown in Figure 3. For low output voltages from 0.6V to 1.2V, 250kHz operation is an optimal frequency for the best power conversion efficiency while maintaining the

inductor current to about 30% to 40% of maximum load current. For output voltages from 1.5V to 1.8V, 350kHz is optimal. For output voltages from 2.5V to 5V, 500kHz is optimal. See efficiency graphs for optimal frequency set point. Limit 5V output to 15A.

The LTM4637 can be synchronized from 250kHz to 800kHz with an input clock that has a high level above

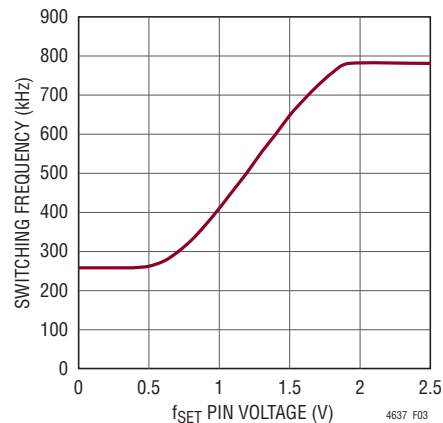

**Figure 3. Relationship Between Switching Frequency and Voltage at the  $f_{SET}$  Pin**

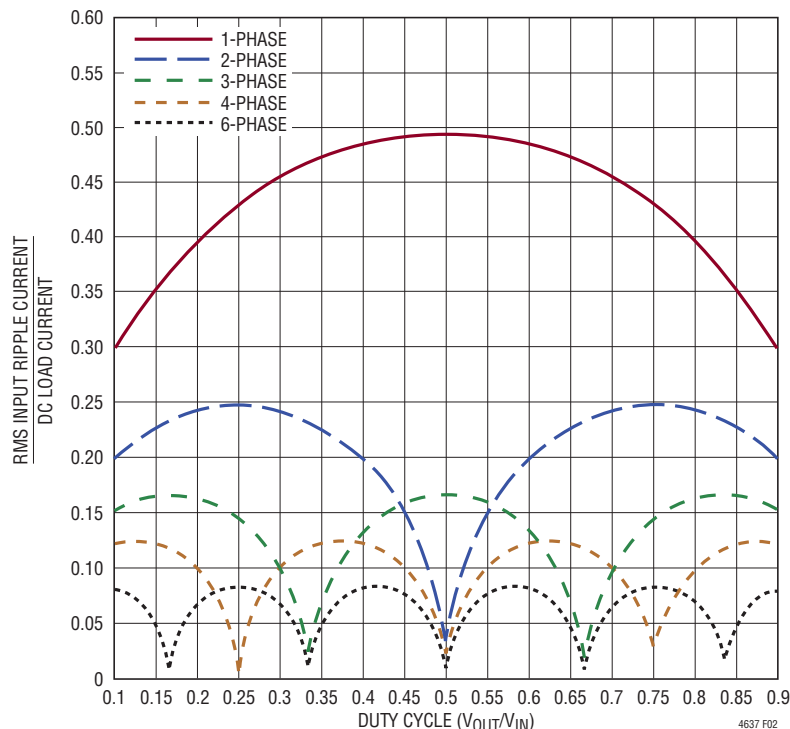

**Figure 2. Normalized Input RMS Ripple Current vs Duty Cycle for One to Six  $\mu$ Module Regulators (Phases)**

## APPLICATIONS INFORMATION

2V and a low level below 0.8V. See the Typical Application section for synchronization examples. The LTM4637 minimum on-time is limited to approximately 100ns. Guardband the on-time to 110ns. The on-time can be calculated as:

$$t_{\text{ON(MIN)}} = \frac{1}{\text{FREQ}} \cdot \left( \frac{V_{\text{OUT}}}{V_{\text{IN}}} \right)$$

### Output Voltage Tracking

Output voltage tracking can be programmed externally using the TRACK/SS pin. The output can be tracked up and down with another regulator. The main regulator's output is divided down with an external resistor divider that is the same as the subordinate regulator's feedback divider to implement coincident tracking. The LTM4637 uses an accurate 60.4k resistor internally for the top feedback resistor. Figure 4 shows an example of coincident tracking.

$$V_{\text{OUT(SUBORDINATE)}} = \left( 1 + \frac{60.4\text{k}}{R_{\text{TA}}} \right) \cdot V_{\text{TRACK}}$$

$V_{\text{TRACK}}$  is the track ramp applied to the subordinate's track pin.  $V_{\text{TRACK}}$  has a control range of 0V to 0.6V, or the internal reference voltage. When the main's output is divided down with the same resistor values used to set the subordinate's output, then the subordinate will coincident track with the main until it reaches its final value. The main will continue to its final value from the subordinate's regulation point (see Figure 5). Voltage tracking is disabled when  $V_{\text{TRACK}}$  is more than 0.6V.  $R_{\text{TA}}$  in Figure 4 will be equal to  $R_{\text{FB}}$  for coincident tracking.

The TRACK/SS pin of the main can be controlled by an external ramp or the soft-start function of that regulator can be used to develop that main ramp. The LTM4637 can be used as a main device by setting the ramp rate on its track pin using a soft-start capacitor. A 1.2μA current source is used to charge the soft-start capacitor. The following equation can be used:

$$t_{\text{SOFT-START}} = 0.6\text{V} \cdot \left( \frac{C_{\text{SS}}}{1.2\mu\text{A}} \right)$$

Ratiometric tracking can be achieved by a few simple calculations and the slew rate value applied to the main's TRACK/SS pin. As mentioned above, the TRACK/SS pin has a control range from 0V to 0.6V. The main's TRACK/SS pin slew rate is directly equal to the main's output slew rate in volts/time. The equation:

$$\frac{\text{MR}}{\text{SR}} \cdot 60.4\text{k} = R_{\text{TB}}$$

where MR is the main's output slew rate and SR is the subordinate's output slew rate in volts/time. When coincident tracking is desired, then MR and SR are equal, thus  $R_{\text{TB}}$  is equal to 60.4k.  $R_{\text{TA}}$  is derived from equation:

$$R_{\text{TA}} = \frac{0.6\text{V}}{\frac{V_{\text{FB}}}{60.4\text{k}} + \frac{V_{\text{FB}}}{R_{\text{FB}}} - \frac{V_{\text{TRACK}}}{R_{\text{TB}}}}$$

where  $V_{\text{FB}}$  is the feedback voltage reference of the regulator, and  $V_{\text{TRACK}}$  is 0.6V. Since  $R_{\text{TB}}$  is equal to the 60.4k top feedback resistor of the subordinate regulator in equal slew rate or coincident tracking, then  $R_{\text{TA}}$  is equal to  $R_{\text{FB}}$  with  $V_{\text{FB}} = V_{\text{TRACK}}$ . Therefore  $R_{\text{TB}} = 60.4\text{k}$ , and  $R_{\text{TA}} = 60.4\text{k}$  in Figure 4.

In ratiometric tracking, a different slew rate may be desired for the subordinate regulator.  $R_{\text{TB}}$  can be solved for when SR is slower than MR. Make sure that the subordinate supply slew rate is chosen to be fast enough so that the subordinate output voltage will reach its final value before the main output.

For example, MR = 1.5V/ms, and SR = 1.2V/ms. Then  $R_{\text{TB}} = 75\text{k}$ . Solve for  $R_{\text{TA}}$  to equal 51.1k.

For applications that do not require tracking or sequencing, simply tie the TRACK/SS pin to INTV<sub>CC</sub> to let RUN control the turn on/off. When the RUN pin is below its threshold or the  $V_{\text{IN}}$  undervoltage lockout, then TRACK/SS is pulled low.

### Overcurrent and Overvoltage Protection

The LTM4637 has overcurrent protection (OCP) in a short circuit. The internal current comparator threshold folds back during a short to reduce the output current. An overvoltage condition (OVP) above 10% of the regulated

Rev. D

APPLICATIONS INFORMATION

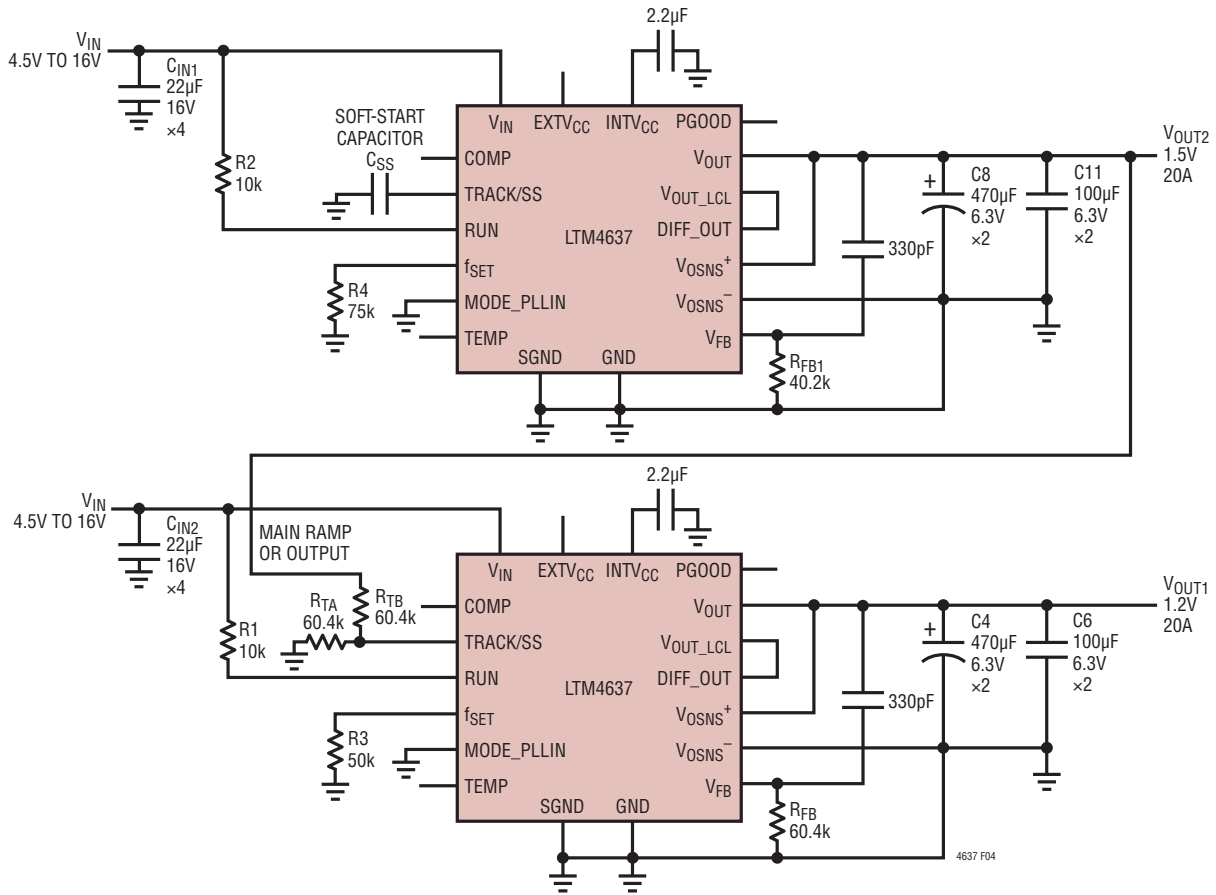

Figure 4. Dual Outputs (1.5V and 1.2V) with Tracking

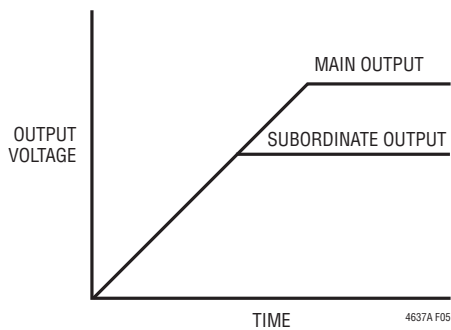

Figure 5. Output Voltage Coincident Tracking Characteristics

output voltage will force the top MOSFET off and the bottom MOSFET on until the condition is cleared. Foldback current limiting is disabled during soft-start or tracking start-up.

Temperature Monitoring

A diode connected PNP transistor is used for the TEMP monitor function by monitoring its voltage over temperature. The temperature dependence of this diode voltage can be understood in the equation:

$$V_D = nV_T \ln\left(\frac{I_D}{I_S}\right)$$

where  $V_T$  is the thermal voltage ( $kT/q$ ), and  $n$ , the ideality factor, is 1 for the diode connected PNP transistor

## APPLICATIONS INFORMATION

being used in the LTM4637.  $I_S$  is expressed by the typical empirical equation:

$$I_S = I_0 \exp\left(\frac{-V_{G0}}{V_T}\right)$$

where  $I_0$  is a process and geometry dependent current, ( $I_0$  is typically around 20k orders of magnitude larger than  $I_S$  at room temperature) and  $V_{G0}$  is the band gap voltage of 1.2V extrapolated to absolute zero or  $-273^\circ\text{C}$ .

If we take the  $I_S$  equation and substitute into the  $V_D$  equation, then we get:

$$V_D = V_{G0} - \left(\frac{kT}{q}\right) \ln\left(\frac{I_0}{I_D}\right), \quad V_T = \frac{kT}{q}$$

The expression shows that the diode voltage decreases (linearly if  $I_0$  were constant) with increasing temperature and constant diode current. Figure 6 shows a plot of  $V_D$  vs Temperature over the operating temperature range of the LTM4637.

If we take this equation and differentiate it with respect to temperature T, then:

$$\frac{dV_D}{dT} = -\frac{V_{G0} - V_D}{T}$$

This  $dV_D/dT$  term is the temperature coefficient equal to about  $-2\text{mV/K}$  or  $-2\text{mV}/^\circ\text{C}$ . The equation is simplified for the first order derivation.

Solving for T,  $T = -(V_{G0} - V_D)/(dV_D/dT)$  provides the temperature.

1st Example: Figure 6 for  $27^\circ\text{C}$ , or 300K the diode voltage is 0.598V, thus,  $300\text{K} = -(1200\text{mV} - 598\text{mV})/ -2.0\text{mV/K}$

2nd Example: Figure 6 for  $75^\circ\text{C}$ , or 350K the diode voltage is 0.50V, thus,  $350\text{K} = -(1200\text{mV} - 500\text{mV})/ -2.0\text{mV/K}$

Converting the Kelvin scale to Celsius is simply taking the Kelvin temp and subtracting 273 from it.

A typical forward voltage is given in the Electrical Characteristics section of the data sheet, and Figure 6

is the plot of this forward voltage. Measure this forward voltage at  $27^\circ\text{C}$  to establish a reference point. Then using the above expression while measuring the forward voltage over temperature will provide a general temperature monitor. Connect a resistor between TEMP and  $V_{IN}$  to set the current to  $100\mu\text{A}$ . See Figure 22 for an example.

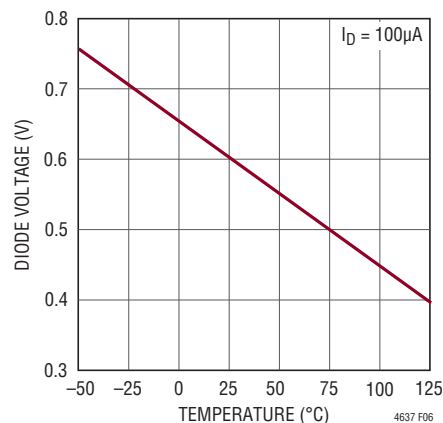

Figure 6. Diode Voltage  $V_D$  vs Temperature  $T$  ( $^\circ\text{C}$ )

### Overtemperature Protection

The internal overtemperature protection monitors the internal temperature of the module and shuts off the regulator at  $\sim 130^\circ\text{C}$  to  $137^\circ\text{C}$ . Once the regulator cools down the regulator will restart.

### Run Enable

The RUN pin is used to enable the power module or sequence the power module. The threshold is 1.25V, and the pin has an internal 5.1V Zener to protect the pin. The RUN pin can be used as an undervoltage lockout (UVLO) function by connecting a resistor divider from the input supply to the RUN pin:

$$V_{UVLO} = ((R1+R2)/R2) \cdot 1.25\text{V}$$

See Figure 1, Simplified Block Diagram.

### INTV<sub>CC</sub> Regulator

The LTM4637 has an internal low dropout regulator from  $V_{IN}$  called INTV<sub>CC</sub>. This regulator output has a  $2.2\mu\text{F}$  ceramic capacitor internal. An additional  $2.2\mu\text{F}$  ceramic capacitor is needed on this pin to ground. This regulator

## APPLICATIONS INFORMATION

powers the internal controller and MOSFET drivers. The gate driver current is ~20mA for 750kHz operation. The regulator loss can be calculated as:

$$(V_{IN} - 5V) \cdot 20\text{mA} = P_{LOSS}$$

EXTV<sub>CC</sub> external voltage source  $\geq 4.7V$  can be applied to this pin to eliminate the internal INTV<sub>CC</sub> LDO power loss and increase regulator efficiency. A 5V supply can be applied to run the internal circuitry and power MOSFET driver. If unused, leave pin floating. EXTV<sub>CC</sub> must be less than V<sub>IN</sub> at all times during power-on and power-off sequences.

### Stability Compensation

The LTM4637 has already been internally compensated for all output voltages. Table 5 is provided for most application requirements. LTpowerCAD is available for other control loop optimization.

### Thermal Considerations and Output Current Derating

The thermal resistances reported in the Pin Configuration section of the data sheet are consistent with those parameters defined by JESD51-12 and are intended for use with finite element analysis (FEA) software modeling tools that leverage the outcome of thermal modeling, simulation, and correlation to hardware evaluation performed on a  $\mu$ Module package mounted to a hardware test board. The motivation for providing these thermal coefficients is found in JESD51-12 (“Guidelines for Reporting and Using Electronic Package Thermal Information”).

Many designers may opt to use laboratory equipment and a test vehicle such as the demo board to predict the  $\mu$ Module regulator’s thermal performance in their application at various electrical and environmental operating conditions to compliment any FEA activities. Without FEA software, the thermal resistances reported in the Pin Configuration section are, in and of themselves, not relevant to providing guidance of thermal performance; instead, the derating curves provided in this data sheet can be used in a manner that yields insight and guidance pertaining to one’s application-usage, and can be adapted to correlate thermal performance to one’s own application.

The Pin Configuration section gives four thermal coefficients explicitly defined in JESD51-12; these coefficients are quoted or paraphrased below:

- 1  $\theta_{JA}$ , the thermal resistance from junction to ambient, is the natural convection junction-to-ambient air thermal resistance measured in a one cubic foot sealed enclosure. This environment is sometimes referred to as “still air” although natural convection causes the air to move. This value is determined with the part mounted to a 95mm  $\times$  76mm PCB with four layers.
- 2  $\theta_{JCbottom}$ , the thermal resistance from junction to the bottom of the product case, is determined with all of the component power dissipation flowing through the bottom of the package. In the typical  $\mu$ Module regulator, the bulk of the heat flows out the bottom of the package, but there is always heat flow out into the ambient environment. As a result, this thermal resistance value may be useful for comparing packages but the test conditions don’t generally match the user’s application.
- 3  $\theta_{JCtop}$ , the thermal resistance from junction to top of the product case, is determined with nearly all of the component power dissipation flowing through the top of the package. As the electrical connections of the typical  $\mu$ Module regulator are on the bottom of the package, it is rare for an application to operate such that most of the heat flows from the junction to the top of the part. As in the case of  $\theta_{JCbottom}$ , this value may be useful for comparing packages but the test conditions don’t generally match the user’s application.
- 4  $\theta_{JB}$ , the thermal resistance from junction to the printed circuit board, is the junction-to-board thermal resistance where almost all of the heat flows through the bottom of the  $\mu$ Module package and into the board, and is really the sum of the  $\theta_{JCbottom}$  and the thermal resistance of the bottom of the part through the solder joints and a portion of the board. The board temperature is measured a specified distance from the package.

A graphical representation of the aforementioned thermal resistances is given in Figure 7; blue resistances are contained within the  $\mu$ Module regulator, whereas green resistances are external to the  $\mu$ Module package.

## APPLICATIONS INFORMATION

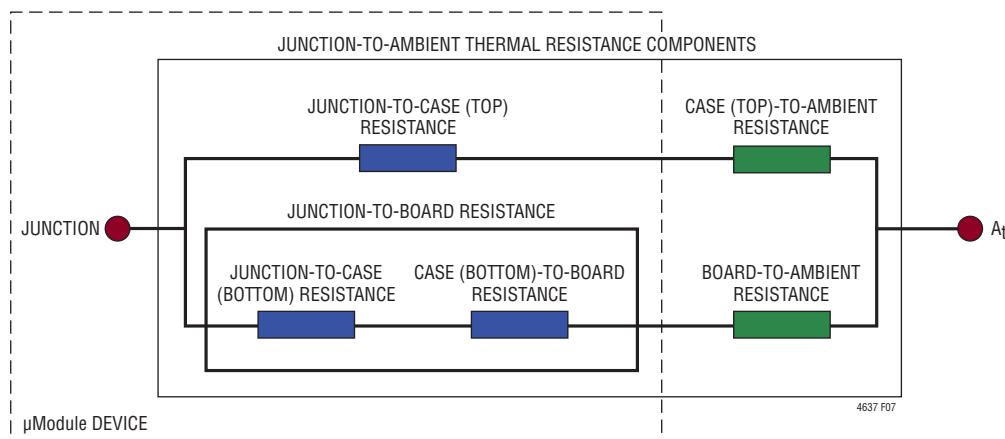

Figure 7. Graphical Representation of JESD51-12 Thermal Coefficients

As a practical matter, it should be clear to the reader that no individual or sub-group of the four thermal resistance parameters defined by JESD51-12 or provided in the Pin Configuration section replicates or conveys normal operating conditions of a  $\mu$ Module regulator. For example, in normal board-mounted applications, never does 100% of the device's total power loss (heat) thermally conduct exclusively through the top or exclusively through bottom of the  $\mu$ Module package—as the standard defines for  $\theta_{JCtop}$  and  $\theta_{JCbottom}$ , respectively. In practice, power loss is thermally dissipated in both directions away from the package—granted, in the absence of a heat sink and airflow, a majority of the heat flow is into the board.

Within the LTM4637, be aware there are multiple power devices and components dissipating power, with a consequence that the thermal resistances relative to different junctions of components or die are not exactly linear with respect to total package power loss. To reconcile this complication without sacrificing modeling simplicity—but also not ignoring practical realities—an approach has been taken using FEA software modeling along with laboratory testing in a controlled-environment chamber to reasonably define and correlate the thermal resistance values supplied in this data sheet: (1) Initially, FEA software is used to accurately build the mechanical geometry of the LTM4637 and the specified PCB with all of the correct material coefficients along with accurate power loss source definitions; (2) this model simulates a software-defined JEDEC environment consistent with JESD51-12

to predict power loss heat flow and temperature readings at different interfaces that enable the calculation of the JEDEC-defined thermal resistance values; (3) the model and FEA software is used to evaluate the LTM4637 with heat sink and airflow; (4) having solved for and analyzed these thermal resistance values and simulated various operating conditions in the software model, a thorough laboratory evaluation replicates the simulated conditions with thermocouples within a controlled-environment chamber while operating the device at the same power loss as that which was simulated. The outcome of this process and due diligence yields the set of derating curves shown in this data sheet.

The 1V, 2.5V and 5V power loss curves in Figure 8 to Figure 10 can be used in coordination with the load current derating curves in Figure 11 to Figure 20 for calculating an approximate  $\theta_{JA}$  thermal resistance for the LTM4637 with various heat sinking and airflow conditions. The power loss curves are taken at room temperature and are increased with a multiplicative factor according to the junction temperature, which is 1.4 for 120°C. The derating curves are plotted with the output current starting at 20A and the ambient temperature at ~40°C. The output voltages are 1V, 2.5V and 5V. These are chosen to include the lower, middle and higher output voltage ranges for correlating the thermal resistance. Thermal models are derived from several temperature measurements in a controlled temperature chamber along with thermal modeling analysis. The junction temperatures are monitored while

## APPLICATIONS INFORMATION

ambient temperature is increased with and without airflow. The power loss increase with ambient temperature change is factored into the derating curves. The junctions are maintained at ~120°C maximum while lowering output current or power with increasing ambient temperature. The decreased output current will decrease the internal module loss as ambient temperature is increased. The monitored junction temperature of 120°C minus the ambient operating temperature specifies how much module temperature rise can be allowed. As an example, in Figure 13 the load current is derated to ~16A at ~80°C with no air or heat sink and the power loss for the 12V to 1.0V at 16A output is about 4W. The 4W loss is calculated with the ~2.8W room temperature loss from the 12V to 1.0V power loss curve at 16A, and the 1.4 multiplying factor at 120°C junction. If the 80°C ambient temperature is subtracted from the 120°C junction temperature, then

the difference of 40°C divided by 4W equals a 10°C/W  $\theta_{JA}$  thermal resistance. Table 2 specifies a 9.3°C/W value which is very close. Table 2 provides equivalent thermal resistances for 1.0V, 2.5V and 5V outputs with and without airflow and heat sinking. The derived thermal resistances in Table 2 thru Table 4 for the various conditions can be multiplied by the calculated power loss as a function of ambient temperature to derive temperature rise above ambient, thus maximum junction temperature. Room temperature power loss can be derived from the efficiency curves in the Typical Performance Characteristics section and adjusted with the above ambient temperature multiplicative factors. The printed circuit board is a 1.6mm thick four layer board with two ounce copper for the two outer layers and one ounce copper for the two inner layers. The PCB dimensions are 95mm × 76mm. The BGA heat sinks are listed in Table 6.

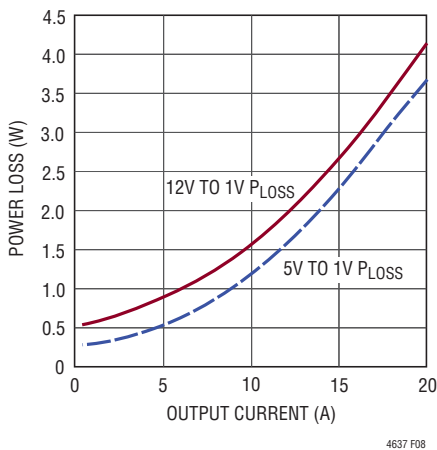

Figure 8. 1V<sub>OUT</sub> Power Loss

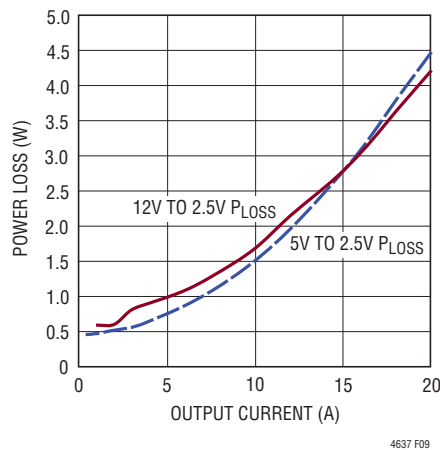

Figure 9. 2.5V<sub>OUT</sub> Power Loss

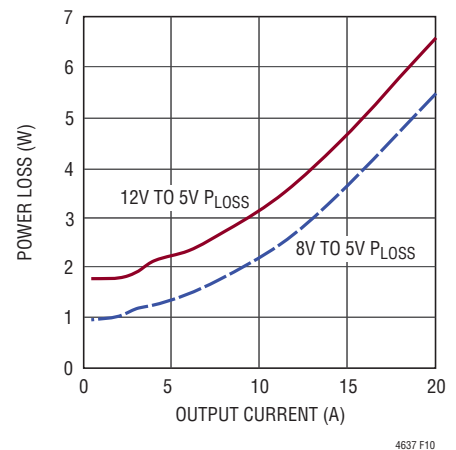

Figure 10. 5V<sub>OUT</sub> Power Loss

# APPLICATIONS INFORMATION

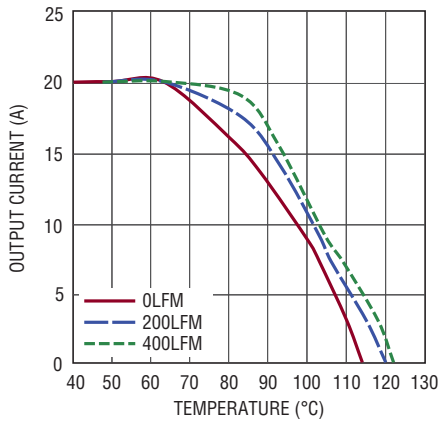

Figure 11. 5V<sub>IN</sub> to 1.0V<sub>OUT</sub> No Heat Sink

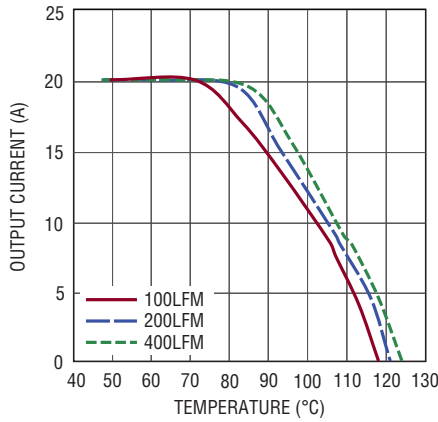

Figure 13. 5V<sub>IN</sub> to 1.0V<sub>OUT</sub> with Heat Sink

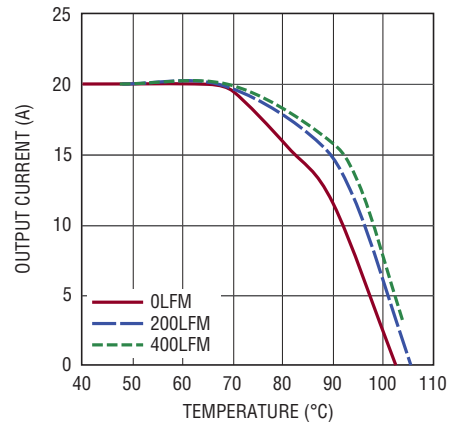

Figure 12. 12V<sub>IN</sub> to 1.0V<sub>OUT</sub> No Heat Sink

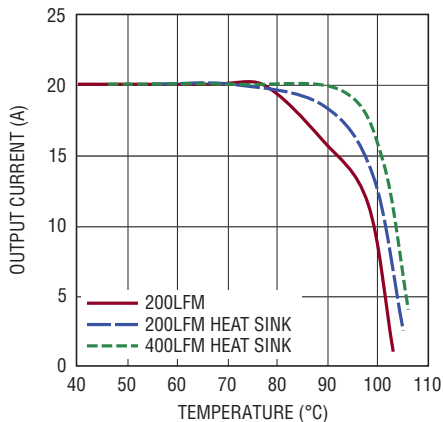

Figure 14. 12V<sub>IN</sub> to 1.0V<sub>OUT</sub> with Heat Sink

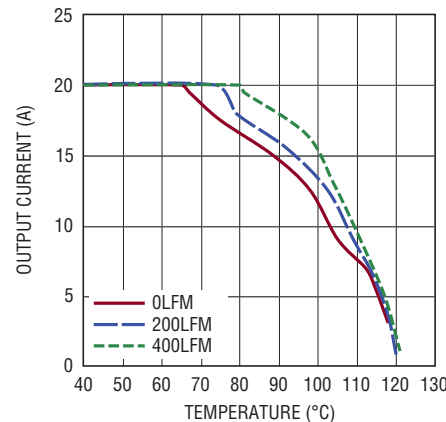

Figure 15. 5V<sub>IN</sub> to 2.5V<sub>OUT</sub> No Heat Sink

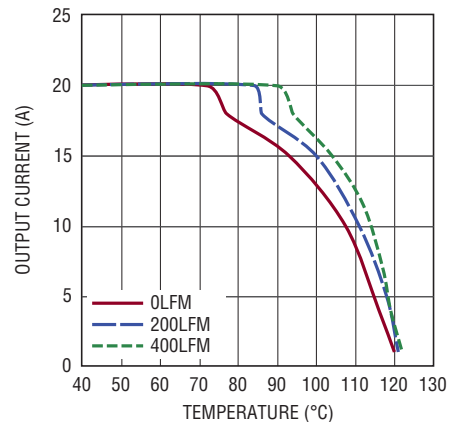

Figure 17. 5V<sub>IN</sub> to 2.5V<sub>OUT</sub> with Heat Sink

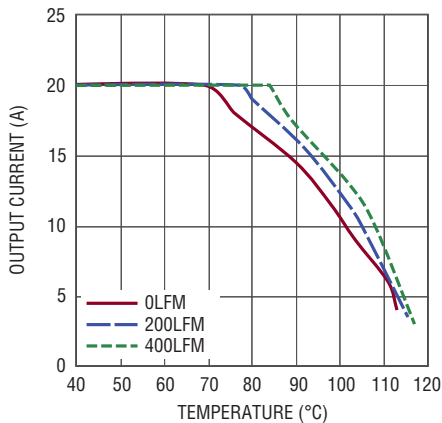

Figure 16. 12V<sub>IN</sub> to 2.5V<sub>OUT</sub> No Heat Sink

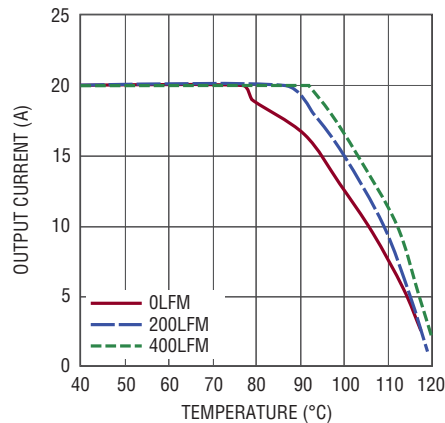

Figure 18. 12V<sub>IN</sub> to 2.5V<sub>OUT</sub> with Heat Sink

## APPLICATIONS INFORMATION

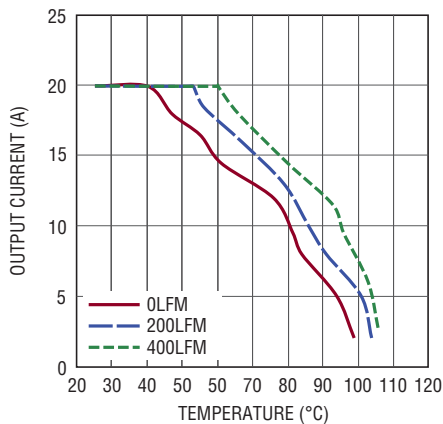

Figure 19. 12V<sub>IN</sub> to 5V<sub>OUT</sub> No Heat Sink, EXT<sub>VCC</sub> = 5V  
(Limit 5V Output to 15A)

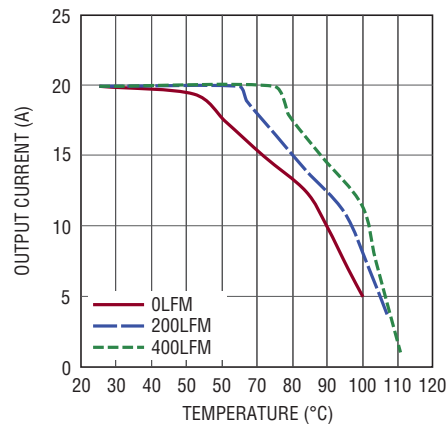

Figure 20. 12V<sub>IN</sub> to 5V<sub>OUT</sub> with Heat Sink, EXT<sub>VCC</sub> = 5V  
(Limit 5V Output to 15A)

Table 2. 1V Output

DERATING CURVE	V <sub>IN</sub>	POWER LOSS CURVE	AIRFLOW (LFM)	HEAT SINK	LGA θ <sub>JA</sub> (°C/W)	BGA θ <sub>JA</sub> (°C/W)
Figures 11, 13	5V, 12V	Figure 8	0	None	9.3	10.4
Figures 11, 13	5V, 12V	Figure 8	200	None	7.0	8.4
Figures 11, 13	5V, 12V	Figure 8	400	None	6.0	7.4
Figures 12, 14	5V, 12V	Figure 8	0	BGA Heat Sink	7.0	8.9
Figures 12, 14	5V, 12V	Figure 8	200	BGA Heat Sink	6.0	6.9
Figures 12, 14	5V, 12V	Figure 8	400	BGA Heat Sink	5.0	5.9

Table 3. 2.5V Output

DERATING CURVE	V <sub>IN</sub>	POWER LOSS CURVE	AIRFLOW (LFM)	HEAT SINK	LGA θ <sub>JA</sub> (°C/W)	BGA θ <sub>JA</sub> (°C/W)
Figures 15, 17	5V, 12V	Figure 9	0	None	9.5	10.4
Figures 15, 17	5V, 12V	Figure 9	200	None	8.0	8.4
Figures 15, 17	5V, 12V	Figure 9	400	None	7.0	7.4
Figures 16, 18	5V, 12V	Figure 9	0	BGA Heat Sink	8.0	8.9
Figures 16, 18	5V, 12V	Figure 9	200	BGA Heat Sink	6.5	6.9
Figures 16, 18	5V, 12V	Figure 9	400	BGA Heat Sink	5.5	5.9

Table 4. 5V Output (5V Output Connected to EXT<sub>VCC</sub> Pin)

DERATING CURVE	V <sub>IN</sub>	POWER LOSS CURVE	AIRFLOW (LFM)	HEAT SINK	LGA θ <sub>JA</sub> (°C/W)	BGA θ <sub>JA</sub> (°C/W)
Figure 19	12V	Figure 10	0	None	9.5	10.4
Figure 19	12V	Figure 10	200	None	8.0	8.9
Figure 19	12V	Figure 10	400	None	7.0	7.9
Figure 20	12V	Figure 10	0	BGA Heat Sink	8.0	8.9
Figure 20	12V	Figure 10	200	BGA Heat Sink	6.5	7.4
Figure 20	12V	Figure 10	400	BGA Heat Sink	5.5	6.4

## APPLICATIONS INFORMATION

Table 5. Output Voltage Response vs Component Matrix (Refer to Figure 22) 0A to 10A Load Step

C <sub>OUT1</sub> AND C <sub>OUT2</sub> CERAMIC VENDOR	VALUE	PART NUMBER	C <sub>OUT1</sub> AND C <sub>OUT2</sub> BULK VENDOR	VALUE	PART NUMBER	C <sub>IN</sub> VENDOR	VALUE	PART NUMBER
TDK	100μF 6.3V	C4532X5R0J107MZ	Sanyo POSCAP	1000μF 2.5V	2R5TPD1000M5	Sanyo	56μF 25V	25SVP56M
Murata	100μF 6.3V	GRM32ER60J107M	Sanyo POSCAP	470μF 2.5V	2R5TPD470M5	TDK	22μF 16V	C3216X651C226M
			Sanyo POSCAP	470μF 6.3V	6TPD470M5	Murata	22μF 16V	GRM31CR61C226KE15L

V <sub>OUT</sub> (V)	C <sub>IN</sub> (CERAMIC)	C <sub>IN</sub> (BULK) <sup>†</sup>	C <sub>OUT2</sub> (CERAMIC) AND C <sub>OUT1</sub> (BULK)	C <sub>FF</sub> (pF)	C <sub>COMP</sub> (pF)	V <sub>IN</sub> (V)	DROOP (mV)	PEAK-TO-PEAK DEVIATION (mV)	RECOVERY TIME (μs)	LOAD STEP (A/μs)	R <sub>FB</sub> (kΩ)	FREQ (kHz)
1	22μF × 4	56μF	100μF × 2, 470μF × 3	330	150	5,12	65	123	30	10	90.6	250
1.2	22μF × 4	56μF	100μF × 2, 470μF × 3	330	150	5,12	65	123	30	10	60.4	250
1.5	22μF × 4	56μF	100μF × 2, 470μF × 3	330	150	5,12	65	120	50	10	40.2	350
1.8	22μF × 4	56μF	100μF × 2, 470μF × 3	330	150	5,12	65	120	60	10	30.1	350
2.5	22μF × 4	56μF	100μF × 2, 470μF × 3	330	150	5,12	65	130	70	10	19.1	450
3.3	22μF × 4	56μF	100μF × 2, 470μF × 3	330	150	5,12	75	150	75	10	13.3	600
5	22μF × 4	56μF	100μF × 2, 470μF × 3	330	150	7,12	100	195	80	10	8.25	600
1	22μF × 4	56μF	100μF × 2, 470μF × 3	330	None	5,12	50	100	30	10	90.6	250
1.2	22μF × 4	56μF	100μF × 2, 470μF × 3	330	None	5,12	50	100	30	10	60.4	250
1.5	22μF × 4	56μF	100μF × 2, 470μF × 3	330	None	5,12	50	100	50	10	40.2	350
1.8	22μF × 4	56μF	100μF × 2, 470μF × 3	330	None	5,12	65	110	60	10	30.1	350
2.5	22μF × 4	56μF	100μF × 2, 470μF × 3	330	None	5,12	65	120	70	10	19.1	450
3.3	22μF × 4	56μF	100μF × 2, 470μF × 3	330	None	5,12	70	130	75	10	13.3	600
5	22μF × 4	56μF	100μF × 2, 470μF × 3	330	None	7,12	85	165	80	10	8.25	600
1	22μF × 4	56μF	100μF × 2, 470μF × 2	330	None	5,12	75	150	30	10	90.6	250
1.2	22μF × 4	56μF	100μF × 2, 470μF × 2	330	None	5,12	75	150	30	10	60.4	250
1.5	22μF × 4	56μF	100μF × 2, 470μF × 2	330	None	5,12	70	140	50	10	40.2	350
1.8	22μF × 4	56μF	100μF × 2, 470μF × 2	330	None	5,12	65	130	60	10	30.1	350
2.5	22μF × 4	56μF	100μF × 2, 470μF × 2	330	None	5,12	65	130	70	10	19.1	450
3.3	22μF × 4	56μF	100μF × 2, 470μF × 2	330	None	5,12	70	140	75	10	13.3	600
5	22μF × 4	56μF	100μF × 2, 470μF × 2	330	None	7,12	100	190	80	10	8.25	600
1	22μF × 4	56μF	100μF × 4, 470μF × 1	47	None	5,12	95	190	30	10	90.6	250
1.2	22μF × 4	56μF	100μF × 4, 470μF × 1	47	None	5,12	95	190	30	10	60.4	250
1.5	22μF × 4	56μF	100μF × 4, 470μF × 1	47	None	5,12	90	180	50	10	40.2	350
1.8	22μF × 4	56μF	100μF × 4, 470μF × 1	47	None	5,12	95	190	60	10	30.1	350
2.5	22μF × 4	56μF	100μF × 4, 470μF × 1	47	None	5,12	100	200	70	10	19.1	450
3.3	22μF × 4	56μF	100μF × 4, 470μF × 1	47	None	5,12	125	250	75	10	13.3	600
5	22μF × 4	56μF	100μF × 4, 470μF × 1	47	None	7,12	155	310	80	10	8.25	600
1	22μF × 4	56μF	100μF × 5	47	None	5,12	100	200	35	10	90.6	250
1.2	22μF × 4	56μF	100μF × 5	47	None	5,12	100	200	35	10	60.4	250
1.5	22μF × 4	56μF	100μF × 5	47	None	5,12	100	200	35	10	40.2	350
1.8	22μF × 4	56μF	100μF × 5	47	None	5,12	112	225	35	10	30.1	350
2.5	22μF × 4	56μF	100μF × 5	47	None	5,12	125	250	40	10	19.1	450
3.3	22μF × 4	56μF	100μF × 5	47	None	5,12	170	340	40	10	13.3	600
5	22μF × 4	56μF	100μF × 5	47	None	7,12	225	450	60	10	8.25	600

<sup>†</sup>Bulk capacitance is optional if V<sub>IN</sub> has very low input impedance.

## APPLICATIONS INFORMATION

**Table 6. Recommended Heat Sinks**

HEAT SINK MANUFACTURER	PART NUMBER	WEBSITE
AAVID Thermalloy	375424B00034G	www.aavidthermalloy.com
Cool Innovations	4-050503P to 4-050508P	www.coolinnovations.com

### Safety Considerations

The LTM4637 does not provide galvanic isolation from  $V_{IN}$  to  $V_{OUT}$ . There is no internal fuse. If required, a slow blow fuse with a rating twice the maximum input current needs to be provided to protect each unit from catastrophic failure.

The fuse or circuit breaker should be selected to limit the current to the regulator during overvoltage in case of an internal top MOSFET fault. If the internal top MOSFET fails, then turning it off will not resolve the overvoltage, thus the internal bottom MOSFET will turn on indefinitely trying to protect the load. Under this fault condition, the input voltage will source very large currents to ground through the failed internal top MOSFET and enabled internal bottom MOSFET. This can cause excessive heat and board damage depending on how much power the input voltage can deliver to this system. A fuse or circuit breaker can be used as a secondary fault protector in this situation. The LTM4637 does support overvoltage protection, overcurrent protection and overtemperature protection.

### Layout Checklist/Example

The high integration of the LTM4637 makes the PCB board layout very simple and easy. However, to optimize

its electrical and thermal performance, some layout considerations are still necessary.

- Use large PCB copper areas for high current paths, including  $V_{IN}$ , GND and  $V_{OUT}$ . It helps to minimize the PCB conduction loss and thermal stress.
- Place high frequency ceramic input and output capacitors next to the  $V_{IN}$ , GND and  $V_{OUT}$  pins to minimize high frequency noise.
- Place a dedicated power ground layer underneath the unit.
- To minimize the via conduction loss and reduce module thermal stress, use multiple vias for interconnection between top layer and other power layers.
- Do not put vias directly on the pad, unless they are capped or plated over.
- Place test points on signal pins for testing.
- Use a separated SGND ground copper area for components connected to signal pins. Connect the SGND to GND underneath the unit.
- For parallel modules, tie the COMP and  $V_{FB}$  pins together. Use an internal layer to closely connect these pins together.

Figure 21 gives a good example of the recommended layout.

## APPLICATIONS INFORMATION

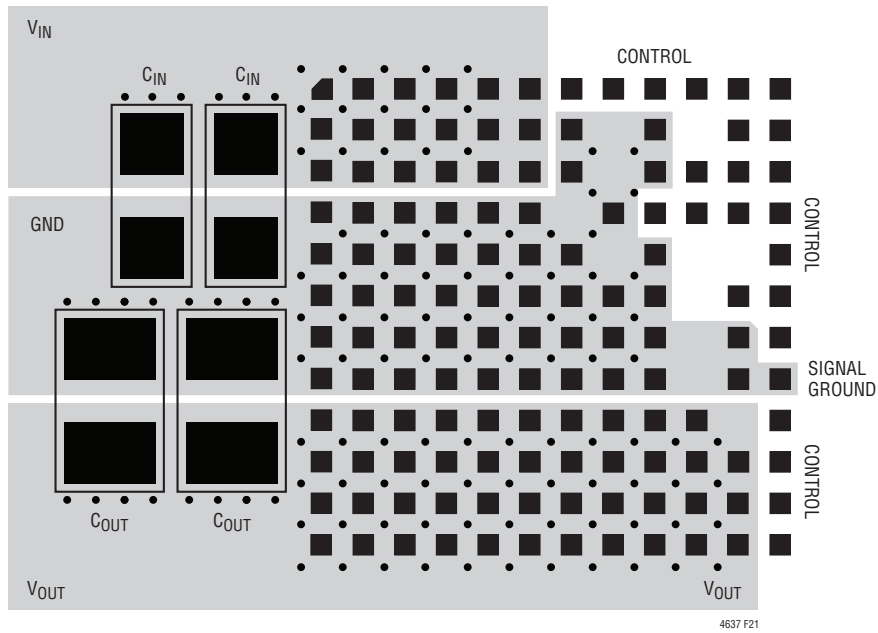

Figure 21. Recommended PCB Layout (LGA Shown, for BGA Use Circle Pads)

## TYPICAL APPLICATIONS

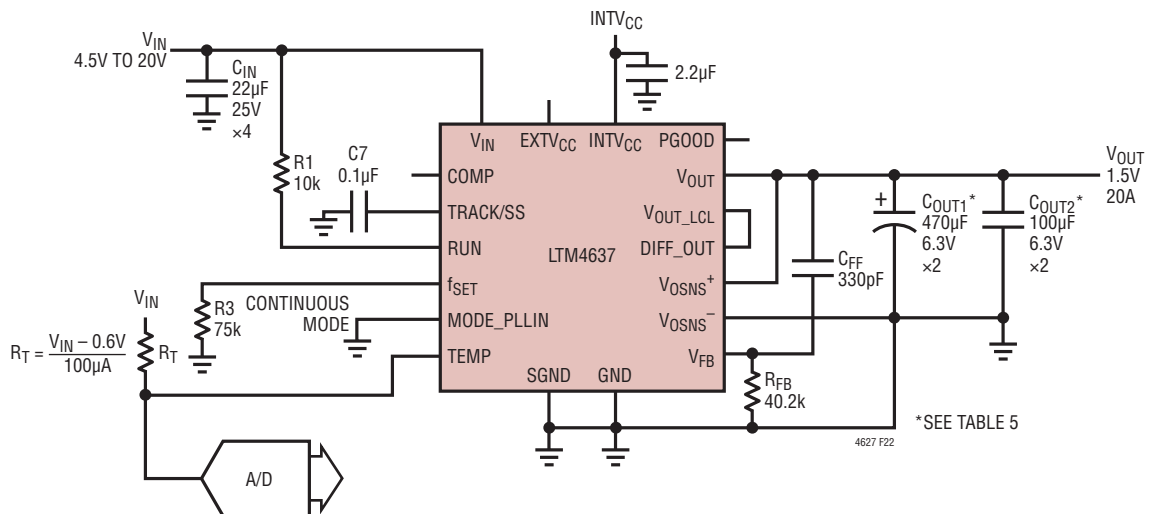

Figure 22. 4.5V to 20V<sub>IN</sub>, 1.5V at 20A Design

TYPICAL APPLICATIONS

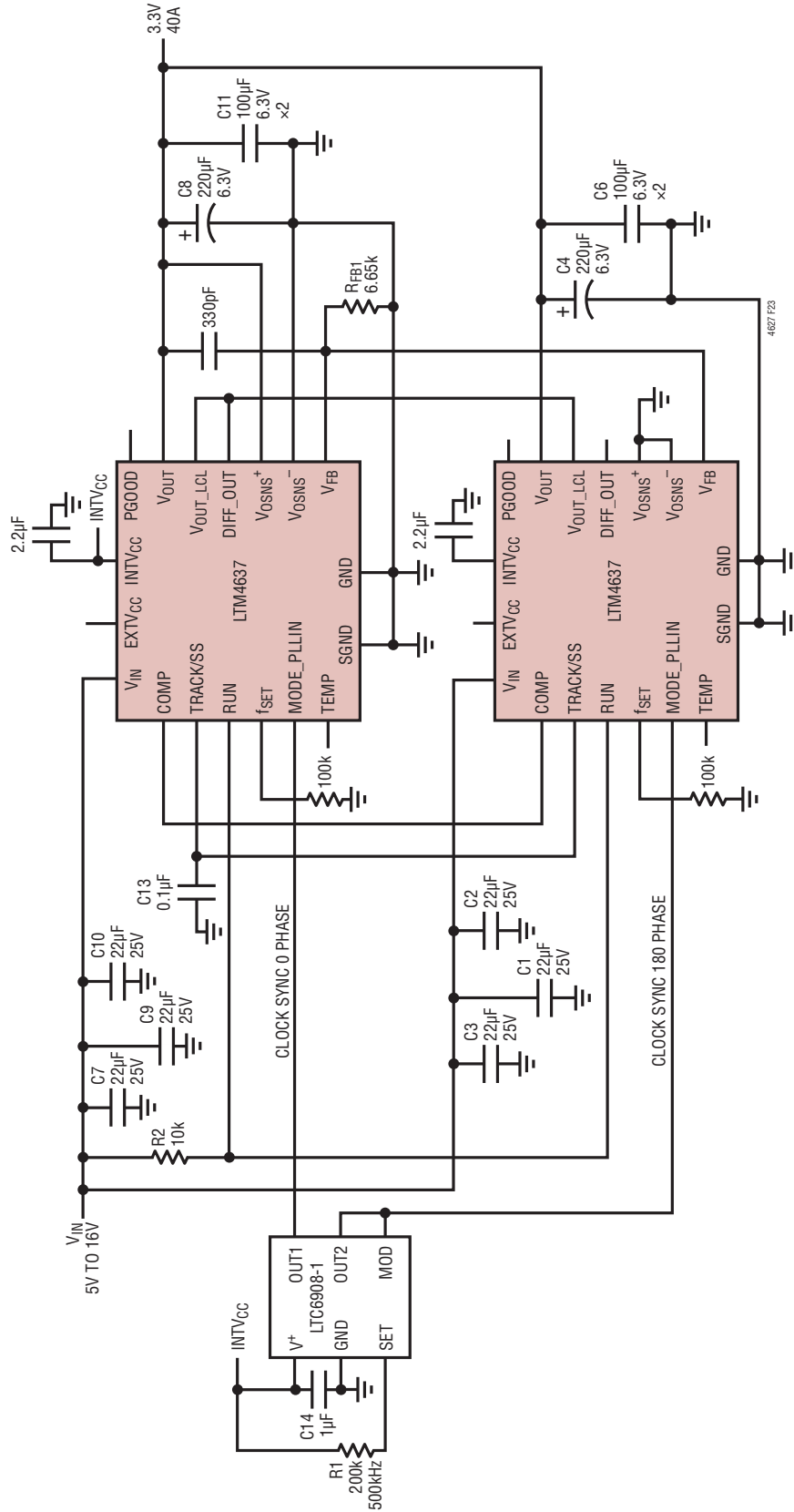

Figure 23. 3.3V at 40A, Two Parallel Outputs with 2-Phase Operation

TYPICAL APPLICATIONS

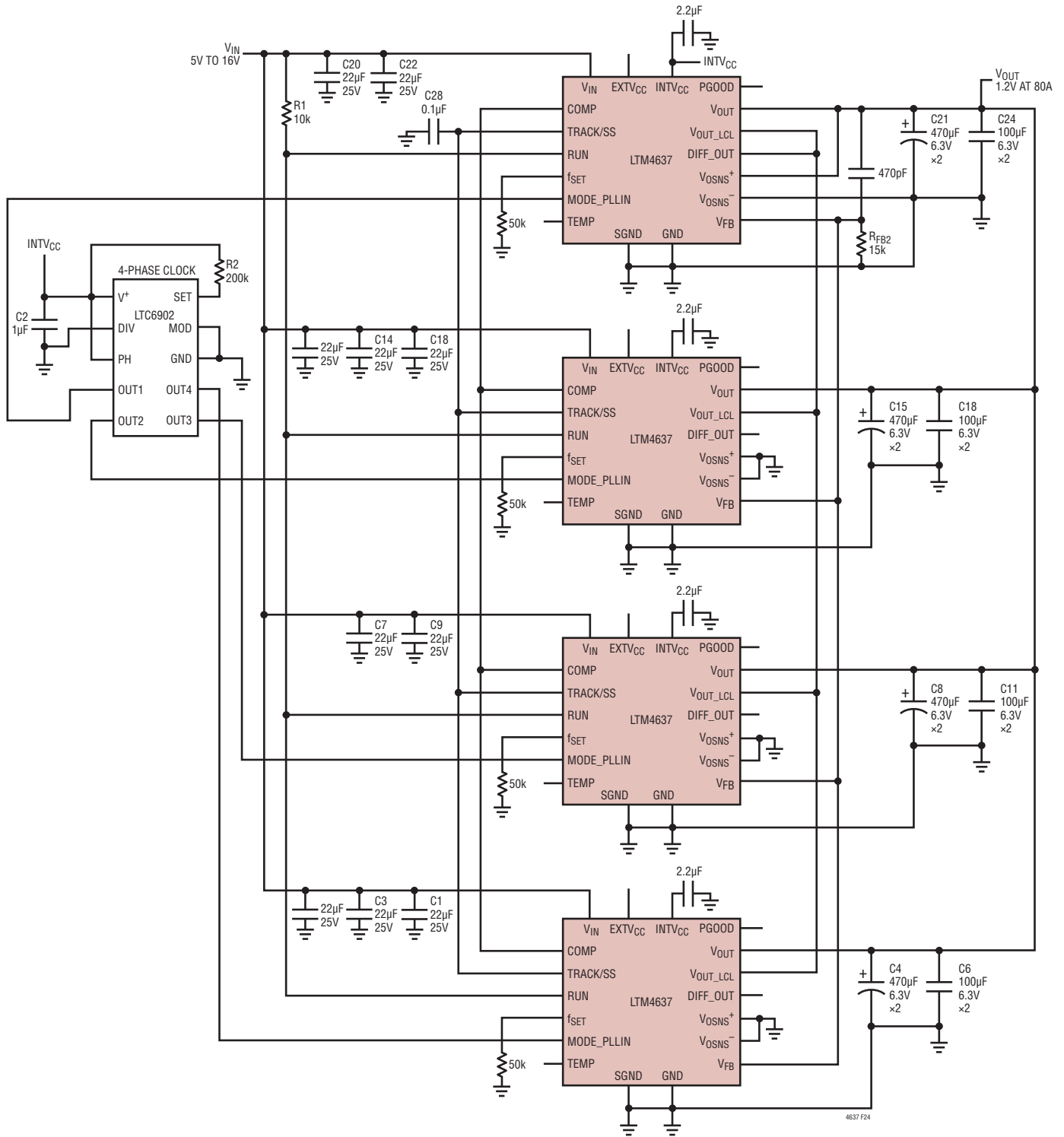

Figure 24. 1.2V, 80A, Current Sharing with 4-Phase Operation

## PACKAGE DESCRIPTION



PACKAGE ROW AND COLUMN LABELING MAY VARY AMONG  $\mu$ Module PRODUCTS. REVIEW EACH PACKAGE LAYOUT CAREFULLY.

Pin Assignment Table (Arranged by Pin Number)

PIN ID	FUNCTION	PIN ID	FUNCTION	PIN ID	FUNCTION	PIN ID	FUNCTION	PIN ID	FUNCTION	PIN ID	FUNCTION
A1	V <sub>IN</sub>	B1	V <sub>IN</sub>	C1	V <sub>IN</sub>	D1	GND	E1	GND	F1	GND
A2	V <sub>IN</sub>	B2	V <sub>IN</sub>	C2	V <sub>IN</sub>	D2	GND	E2	GND	F2	GND
A3	V <sub>IN</sub>	B3	V <sub>IN</sub>	C3	V <sub>IN</sub>	D3	GND	E3	GND	F3	GND
A4	V <sub>IN</sub>	B4	V <sub>IN</sub>	C4	V <sub>IN</sub>	D4	GND	E4	GND	F4	GND
A5	V <sub>IN</sub>	B5	V <sub>IN</sub>	C5	V <sub>IN</sub>	D5	GND	E5	GND	F5	GND
A6	V <sub>IN</sub>	B6	V <sub>IN</sub>	C6	V <sub>IN</sub>	D6	GND	E6	GND	F6	GND
A7	INTV <sub>CC</sub>	B7	GND	C7	GND	D7	–	E7	GND	F7	GND
A8	MODE_PLLIN	B8	–	C8	–	D8	GND	E8	–	F8	GND
A9	TRACK/SS	B9	GND	C9	GND	D9	INTV <sub>CC</sub>	E9	GND	F9	GND
A10	RUN	B10	–	C10	MTP3	D10	TEMP	E10	–	F10	–
A11	COMP	B11	MTP2	C11	MTP4	D11	MTP6	E11	–	F11	PGOOD
A12	MTP1	B12	f <sub>SET</sub>	C12	MTP5	D12	MTP7	E12	EXTV <sub>CC</sub>	F12	V <sub>FB</sub>

PIN ID	FUNCTION	PIN ID	FUNCTION	PIN ID	FUNCTION	PIN ID	FUNCTION	PIN ID	FUNCTION	PIN ID	FUNCTION
G1	GND	H1	GND	J1	V <sub>OUT</sub>	K1	V <sub>OUT</sub>	L1	V <sub>OUT</sub>	M1	V <sub>OUT</sub>
G2	GND	H2	GND	J2	V <sub>OUT</sub>	K2	V <sub>OUT</sub>	L2	V <sub>OUT</sub>	M2	V <sub>OUT</sub>
G3	GND	H3	GND	J3	V <sub>OUT</sub>	K3	V <sub>OUT</sub>	L3	V <sub>OUT</sub>	M3	V <sub>OUT</sub>
G4	GND	H4	GND	J4	V <sub>OUT</sub>	K4	V <sub>OUT</sub>	L4	V <sub>OUT</sub>	M4	V <sub>OUT</sub>
G5	GND	H5	GND	J5	V <sub>OUT</sub>	K5	V <sub>OUT</sub>	L5	V <sub>OUT</sub>	M5	V <sub>OUT</sub>
G6	GND	H6	GND	J6	V <sub>OUT</sub>	K6	V <sub>OUT</sub>	L6	V <sub>OUT</sub>	M6	V <sub>OUT</sub>
G7	GND	H7	GND	J7	V <sub>OUT</sub>	K7	V <sub>OUT</sub>	L7	V <sub>OUT</sub>	M7	V <sub>OUT</sub>
G8	GND	H8	GND	J8	V <sub>OUT</sub>	K8	V <sub>OUT</sub>	L8	V <sub>OUT</sub>	M8	V <sub>OUT</sub>
G9	GND	H9	GND	J9	V <sub>OUT</sub>	K9	V <sub>OUT</sub>	L9	V <sub>OUT</sub>	M9	V <sub>OUT</sub>
G10	–	H10	–	J10	V <sub>OUT</sub>	K10	V <sub>OUT</sub>	L10	V <sub>OUT</sub>	M10	V <sub>OUT</sub>
G11	SGND	H11	SGND	J11	–	K11	V <sub>OUT</sub>	L11	V <sub>OUT</sub>	M11	V <sub>OUT</sub>
G12	PGOOD	H12	SGND	J12	V <sub>OSNS+</sub>	K12	DIFF_OUT	L12	V <sub>OUT_LCL</sub>	M12	V <sub>OSNS-</sub>

## PACKAGE PHOTOS Part marking is either ink mark or laser mark

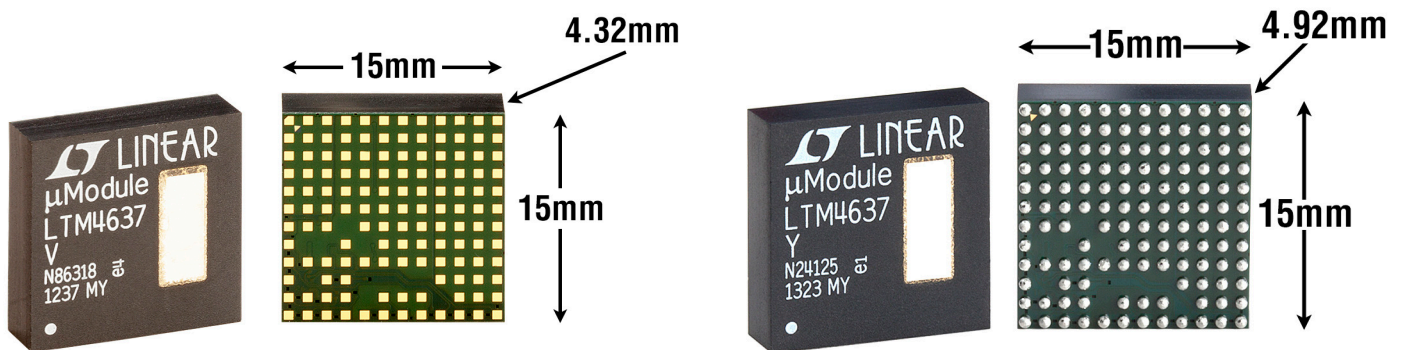

# PACKAGE DESCRIPTION



## LGA Package 133-Lead (15mm x 15mm x 4.32mm) (Reference DWG # 05-08-1906)

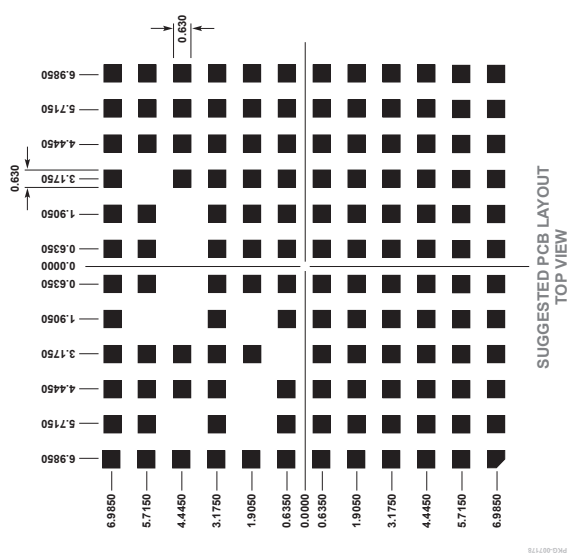
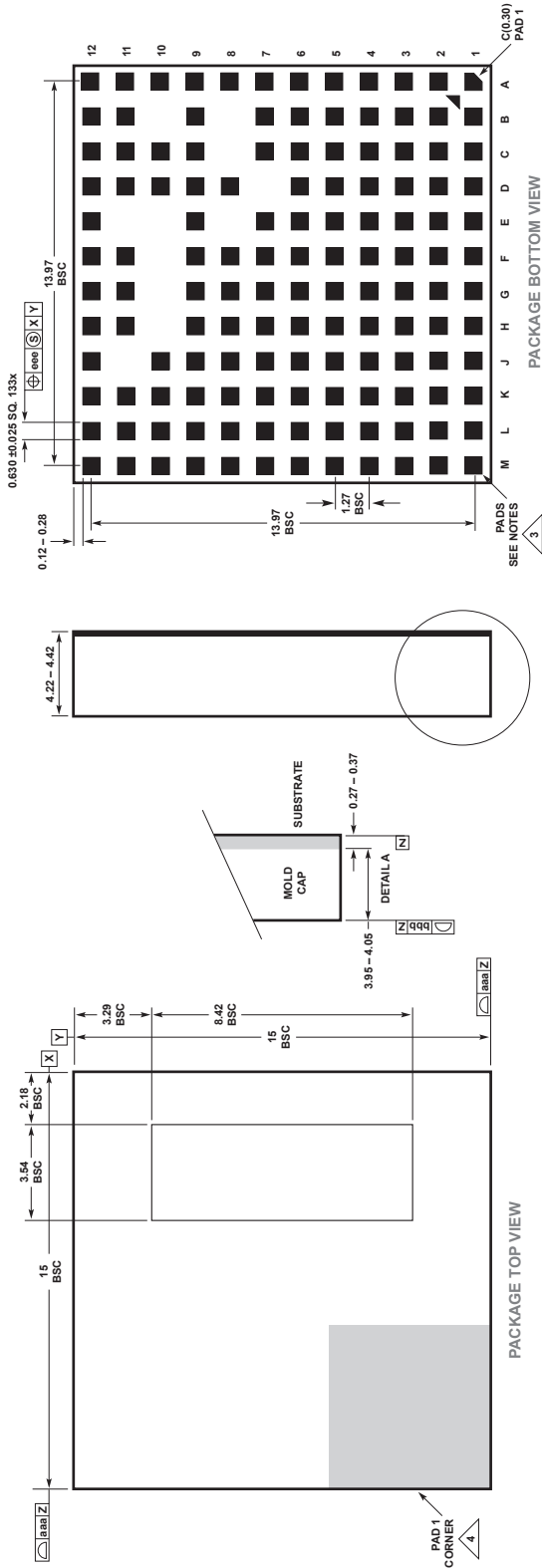

- NOTES:**
1. DIMENSIONING AND TOLERANCING PER ASME Y14.5M-1994
  2. ALL DIMENSIONS ARE IN MILLIMETERS
  3. LAND DESIGNATION PER JEDEC MO-222, SPP-010
  4. DETAILS OF PAD #1 IDENTIFIER ARE OPTIONAL BUT MUST BE LOCATED WITHIN THE ZONE INDICATED. THE PAD #1 IDENTIFIER MAY BE EITHER A MOLD OR MARKED FEATURE
  5. PRIMARY DATUM -Z- IS SEATING PLANE
  6. THE TOTAL NUMBER OF PADS: 133

SYMBOL TOLERANCE	
aaa	0.15
bbb	0.10
eee	0.05

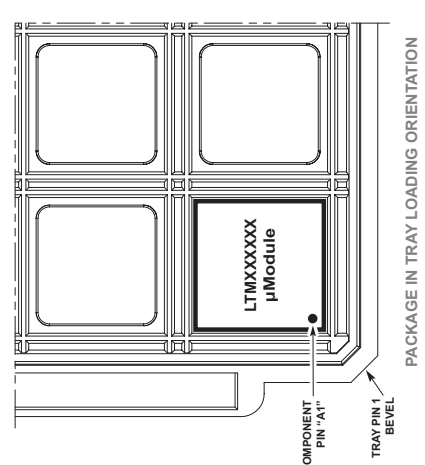

15-22-2023-A

FIG. 02713

PACKAGE DESCRIPTION

**BGA Package**  
**133-Lead (15mm × 15mm × 4.92mm)**  
 (Reference LTC DWG # 05-08-1940 Rev A)

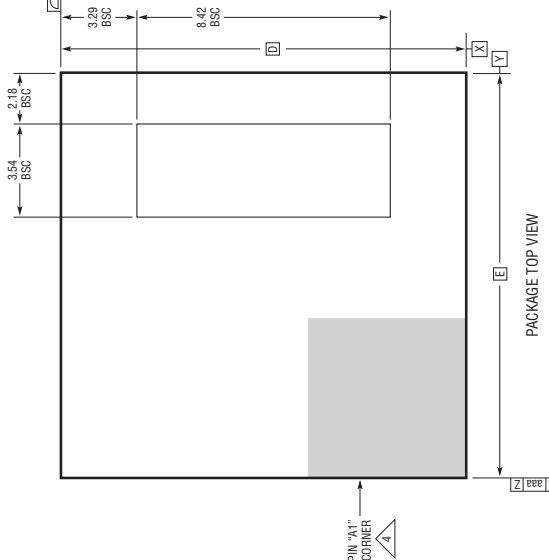
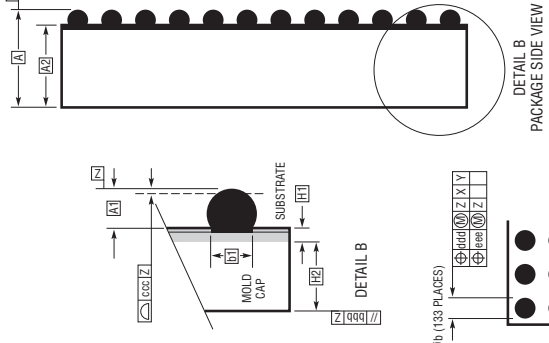
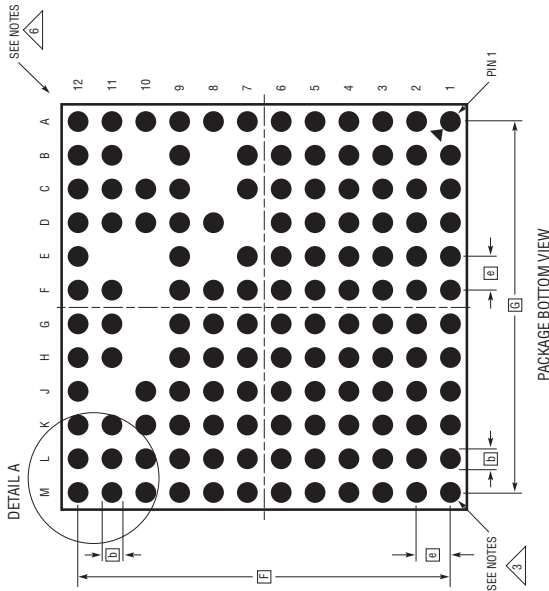

- NOTES:
1. DIMENSIONING AND TOLERANCING PER ASME Y14.5M-1994
  2. ALL DIMENSIONS ARE IN MILLIMETERS
  3. BALL DESIGNATION PER JEDEC MS-028 AND JEP95
  4. DETAILS OF PIN #1 IDENTIFIER ARE OPTIONAL, BUT MUST BE LOCATED WITHIN THE ZONE INDICATED. THE PIN #1 IDENTIFIER MAY BE EITHER A MOLD OR MARKED FEATURE
  5. PRIMARY DATUM -Z- IS SEATING PLANE
  6. PACKAGE ROW AND COLUMN LABELING MAY VARY AMONG μModule PRODUCTS. REVIEW EACH PACKAGE LAYOUT CAREFULLY

SYMBOL	DIMENSIONS		NOTES
	MIN	NOM	
A	4.72	4.92	5.12
A1	0.50	0.60	0.70
A2	4.22	4.32	4.42
b	0.60	0.75	0.90
b1	0.60	0.63	0.66
D	15.0		
E	15.0		
e	1.27		
F	13.97		
G	13.97		
H1	0.27	0.32	0.37
H2	3.95	4.00	4.05
aaa	0.15		
bbb	0.10		
ccc	0.20		
ddd	0.30		
eee	0.15		
TOTAL NUMBER OF BALLS: 133			

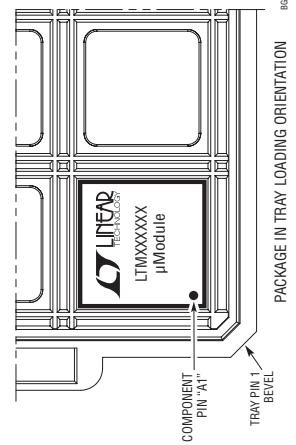
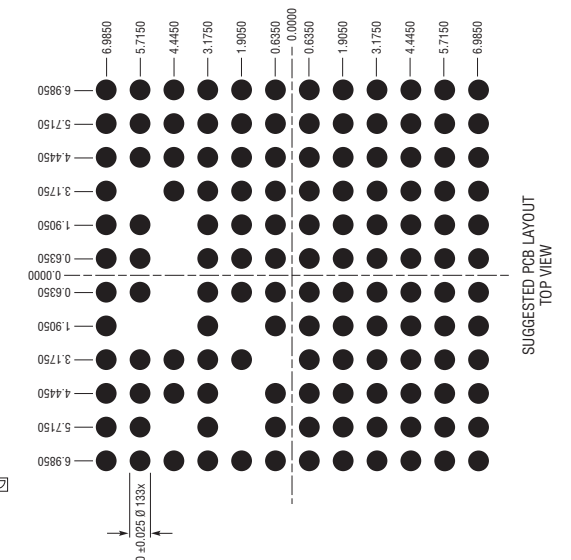

BGA 133 0517 REV A

## REVISION HISTORY

REV	DATE	DESCRIPTION	PAGE NUMBER
A	07/13	Added instruction to TEMP pin usage. Updated all graphs.	9 19, 20
B	10/13	Added BGA package.	1, 2, 28
C	02/14	Added SnPb BGA package option.	1, 2
D	02/24	Changed lead to pin in the Pin Configuration drawing. Reorganized Pin Functions alphanumerically. Updated Power Module Description Added ink marking statement to package photos. Updated LTM4637 LGA package photo. Changed master to main and slave to subordinate.	2 7, 8 9 26 26 All

## TYPICAL APPLICATION

### 1.8V at 20A Design

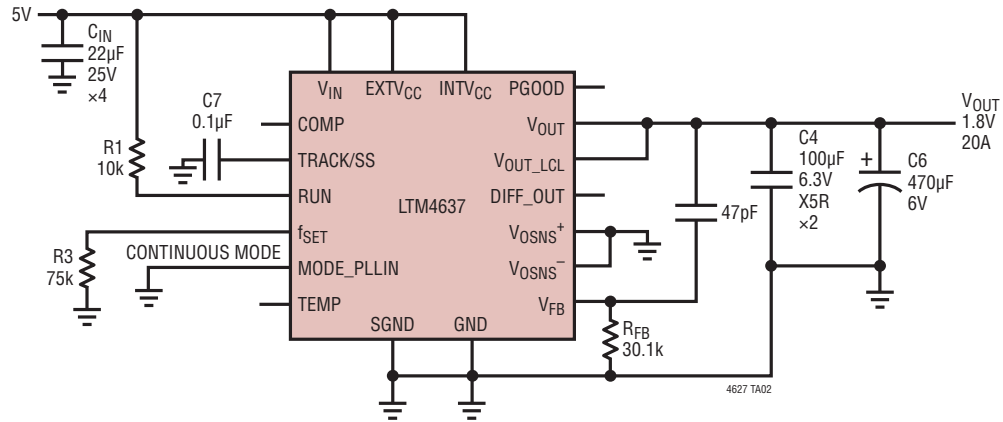

## DESIGN RESOURCES

SUBJECT	DESCRIPTION
<a href="#">µModule Design and Manufacturing Resources</a>	<p>Design:</p> <ul style="list-style-type: none"> <li>• Selector Guides</li> <li>• Demo Boards and Gerber Files</li> <li>• Free Simulation Tools</li> </ul> <p>Manufacturing:</p> <ul style="list-style-type: none"> <li>• Quick Start Guide</li> <li>• PCB Design, Assembly and Manufacturing Guidelines</li> <li>• Package and Board Level Reliability</li> </ul>
<a href="#">µModule Regulator Products Search</a>	<ol style="list-style-type: none"> <li>1. Sort table of products by parameters and download the result as a spread sheet.</li> <li>2. Search using the Quick Power Search parametric table.</li> </ol> <div style="border: 1px solid #ccc; padding: 5px; margin-top: 10px;"> <p><b>Quick Power Search</b></p> <p>INPUT   <math>V_{in}(\text{Min})</math> <input type="text"/> V <math>V_{in}(\text{Max})</math> <input type="text"/> V</p> <p>OUTPUT   <math>V_{out}</math> <input type="text"/> V <math>I_{out}</math> <input type="text"/> A</p> <p>FEATURES   <input type="checkbox"/> Low EMI <input type="checkbox"/> Ultrathin <input type="checkbox"/> Internal Heat Sink</p> <p style="text-align: right;"><input type="button" value="Multiple Outputs"/> <input type="button" value="Search"/></p> </div>
<a href="#">Digital Power System Management</a>	<p>Analog Devices' family of digital power supply management ICs are highly integrated solutions that offer essential functions, including power supply monitoring, supervision, margining and sequencing, and feature EEPROM for storing user configurations and fault logging.</p>

## RELATED PARTS

PART NUMBER	DESCRIPTION	COMMENTS
<a href="#">LTM4609</a>	Buck-Boost DC/DC µModule Family	All Pin Compatible; Up to 5A; Up to 36V <sub>IN</sub> , 34V <sub>OUT</sub> 15mm × 15mm × 2.82mm
<a href="#">LTM4612</a>	Ultralow Noise High V <sub>OUT</sub> DC/DC µModule Regulator	5A, 5V ≤ V <sub>IN</sub> ≤ 36V, 3.3V ≤ V <sub>OUT</sub> ≤ 15V, 15mm × 15mm × 2.82mm Package
<a href="#">LTM4627</a>	15A DC/DC µModule Regulator	4.5V ≤ V <sub>IN</sub> ≤ 20V, 0.6V ≤ V <sub>OUT</sub> ≤ 5V, LGA and BGA Packages
<a href="#">LTM4620</a>	Dual 13A, Single 26A DC/DC µModule Regulator	Up to 100A with Four in Parallel, 4.5V ≤ V <sub>IN</sub> ≤ 16V, 0.6V ≤ V <sub>OUT</sub> ≤ 2.5V

## Looking for pricing, stock, or lifecycle information?

Click below to explore more details on WIN SOURCE:

 [View LTM4637IY#PBF on WIN SOURCE](#)

 [Analog Devices Inc. Information](#)

## Optimize Your Supply Chain with WIN SOURCE Solutions

-  Global Sourcing Solution
-  Obsolete Management
-  Cost Control Management
-  Shortage Management
-  Alternative Solution
-  Excess Inventory Management