



**THE DATASHEET OF**  
**914CE1-3A**



# 914CE SERIES

002381  
Issue 10

## MICRO SWITCH Miniature Precision Limit Switches



### DESCRIPTION

All MICRO SWITCH 914CE Series miniature precision switches incorporate fluorocarbon diaphragm sealing to provide reliable protection, meeting NEMA 1, 2, 3, 3R, 4, 6, 6P, and 13, as well as IP66, IP67, and IP68 requirements. Versions with a boot seal also meet NEMA 12 requirements (dust, falling dirt, liquid media with solid contaminants). The cable or connector and basic switch terminals are encapsulated in an epoxy sealant, offering excellent resistance in harsh environments. For low temperature applications (down to -40 °C, -40 °F), CE Series switches can be supplied with low temperature seals and lubricant.

The CE Series switches are rugged and versatile switches which can be applied indoors in many harsh factory floor applications, as well as on outdoor equipment in extreme temperatures. A full range of actuators are available, including pin plungers, roller plungers, side rotary, multi-directional wire, and manually operated. The switches are also available with the industry standard, M12 micro-change 4-pin connector. MICRO SWITCH 914CE products meet North American, cURus standards, as well as European CE and United Kingdom UKCA requirements.

### FEATURES

- Rugged, miniature construction means minimal real estate on equipment
- NEMA 1, 2, 3, 3R, 4, 6, 6P, 12 (boot seal), 13, and IP66/67/68 environmental sealing
- Pre-leaded (UL cable) or supplied with a M12 four-pin connector
- Wide selection of actuators and cable length variations with side and bottom exit cable/connector options
- 25 mm mounting centers engineered with a MICRO SWITCH SM switch for consistent, precise actuation
- Well suited for up to 10 million actuation cycles (Up to 5 million actuation cycles for wobble actuators)
- Gang mounting capability to provide a multi-plunger limit switch
- Low temperature variants available for indoor and outdoor applications
- cURus, CE approvals for world-wide use
- UKCA approval for United Kingdom use

### POTENTIAL APPLICATIONS

- Machine tools
- Off-road equipment
- Material handling
- Dock locks and dock levelers
- Access and mobility solutions
- Textile machinery
- Robotics
- Packaging equipment
- Commercial appliances
- Print trade machinery
- Agricultural machinery

### VALUE TO CUSTOMERS

- Big performance in a small package
- Delivers consistent performance in many demanding environments where petroleum, synthetic, or water based fluids are present
- Product variation within defined nomenclature

### DIFFERENTIATION

- Diaphragm seal between the actuator and the switch cavity for high performance sealing
- CE Series incorporates a MICRO SWITCH SM basic switch for consistent, precise actuation
- Side exit termination for space constraints

### PORTFOLIO



The 914CE Series is part of the 14CE, NGC, SZL-VL-S, SSCE and SL1 Series of miniature limit switches. Honeywell also offers a portfolio of MICRO SWITCH Heavy-Duty Limit Switches and General Purpose Limit Switches.

**Honeywell**

# MICRO SWITCH MINIATURE PRECISION LIMIT SWITCHES, 914CE SERIES

**TABLE 1. SPECIFICATIONS**

Characteristic	Parameter
Description	compact enclosed limit switch
Actuators	<ul style="list-style-type: none"> <li>• Top pin plunger (914CE1-)</li> <li>• Cross roller plunger (914CE3-)</li> <li>• Top pin plunger with boot seal (914CE18-)</li> <li>• Wobble (914CE20-)</li> <li>• Top pin plunger, panel mount (914CE27-)</li> <li>• Top roller plunger, parallel and panel mount (914CE28-)</li> <li>• Top roller plunger, perpendicular, panel mount (914CE29-)</li> <li>• Top roller plunger, parallel &amp; boot sealed (914CE31-)</li> <li>• Top roller plunger, perpendicular, boot seal (914CE55-)</li> <li>• Parallel roller plunger (914CE2-)</li> <li>• Side rotary (914CE16-)</li> <li>• Top adjustable plunger (914CE19-)</li> <li>• Manually operated (914CE22-)</li> <li>• Ball bearing plunger (914CE66-)</li> </ul>
Terminations	SJTO 4 x 0,75 mm <sup>2</sup> (18 AWG) cable Connector (dc), 4-pin male, M12 thread (-Q), (-Q2) Revised pin-out, see page 3 Connector (ac), 4-pin male, 1/2 in x 20 thread (-Q1)
Switching options	SPDT, snap action contacts (1NC/1NO), Form C
Sealing	IP66, IP67, IP68*; NEMA 1, 2, 3, 3R, 4, 6, 6P, 12 (boot seal), 13
Operating temperature	0 °C to 105 °C [32 °F to 221 °F]; optional -40 °C to 105 °C [-40 °F to 221 °F] Side rotary: -40° C to 100 °C [-40 °F to 212 °F]
Mechanical life	up to 10 million (up to 5 million for wobbles) cycles
Thermal current	1 A
Rated insulation voltage (Ui)	250 V
Rated impulse withstand voltage (Uimp)	1.5 kV
Short circuit protection device (SCPD)	Quick blow fuse suitable for rated current of switch
Pollution degree	3
Min. actuation speed	0.003 m/s
Max. actuation speed	0.1 m/s
Max. actuation frequency	ac – 200 Hz; dc – 20 Hz
Shock	50 g – IEC 60068-2-27
Vibration	10 g – IEC 60068-2-6
Approvals	cURus, CE, UKCA
Conforming to standards	EN 60947-5-1; AC-14 D300, DC-13 R300 UL recognized to US and Canadian Requirements

\*IP68 sealing submerged in one meter of water for 24 hours

**TABLE 2. ELECTRICAL RATINGS (IN AMPERES)**

Model example	Contacts	Rating
914CE* - *	Silver contacts	A
914CE* - *G	Gold contacts	B
914CE* -Q, -AQ, -AQ1, -Q2	Silver contacts	C with 4-pin connector

Rating code		Make	Break
A	240 Vac, ind.	1.2	0.2
	240 Vac, res.	5	5
	28 Vdc, res.	3	3
	28 Vdc, ind.	3	3
	5 A, 1/10 HP, 125 Vac or 250 Vac	–	–
B	5-25 mA	–	–
	5-50 Vdc	–	–
C	3 A, 125 Vac or 250 Vac	–	–

# MICRO SWITCH MINIATURE PRECISION LIMIT SWITCHES, 914CE SERIES

## SWITCHING AND LEAD IDENTIFICATION

### 914CE

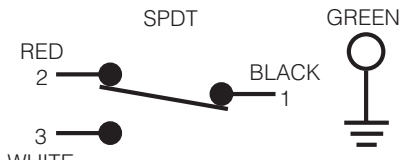

## PINOUTS

Connector - (dc) (-Q)	Connector (dc) (-Q2)	Connector (ac) (-Q1)

## CONNECTOR VERSIONS

The 914CE Series is available with a 4-pin, M12 size connector in both bottom and side exit versions.

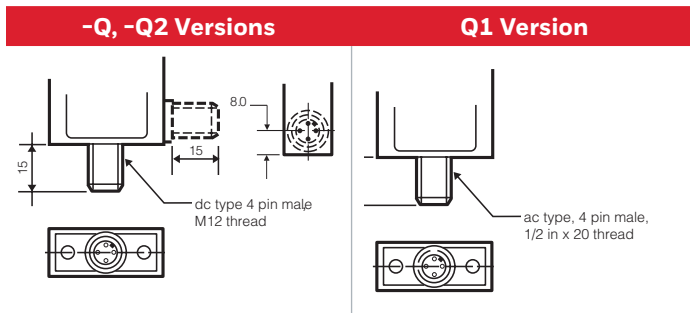

## MOUNTING

MICRO SWITCH 914CE Series switches are mounted by using two M5 or #10 screws. The mounting holes are counter bored to keep the screw heads within the overall switch housing dimensions.

## GANG MOUNT CAPABILITY

The housing on the 914CE Series has been designed to enable the user to build his own multiple plunger switch by gang mounting several switches. All pin plunger and roller plunger types are suitable for gang mounting. There is a 16 mm distance between the plungers. Both Series types are very versatile that even a lever-type version could be added at the end of the row.

## BOTTOM EXIT OR SIDE EXIT ORIENTATION

The CE Series has been designed with a pre-wired cable fitted in the bottom of the switch housing. Other variations are available with a side exit cable.

## GOLD CONTACT VERSIONS

For low energy applications, gold contact versions of the 914CE switches can be supplied upon request.

# MICRO SWITCH MINIATURE PRECISION LIMIT SWITCHES, 914CE SERIES

## GENERAL DIMENSIONS • ALL SWITCHES

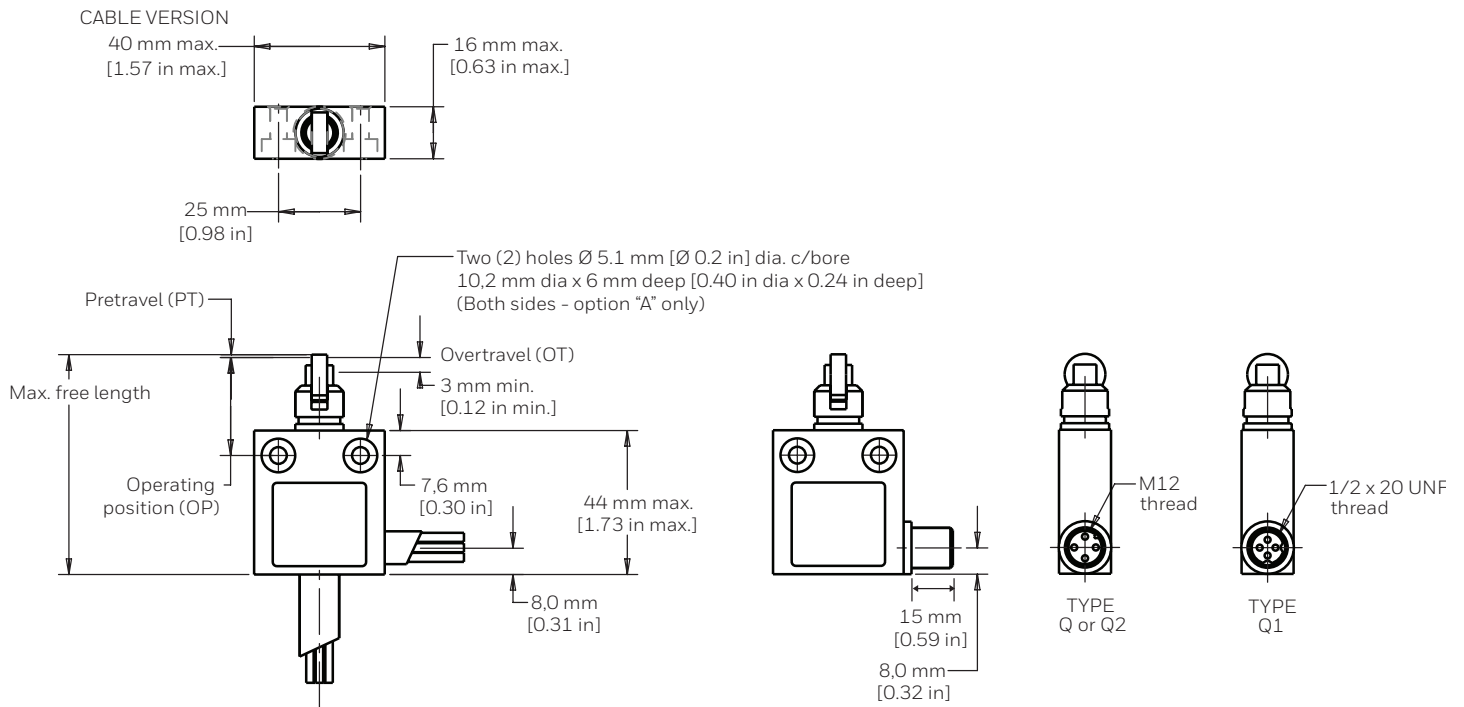

## PRODUCT NOMENCLATURE

914CE	29	3			
Switch Type	Actuator Type	Cable Length*	Options <sup>1</sup>	Connectors*	
<b>914CE</b> Series Small Precision Limit Switch	<b>1</b> Top pin plunger	<b>22</b> Manually oper. nylon button	<b>3</b> 3 feet	<b>A</b> Side entry	<b>Q</b> dc type single keyway
	<b>2</b> Top roller plunger, parallel	<b>27</b> Top pin plunger, panel mount	<b>6</b> 6 feet	<b>G</b> Gold contacts	<b>Q1</b> ac type two keyways
	<b>3</b> Top roller plunger, perp.	<b>28</b> Top roller plunger, parallel panel mount	<b>9</b> 9 feet	<b>P</b> Top mounting	<b>Q2</b> dc type optional pin-out
	<b>16</b> Side rotary	<b>29</b> Top roller plunger, perp. panel mount	<b>12</b> 12 feet	<b>L1</b> Low temp. -40 °C, cable not for flexing	
	<b>18</b> Top pin plunger w/ boot seal	<b>31</b> Top roller plunger, parallel boot seal	<b>15</b> 15 feet	<b>V</b> Viton® seals/gasket (side rotary and booted sealed plungers only)	
	<b>19</b> Top adjustable pin plunger	<b>55</b> Top roller plunger, perp. boot seal			
	<b>20</b> Coil wobble	<b>66</b> Top ball bearing plunger			

Bottom exit is standard.

NOTE: not all combinations of model codes are available. Please contact your Honeywell provider/representative for assistance.

\*Select "Cable Length" or "Connectors".

<sup>1</sup>More than one option may be permissible.

# MICRO SWITCH MINIATURE PRECISION LIMIT SWITCHES, 914CE SERIES

## PRODUCT SPECIFICATIONS AND LISTINGS

Contact your Honeywell rep or distributor for additional listings

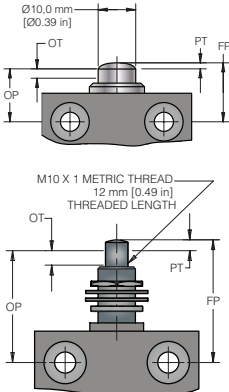
914CE1 • Pin Plunger 914CE27 • Pin Plunger Panel Mount	Contacts	Elec Rating	Cable/ Connector Position	Free Position (FP)	Operating Position (OP)	Options	Listing
 <p><b>Pretravel</b> • 1,8 mm [0.071 in]  <b>Diff. travel</b> • 0,1 mm [0.004 in]  <b>Overtravel</b> • 3,0 mm [0.118 in]  <b>Oper. force</b> • 12,2 N [2.75 in-lb]</p>	Silver	A	Bottom	17,5 mm [0.69 in]	15,7 mm [0.62 in]	–	<b>914CE1-3</b>
	Gold	B	Bottom	17,5 mm [0.69 in]	15,7 mm [0.62 in]	–	<b>914CE1-3G</b>
	Silver	A	Side	17,5 mm [0.69 in]	15,7 mm [0.62 in]	–	<b>914CE1-3A</b>
	Silver	A	Bottom	31,1 mm [1.23 in]	29,3 mm [1.15 in]	Panel mount	<b>914CE27-3</b>
	Silver	C	Bottom	17,5 mm [0.69 in]	15,7 mm [0.62 in]	dc-type, single keyway	<b>914CE1-Q</b>
	Silver	C	Bottom	17,5 mm [0.69 in]	15,7 mm [0.62 in]	ac-type, two keyways	<b>914CE1-Q1</b>
914CE18 • Boot Sealed Pin Plunger	Contacts	Elec Rating	Cable/ Connector Position	Free Position (FP)	Operating Position (OP)	Options	Listing
 <p><b>Pretravel</b> • 1,8 mm [0.071 in]  <b>Diff. travel</b> • 0,1 mm [0.004 in]  <b>Overtravel</b> • 3,0 mm [0.118 in]  <b>Oper. force</b> • 22,2 N [5 in-lb]</p>	Silver	A	Bottom	26,7 mm [1.05 in]	24,9 mm [0.98 in]	–	<b>914CE18-3</b>
	Silver	A	Side	26,7 mm [1.05 in]	24,9 mm [0.98 in]	–	<b>914CE18-3A</b>
	Silver	A	Bottom	26,7 mm [1.05 in]	24,9 mm [0.98 in]	Fluorocarbon seals	<b>914CE18-3V</b>
	Silver	C	Bottom	26,7 mm [1.05 in]	24,9 mm [0.98 in]	ac-type, two keyways	<b>914CE18-Q1</b>
	Silver	C	Side	26,7 mm [1.05 in]	24,9 mm [0.98 in]	ac-type, two keyways	<b>914CE18-AQ1</b>
914CE66 • Ball Bearing Plunger	Contacts	Elec Rating	Cable/ Connector Position	Free Position (FP)	Operating Position (OP)	Options	Listing
 <p><b>Pretravel</b> • 1,8 mm [0.071 in]  <b>Diff. travel</b> • 0,1 mm [0.004 in]  <b>Overtravel</b> • 3,0 mm [0.118 in]  <b>Oper. force</b> • 12,2 N [2.75 in-lb]</p>	Silver	A	Bottom	26,2 mm [1.03 in]	24,4 mm [0.96 in]	–	<b>914CE66-3</b>

# MICRO SWITCH MINIATURE PRECISION LIMIT SWITCHES, 914CE SERIES

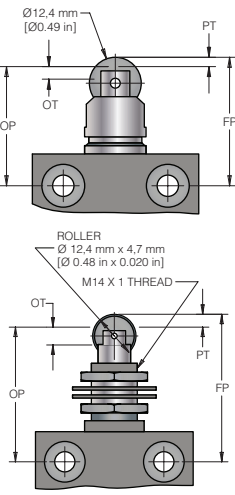
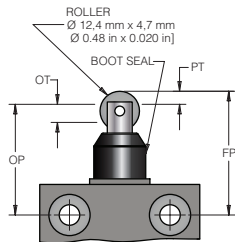
<b>914CE2 • Roller Plunger</b> <b>914CE28 • Roller Plunger Panel Mount</b>	Contacts	Elec Rating	Cable/ Connector Position	Free Position (FP)	Operating Position (OP)	Options	Listing
 <p> <b>Pretravel</b> • 1,8 mm [0.071 in]  <b>Diff. travel</b> • 0,1 mm [0.004 in]  <b>Overtravel</b> • 3,0 mm [0.118 in]  <b>Oper. force</b> • 12,2 N [2.75 in-lb]         </p>	Silver	A	Bottom	30,3 mm [1.19 in]	28,5 mm [1.12 in]	–	<b>914CE2-3</b>
	Gold	B	Bottom	30,3 mm [1.19 in]	28,5 mm [1.12 in]	–	<b>914CE2-3G</b>
	Silver	C	Bottom	30,3 mm [1.19 in]	28,5 mm [1.12 in]	ac-type, two keyways	<b>914CE2-Q1</b>
	Silver	C	Bottom	30,3 mm [1.19 in]	28,5 mm [1.12 in]	dc-type, single keyway	<b>914CE2-Q</b>
	Silver	A	Side	30,3 mm [1.19 in]	28,5 mm [1.12 in]	–	<b>914CE2-3A</b>
	Silver	A	Bottom	44,3 mm [1.75 in]	42,5 mm [1.67 in]	Panel mount	<b>914CE28-3</b>
	Silver	C	Bottom	44,3 mm [1.75 in]	42,5 mm [1.67 in]	Panel mount, ac-type, two keyways	<b>914CE28-Q1</b>
<b>914CE31 • Boot Sealed Roller Plunger</b>	Contacts	Elec Rating	Cable/ Connector Position	Free Position (FP)	Operating Position (OP)	Options	Listing
 <p> <b>Pretravel</b> • 1,8 mm [0.071 in]  <b>Diff. travel</b> • 0,1 mm [0.004 in]  <b>Overtravel</b> • 3,0 mm [0.118 in]  <b>Oper. force</b> • 22,2 N [5 in-lb]         </p>	Silver	A	Bottom	36,2 mm [1.43 in]	34,4 mm [1.36 in]	–	<b>914CE31-3</b>
	Silver	A	Bottom	36,2 mm [1.43 in]	34,4 mm [1.36 in]	Fluorocarbon seals	<b>914CE31-3V</b>

# MICRO SWITCH MINIATURE PRECISION LIMIT SWITCHES, 914CE SERIES

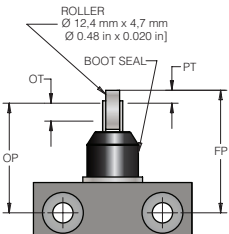
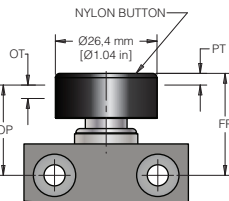
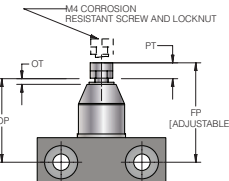
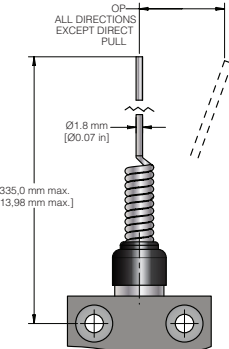
914CE55 • Boot Sealed Cross Roller Plunger	Contacts	Elec Rating	Cable/ Connector Position	Free Position (FP)	Operating Position (OP)	Options	Listing
 <p>ROLLER Ø 12.4 mm x 4.7 mm Ø 0.48 in x 0.020 in</p> <p>BOOT SEAL</p> <p>OT</p> <p>OP</p> <p>FP</p> <p>PT</p> <p><b>Pretravel</b> • 1,8 mm [0.071 in] <b>Diff. travel</b> • 0,1 mm [0.004 in] <b>Overtravel</b> • 3,0 mm [0.118 in] <b>Oper. force</b> • 22,2 N [5 in-lb]</p>	Silver	A	Bottom	36,2 mm [1.43 in]	34,4 mm [1.36 in]	–	<b>914CE55-3</b>
914CE22 • Manually Operated	Contacts	Elec Rating	Cable/ Connector Position	Free Position (FP)	Operating Position (OP)	Options	Listing
 <p>NYLON BUTTON</p> <p>Ø 26.4 mm [Ø 1.04 in]</p> <p>OT</p> <p>OP</p> <p>FP</p> <p>PT</p> <p><b>Pretravel</b> • 1,8 mm [0.071 in] <b>Diff. travel</b> • 0,1 mm [0.004 in] <b>Overtravel</b> • 3,0 mm [0.118 in] <b>Oper. force</b> • 8,9 N [2 in-lb]</p>	Silver	A	Bottom	29,2 mm [1.15 in]	27,4 mm [1.08]	23,9 mm [0.94 in] dia. button	<b>914CE22-3</b>
914CE19 • Adjustable Plunger	Contacts	Elec Rating	Cable/ Connector Position	Free Position (FP)	Operating Position (OP)	Options	Listing
 <p>M4 CORROSION RESISTANT SCREW AND LOCKNUT</p> <p>OT</p> <p>OP</p> <p>FP [ADJUSTABLE]</p> <p>PT</p> <p><b>Pretravel</b> • 1,8 mm [0.071 in] <b>Diff. travel</b> • 0,1 mm [0.004 in] <b>Overtravel</b> • 3,0 mm [0.118 in] <b>Oper. force</b> • 17,5 N [5 lb]</p>	Silver	A	Bottom	Adjust. 33,8 mm to 40,8 mm [1.33 in to 1.61 in]	Adjust. 32 mm to 39 mm [1.26 in to 1.54 in]	–	<b>914CE19-3</b>
	Gold	B	Bottom			–	<b>914CE19-3G</b>
	Silver	A	Side			–	<b>914CE19-3A</b>
	Silver	C	Bottom			ac-type, two keyways	<b>914CE19-Q1</b>
914CE20 • Random Motion Wire Actuator	Contacts	Elec Rating	Cable/ Connector Position	Free Position (FP)	Operating Position (OP)	Options	Listing
 <p>OP</p> <p>ALL DIRECTIONS EXCEPT DIRECT PULL</p> <p>Ø 1.8 mm [Ø 0.07 in]</p> <p>335,0 mm max. [13,98 mm max.]</p> <p><b>Oper. point</b> • 28 mm [1.10 in] max. <b>Oper. force</b> • 0,55 N [0.12 lb] max.</p>	Silver	A	Bottom	–	–	–	<b>914CE20-3</b>
	Silver	A	Side	–	–	–	<b>914CE20-3A</b>
	Silver	C	Bottom	–	–	dc-type, single keyway	<b>914CE20-Q</b>



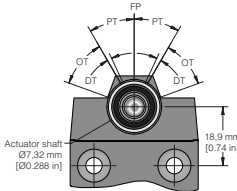

# MICRO SWITCH MINIATURE PRECISION LIMIT SWITCHES, 914CE SERIES

914CE16 • Side Rotary	Contacts	Elec Rating	Cable/ Connector Position	Free Position (FP)	Operating Position (OP)	Options	Listing
 <p> <b>Pretravel • 30°</b>  <b>Diff. travel • 3°</b>  <b>Overtravel • 40°</b>  <b>Oper. force • 0,34 Nm [3 in-lb]</b> </p>	Silver	A	Bottom	–	–	–	<b>914CE16-3<sup>1</sup></b>
	Silver	A	Side	–	–	–	<b>914CE16-3A<sup>1</sup></b>
	Silver	C	Bottom	–	–	ac-type, two keyways	<b>914CE16-Q1<sup>1</sup></b>
	Silver	C	Bottom	–	–	dc-type, single keyway	<b>914CE16-Q<sup>1</sup></b>
	Silver	C	Side	–	–	ac-type, two keyways	<b>914CE16-AQ1<sup>1</sup></b>

<sup>1</sup> Switch operates on clockwise and counterclockwise rotation of lever shaft.

Note: part numbers are shown with 3 ft of cable. The -X indicates the number of feet of cable provided. 6-foot, 9-foot, and 12-foot lengths along with custom lengths, are also available.

**TABLE 3. LEVERS FOR 914CE16 SERIES SIDE ROTARY SWITCHES**

Catalog Listing	Material	Rod/ Roller Dia. mm [in]	Rod/ Roller Width mm [in]	Roller Mounting	
<b>Fixed 38,1 mm [1.5 in] radius</b>					
	–	Roller-less	n/a	n/a	
LSZ51A	Nylon	19 [0.75]	6,35 [0.25]	Front	
LSZ51B	Steel	19 [0.75]	6,35 [0.25]	Front	
LSZ51C	Nylon	19 [0.75]	6,35 [0.25]	Back	
LSZ51D	Steel	19 [0.75]	6,35 [0.25]	Back	
LSZ51L	Ball bearing	19 [0.75]	6,35 [0.25]	Back	
LSZ51P	Nylon	19 [0.75]	12,7 [0.50]	Front	
<b>Adjustable 38,1 mm to 89,0 mm [1.5 in to 3.5 in] radius</b>					
	–	Roller-less	n/a	n/a	
LSZ52A	Nylon	19 [0.75]	6,35 [0.25]	Back	
LSZ52B	Steel	19 [0.75]	6,35 [0.25]	Back	
LSZ52C	Nylon	19 [0.75]	6,35 [0.25]	Front	
LSZ52D	Steel	19 [0.75]	6,35 [0.25]	Front	
LSZ52L	Ball bearing	19 [0.75]	6,35 [0.25]	Front	
<b>Fixed 38,1 mm [1.5 in] radius</b>					
	–	Roller-less	n/a	n/a	
LSZ55A	Nylon	19 [0.75]	6,35 [0.25]	Back	
LSZ55B	Steel	19 [0.75]	6,35 [0.25]	Back	
LSZ55C	Nylon	19 [0.75]	6,35 [0.25]	Front	
LSZ55D	Steel	19 [0.75]	6,35 [0.25]	Front	
<b>Short fixed - 33 mm [1.3 in] radius</b>					
	LSZ59A	Nylon	19 [0.75]	6,35 [0.25]	Front
	LSZ59B	Steel	19 [0.75]	6,35 [0.25]	Front
	LSZ59C	Nylon	19 [0.75]	6,35 [0.25]	Back
	LSZ59D	Steel	19 [0.75]	6,35 [0.25]	Back
<b>38,1 mm [1.5 in] radius one-way roller lever</b>					
	LSZ60A	Nylon	19 [0.75]	6,35 [0.25]	Front
	LSZ60B	Steel	19 [0.75]	6,35 [0.25]	Front

## WARRANTY/REMEDY

Honeywell warrants goods of its manufacture as being free of defective materials and faulty workmanship during the applicable warranty period. Honeywell's standard product warranty applies unless agreed to otherwise by Honeywell in writing; please refer to your order acknowledgment or consult your local sales office for specific warranty details. If warranted goods are returned to Honeywell during the period of coverage, Honeywell will repair or replace, at its option, without charge those items that Honeywell, in its sole discretion, finds defective. The foregoing is buyer's sole remedy and is in lieu of all other warranties, expressed or implied, including those of merchantability and fitness for a particular purpose. In no event shall Honeywell be liable for consequential, special, or indirect damages.

While Honeywell may provide application assistance personally, through our literature and the Honeywell web site, it is buyer's sole responsibility to determine the suitability of the product in the application.

Specifications may change without notice. The information we supply is believed to be accurate and reliable as of this writing. However, Honeywell assumes no responsibility for its use.

## FOR MORE INFORMATION

Honeywell Advanced Sensing Technologies services its customers through a worldwide network of sales offices and distributors. For application assistance, current specifications, pricing or the nearest Authorized Distributor, visit [our website](#) or call:

USA/Canada	+1 302 613 4491
Latin America	+1 305 805 8188
Europe	+44 1344 238258
Japan	+81 (0) 3-6730-7152
Singapore	+65 6355 2828
Greater China	+86 4006396841

### Honeywell Advanced Sensing Technologies

830 East Arapaho Road  
Richardson, TX 75081  
[sps.honeywell.com/ast](http://sps.honeywell.com/ast)

002381-10-EN | 10 | 06/21  
© 2021 Honeywell International Inc. All rights reserved.

## WARNING MISUSE OF DOCUMENTATION

- The information presented in this product sheet is for reference only. Do not use this document as a product installation guide.
- Complete installation, operation, and maintenance information is provided in the instructions supplied with each product.

**Failure to comply with these instructions could result in death or serious injury.**

**Honeywell**

## Looking for pricing, stock, or lifecycle information?

Click below to explore more details on WIN SOURCE:

 [View 914CE1-3A on WIN SOURCE](#)

 [Honeywell Information](#)

## Optimize Your Supply Chain with WIN SOURCE Solutions

-  Global Sourcing Solution
-  Obsolete Management
-  Cost Control Management
-  Shortage Management
-  Alternative Solution
-  Excess Inventory Management