



**THE DATASHEET OF
CL-SA-12C4-22**



SLIDE SWITCHES

CL-SA

RoHS compliant

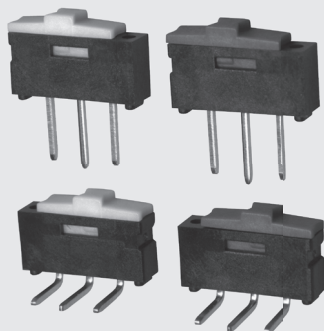

FEATURES

- Correspond to rating current 500mA
- Possible to continue mounting with 2.54mm pitch
- RoHS compliant
- Resin material is UL Recognized 94V-0

INTERNAL STRUCTURE

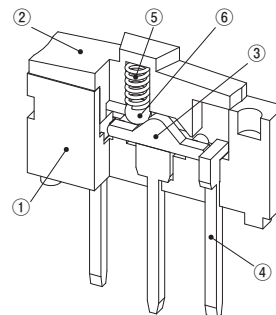

Part name	Material
① Housing	Polyamido
② Slider	Polyamido
③ Slider contact	Copper alloy, Gold-plated
④ Terminal pin	Copper alloy, Gold-plated
⑤ Click spring	Stainless steel(SUS304)
⑥ Click ball	Stainless steel(SUS304)

PART NUMBER DESIGNATION

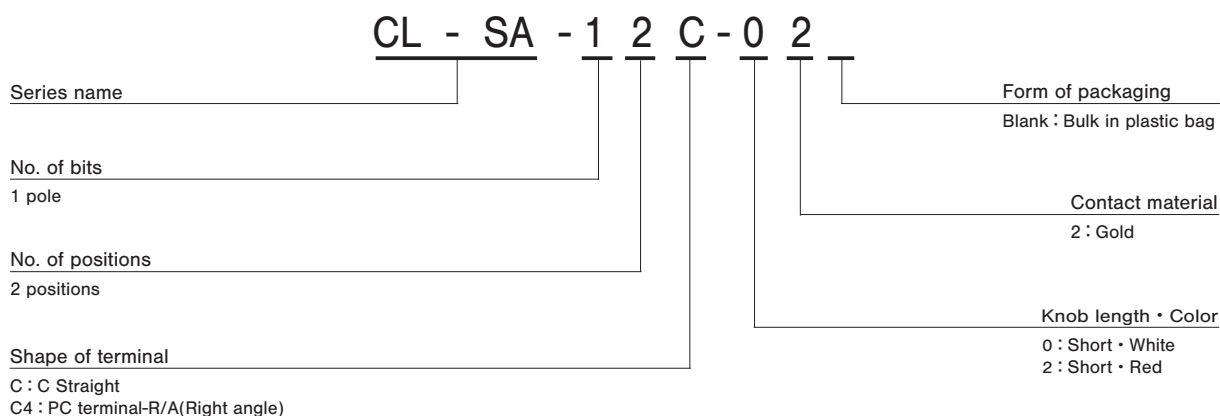

※ Please refer to the LIST OF PART NUMBERS when placing orders.

CL-SA

SLIDE SWITCHES

LIST OF PART NUMBERS

No. of poles	No. of contacts	Contact material	Knob length • Color	Shape of terminal	Part number	From of packaging	Packaging quantity
1	2	Gold	Short • White	PC Straight	CL-SA-12C-02	Plastic bag	50pcs./pack
			Short • Red		CL-SA-12C-22		
			Short • White	PC Straight-R/A	CL-SA-12C4-02		
			Short • Red		CL-SA-12C4-22		

STANDARD SPECIFICATIONS

Operating temp. range	- 40 ~ 85 °C
Storage temp. range	
Sealing	Non- Washable

ELECTRICAL CHARACTERISTICS

Contact rating Non-switching Switching Minimum	DC50 V, 500mA DC12 V , 500mA DC20 mV ,1 μA
Initial contact resistance	22 mΩ maximum
Insulation resistance	10,000 MΩ minimum (DC100 V)
Dielectric strength	AC500 V,60 s

MECHANICAL CHARACTERISTICS

Stroke	1.6 mm	
Operation force	2.5 ± 1.5 N {0.26 ± 0.15 kgf}	
Load life	Rated load	2,000 cycles
	No load	10,000 cycles
Soldering heat	Flow : 260 °C±3 5 ~ 6 s 2 times max. ※ Except a right angle(CL-SA-12C4-*2)	
	Manual soldering : 380 ± 10 °C , 3 ~ 4 s	

PACKAGING SPECIFICATION

Plastic bag	50pcs./ pack
-------------	--------------

CL-SA SLIDE SWITCHES

OUTLINE DIMENSIONS

Unless otherwise specified, tolerance: ± 0.3 (Unit: mm)

- CL-SA-12C-02
- CL-SA-12C-22

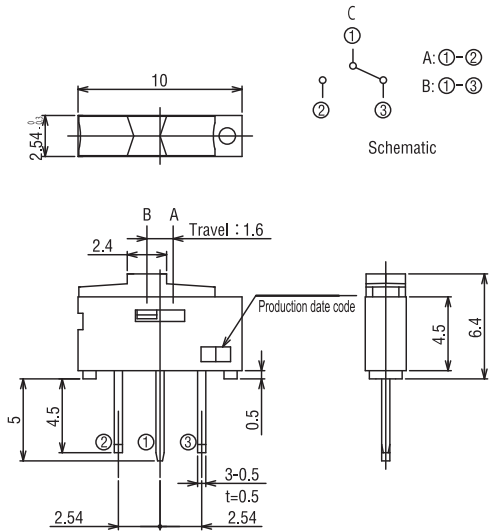

- CL-SA-12C4-02
- CL-SA-12C4-22

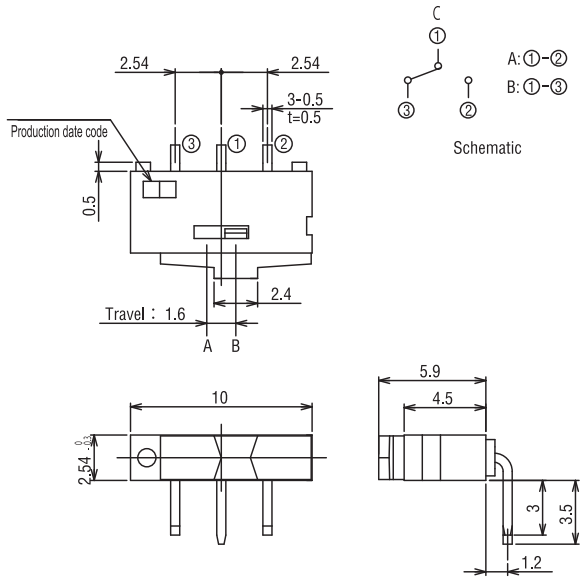

SIZE OF P.C.B. PROCESSING

(Unit : mm)

- CL-SA-12C-02
- CL-SA-12C-22

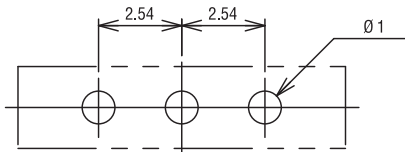

- CL-SA-12C4-02
- CL-SA-12C4-22

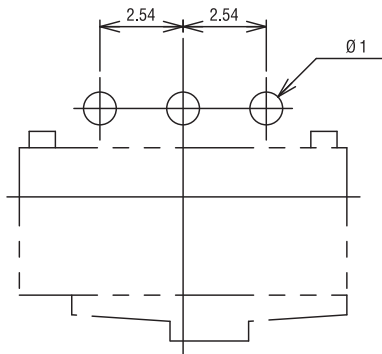

PACKAGING SPECIFICATIONS

<Bulk pack specifications>

- The smallest unit of bulk pack in plastic bag is 10 pcs. per pack. Orders will be accepted for unit of minimum 10 pcs., i.e., 10, 20, 30 pcs., etc.
- Boxing of bulk in a plastic bag is performed with 50 pcs. (standard 100 pcs.) per box.

Looking for pricing, stock, or lifecycle information?

Click below to explore more details on WIN SOURCE:

- ⊖ [View CL-SA-12C4-22 on WIN SOURCE](#)
- ⊖ [Nidec Copal Electronics Information](#)

Optimize Your Supply Chain with WIN SOURCE Solutions

- ✓ Global Sourcing Solution
- ✓ Obsolete Management
- ✓ Cost Control Management
- ✓ Shortage Management
- ✓ Alternative Solution
- ✓ Excess Inventory Management