



# THE DATASHEET OF D2S-5L



# D2S

## Subminiature Basic Switch

### Subminiature Switch with Superb Flux Resistance

- One-piece terminal construction to keep out flux.
- High operating-position accuracy ( $\pm 0.25$  mm) enables easy peripheral design and positioning. Use of pin plunger also allows horizontal operation.

RoHS Compliant

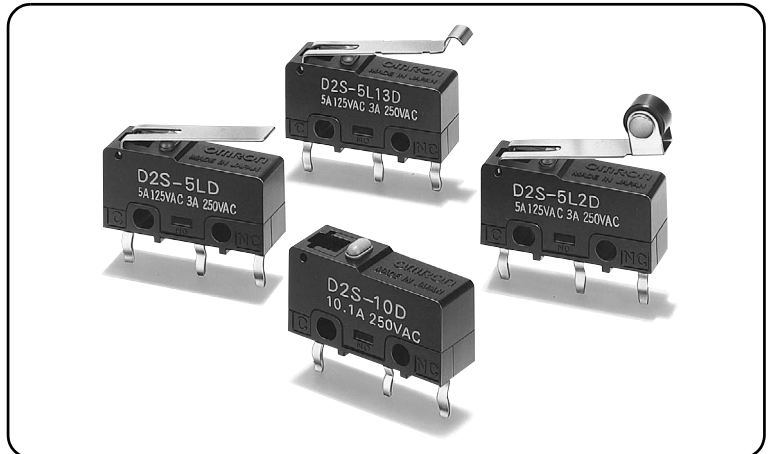

### Model Number Legend

D2S - 1 2 3 4

#### 1. Ratings

10: 250 VAC 10.1 A  
5 : 125 VAC 5 A  
01: 30 VDC 0.1 A

#### 2. Actuator

None: Pin plunger  
L : Hinge lever  
L13 : Simulated roller lever  
L2 : Hinge roller lever





#### 3. Maximum Operating Force (OF)

None: 1.47 N {150 gf}  
-F : 0.49 N {50 gf} (For 0.1 A, 5 A)  
Note: The given values are for pin plunger models only.

#### 4. Terminals

None: Solder terminals  
D : Self-clinching PCB terminals

### List of Models

Actuator	Terminals	Ratings	10.1 A	5 A	0.1 A
		OF max.			
Pin plunger 	Solder terminals	1.47 N {150 gf}	<b>D2S-10</b>	<b>D2S-5</b>	<b>D2S-01</b>
		0.49 N {50 gf}	-	<b>D2S-5-F</b>	<b>D2S-01-F</b>
	Self-clinching PCB terminals	1.47 N {150 gf}	<b>D2S-10D</b>	<b>D2S-5D</b>	<b>D2S-01D</b>
		0.49 N {50 gf}	-	<b>D2S-5-FD</b>	<b>D2S-01-FD</b>
Hinge lever 	Solder terminals	0.49 N {50 gf}	<b>D2S-10L</b>	<b>D2S-5L</b>	<b>D2S-01L</b>
		0.18 N {18 gf}	-	<b>D2S-5L-F</b>	<b>D2S-01L-F</b>
	Self-clinching PCB terminals	0.49 N {50 gf}	<b>D2S-10LD</b>	<b>D2S-5LD</b>	<b>D2S-01LD</b>
		0.18 N {18 gf}	-	<b>D2S-5L-FD</b>	<b>D2S-01L-FD</b>
Simulated roller lever 	Solder terminals	0.49 N {50 gf}	<b>D2S-10L13</b>	<b>D2S-5L13</b>	<b>D2S-01L13</b>
		0.18 N {18 gf}	-	<b>D2S-5L13-F</b>	<b>D2S-01L13-F</b>
	Self-clinching PCB terminals	0.49 N {50 gf}	<b>D2S-10L13D</b>	<b>D2S-5L13D</b>	<b>D2S-01L13D</b>
		0.18 N {18 gf}	-	<b>D2S-5L13-FD</b>	<b>D2S-01L13-FD</b>
Hinge roller lever 	Solder terminals	0.49 N {50 gf}	<b>D2S-10L2</b>	<b>D2S-5L2</b>	<b>D2S-01L2</b>
		0.18 N {18 gf}	-	<b>D2S-5L2-F</b>	<b>D2S-01L2-F</b>
	Self-clinching PCB terminals	0.49 N {50 gf}	<b>D2S-10L2D</b>	<b>D2S-5L2D</b>	<b>D2S-01L2D</b>
		0.18 N {18 gf}	-	<b>D2S-5L2-FD</b>	<b>D2S-01L2-FD</b>

Separator (Sold Separately), Terminal Connector (Sold Separately) ➔ Refer to "Basic Switch Common Accessories"

## Contact Form

### ●SPDT

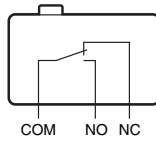

## Contact Specifications

Item	Model	D2S-10 models	D2S-5 models	D2S-01 models
Contact	Specification	Rivet		Crossbar
	Material	Silver alloy		Gold alloy
	Gap (standard value)	0.5 mm		
Inrush current	NC	20A max.		1 A max.
	NO	15 A max.	10 A max.	1 A max.
Minimum applicable load (reference value) *		5 VDC 160 mA		5 VDC 1 mA

\* Please refer to "Using Micro Loads" of "●Precautions" for more information on the minimum applicable load.

## Ratings

Model	Item Rated voltage	Resistive load
D2S-10 models	250 VAC	10.1 A
D2S-5 models	125 VAC	5 A
	250 VAC	3 A
D2S-01 models	125 VAC	0.1 A
	30 VDC	0.1 A

Note. The above rating values apply under the following test conditions.  
 (1) Ambient temperature: 20±2°C  
 (2) Ambient humidity: 65±5%  
 (3) Operating frequency: 30 operations/min

## Approved Safety Standards

The items shown in the "List of Models" are not standard approved models. Consult your OMRON sales representative for specific models with standard approvals.

### UL (UL1054)/CSA(CSA C22.2 No.55)

Rated voltage	Model	D2S-10	D2S-5	D2S-01
125 VAC 250 V	-	10.1 A	5 A 3 A	0.1 A -
30 VDC	-	-	-	0.1 A

## Characteristics

Item	Model	D2S-10 models	D2S-5 models	D2S-01 models
Permissible operating speed		0.1 mm to 1 m/s (for pin plunger models)		
Permissible operating frequency	Mechanical	400 operations/min		
	Electrical	60 operations/min		
Insulation resistance		100 MΩ min. (at 500 VDC with insulation tester)		
Contact resistance (initial value)	OF 1.47 N models	30mΩ max.		50 mΩ max.
	OF 0.49 N models	-	50 mΩ max.	100 mΩ max.
Dielectric strength * 1	Between terminals of the same polarity	1,000 VAC 50/60 Hz 1 min		
	Between current-carrying metal parts and ground	1,500 VAC 50/60 Hz 1 min		
	Between each terminals and non-current-carrying metal parts	1,500 VAC 50/60 Hz 1 min		
Vibration resistance * 2	Malfunction	10 to 55 Hz, 1.5 mm double amplitude		
Shock resistance	Durability	OF 1.47 N models	1,000 m/s <sup>2</sup> (approx. 100G) max.	
		OF 0.49 N models	500 m/s <sup>2</sup> (approx. 50G) max.	
	Malfunction * 2	OF 1.47 N models	300 m/s <sup>2</sup> (approx. 30G) max.	
		OF 0.49 models	200 m/s <sup>2</sup> (approx. 20G) max.	
Durability * 3	Mechanical	10,000,000 operations min. (60 operations/min)	30,000,000 operations min. (60 operations/min)	
	Electrical	50,000 operations min. (30 operations/min)	200,000 operations min. (30 operations/min)	
Degree of protection		IEC IP40		
Ambient operating temperature		-25°C to +85°C (at ambient humidity of 60% max.) (with no icing or condensation)		
Ambient operating humidity		85% max. (for +5°C to +35°C)		
Weight		Approx. 1.6 g (pin plunger models)		

Note. The data given above are initial values.

- \*1. The values for dielectric strength shown are for models with a Separator (refer to "Micro Switch Common Accessories").
- \*2. The values are at Free Position and Total Travel Position values for pin plunger, and Total Travel Position value for lever. Close or open circuit of the contact is 1ms max.
- \*3. For testing conditions, consult your OMRON sales representative.

## Terminals/Apearances (Unit: mm)

### ●Solder terminals

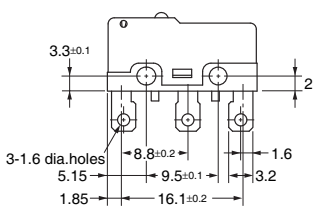

### ●Self-clinching PCB terminals

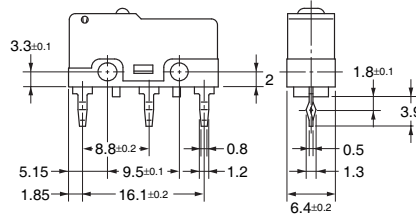

### <PCB Mounting Dimensions (Reference)>

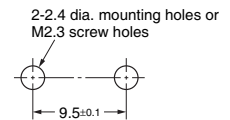
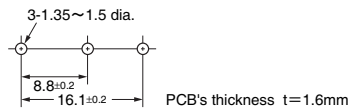

## Dimensions (Unit: mm) and Operating Characteristics

The following figures show models with self-clinching PCB terminals. For the solder terminals, refer to "Terminals/Apearances".

The □ is replaced with the code for the terminal that you need. See the "List of Models" for available combinations of models.

### ●Pin plunger

- D2S-10□
- D2S-5□
- D2S-5-F□
- D2S-01□
- D2S-01-F□

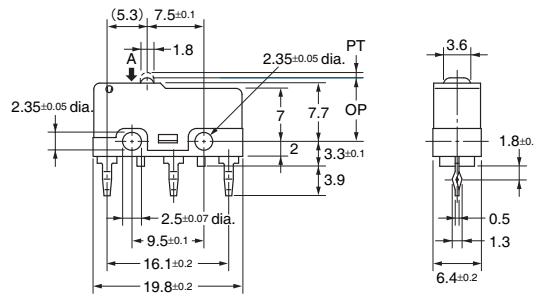

Operating characteristics	Model		D2S-10□	D2S-5-F□
			D2S-5□	D2S-01-F□
Operating Force	OF	Max.	1.47 N {150 gf}	0.49 N {50 gf}
Releasing Force	RF	Min.	0.25 N {25 gf}	0.04 N {4 gf}
Pretravel	PT	Max.	0.7 mm	
Overtravel	OT	Min.	0.4 mm	
Movement Differential	MD	Max.	0.1 mm	
Operating Position	OP		8.4±0.25 mm	

### ●Hinge lever

- D2S-10L□
- D2S-5L□
- D2S-5L-F□
- D2S-01L□
- D2S-01L-F□

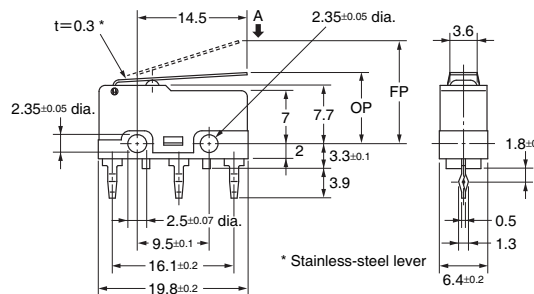

Operating characteristics	Model		D2S-10L□	D2S-5L-F□
			D2S-5L□	D2S-01L-F□
Operating Force	OF	Max.	0.49 N {50 gf}	0.18 N {18 gf}
Releasing Force	RF	Min.	0.06 N {6 gf}	0.02 N {2 gf}
Overtravel	OT	Min.	1.0 mm	
Movement Differential	MD	Max.	0.8 mm	
Free Position	FP	Max.	13.6 mm	
Operating Position	OP		9.4±0.8mm	

### ●Simulated roller lever

- D2S-10L13□
- D2S-5L13□
- D2S-5L13-F□
- D2S-01L13□
- D2S-01L13-F□

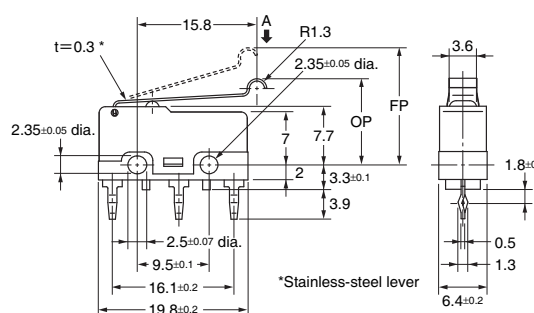
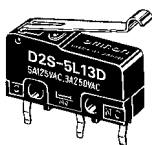

Operating characteristics	Model		D2S-10L13□	D2S-5L13-F□
			D2S-01L13□	D2S-01L13-F□
Operating Force	OF	Max.	0.49 N {50 gf}	0.18 N {18 gf}
Releasing Force	RF	Min.	0.06 N {6 gf}	0.02 N {2 gf}
Overtravel	OT	Min.	1.0 mm	
Movement Differential	MD	Max.	0.8 mm	
Free Position	FP	Max.	15.5 mm	
Operating Position	OP		11.4±0.8 mm	

Note 1. Unless otherwise specified, a tolerance of ±0.4 mm applies to all dimensions.

Note 2. The operating characteristics are for operation in the A direction (↓).

●Hinge roller lever

- D2S-10L2□
- D2S-5L2□
- D2S-5L2-F□
- D2S-01L2□
- D2S-01L2-F□

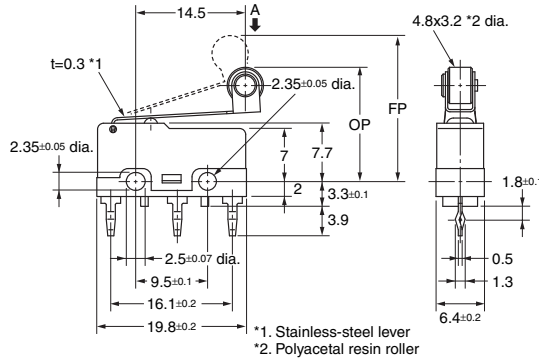
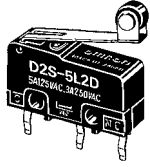

Operating characteristics		Model	D2S-10L2□ D2S-5L2□ D2S-01L2□	D2S-5L2-F□ D2S-01L2-F□
Operating Force	OF Max.		0.49 N {50 gf}	0.18 N {18 gf}
Releasing Force	RF Min.		0.06 N {6 gf}	0.02 N {2 gf}
Overtravel	OT Min.		1.0 mm	
Movement Differential	MD Max.		0.8 mm	
Free Position	FP Max.		19.3 mm	
Operating Position	OP		15.1±0.8 mm	

Note 1. Unless otherwise specified, a tolerance of ±0.4 mm applies to all dimensions.  
 Note 2. The operating characteristics are for operation in the A direction (↓).

## Precautions

★ Please refer to "Basic Switches Common Precautions" for correct use.

### Cautions

●Soldering

When using automatic soldering baths, we recommend soldering at 260±5°C within 5 seconds. Make sure that the liquid surface of the solder does not flow over the edge of the board.

When soldering terminals manually, complete the soldering at the iron tip temperature between 350 to 400°C within 3 seconds, and do not apply any external force for 1 minute after soldering. When applying solder, keep the solder away from the case of the Switch and do not allow solder or flux to flow into the case.

### Correct Use

●Mounting

Use M2.3 mounting screw with plane washers or spring washers to securely mount the Switch. Tighten the screws to a torque of 0.23 to 0.26 N·m {2.3 to 2.7 kgf·cm}.

●Using Micro Loads

Using a model for ordinary loads to open or close the contact of a micro load circuit may result in faulty contact. Use models that operate in the following range. However, even when using micro load models within the following operating range, if inrush current occurs when the contact is opened or closed, it may increase the contact wear and so decrease durability. Therefore, insert a contact protection circuit where necessary. The N-level reference value applies for the minimum applicable load. This value indicates the malfunction reference level for the reliability level of 60% ( $\lambda_{60}$ ).

(JIS C5003)

The equation,  $\lambda_{60}=0.5 \times 10^{-6} / \text{operations}$  indicates that the estimated malfunction rate is less than  $\frac{1}{2,000,000}$  operations with a reliability level of 60%.

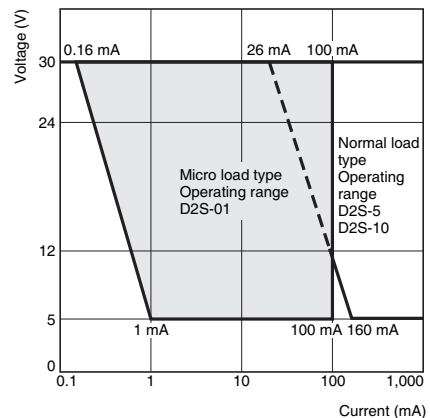



- Application examples provided in this document are for reference only. In actual applications, confirm equipment functions and safety before using the product.
- Consult your OMRON representative before using the product under conditions which are not described in the manual or applying the product to nuclear control systems, railroad systems, aviation systems, vehicles, combustion systems, medical equipment, amusement machines, safety equipment, and other systems or equipment that may have a serious influence on lives and property if used improperly. Make sure that the ratings and performance characteristics of the product provide a margin of safety for the system or equipment, and be sure to provide the system or equipment with double safety mechanisms.

**Note: Do not use this document to operate the Unit.**

## Looking for pricing, stock, or lifecycle information?

Click below to explore more details on WIN SOURCE:

-  [View D2S-5L on WIN SOURCE](#)
-  [Omron Information](#)

## Optimize Your Supply Chain with WIN SOURCE Solutions

-  Global Sourcing Solution
-  Obsolete Management
-  Cost Control Management
-  Shortage Management
-  Alternative Solution
-  Excess Inventory Management