



**THE DATASHEET OF
RE30E-400-213-1**



OPTICAL ENCODERS

RE30E

FEATURES

- With temp. compensation circuit
- With zero index signal
- Power supply voltage is for 5 ~ 12 V, 24V
- Economy type
- RoHS compliant

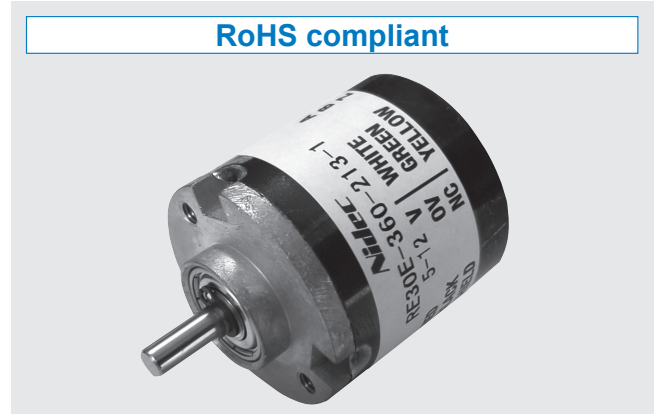

PART NUMBER DESIGNATION

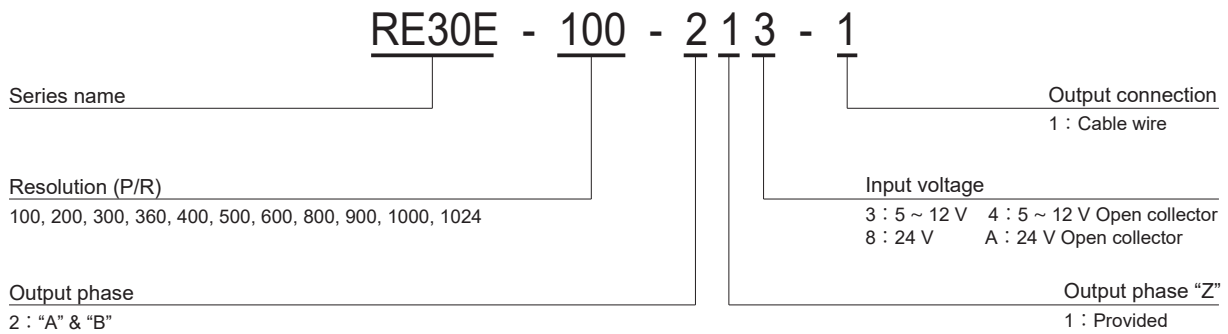

LIST OF PART NUMBERS

Resolution	Item	Input voltage			
		5 ~ 12 V	5 ~ 12 V Open collector	24 V	24 V Open collector
100 (P/R)	RE30E-100-213-1	⊕ RE30E-100-214-1	⊕ RE30E-100-218-1	⊕ RE30E-100-21A-1	
200 (P/R)	RE30E-200-213-1	⊕ RE30E-200-214-1	⊕ RE30E-200-218-1	⊕ RE30E-200-21A-1	
300 (P/R)	RE30E-300-213-1	⊕ RE30E-300-214-1	⊕ RE30E-300-218-1	⊕ RE30E-300-21A-1	
360 (P/R)	RE30E-360-213-1	⊕ RE30E-360-214-1	⊕ RE30E-360-218-1	⊕ RE30E-360-21A-1	
400 (P/R)	RE30E-400-213-1	⊕ RE30E-400-214-1	⊕ RE30E-400-218-1	⊕ RE30E-400-21A-1	
500 (P/R)	RE30E-500-213-1	⊕ RE30E-500-214-1	⊕ RE30E-500-218-1	⊕ RE30E-500-21A-1	
600 (P/R)	RE30E-600-213-1	⊕ RE30E-600-214-1	⊕ RE30E-600-218-1	⊕ RE30E-600-21A-1	
800 (P/R)	RE30E-800-213-1	⊕ RE30E-800-214-1	⊕ RE30E-800-218-1	⊕ RE30E-800-21A-1	
900 (P/R)	RE30E-900-213-1	⊕ RE30E-900-214-1	⊕ RE30E-900-218-1	⊕ RE30E-900-21A-1	
1000 (P/R)	RE30E-1000-213-1	⊕ RE30E-1000-214-1	⊕ RE30E-1000-218-1	⊕ RE30E-1000-21A-1	
1024 (P/R)	RE30E-1024-213-1	⊕ RE30E-1024-214-1	⊕ RE30E-1024-218-1	⊕ RE30E-1024-21A-1	

※ Verify the above part numbers when placing orders.

The products indicated by ⊕ mark are manufactured upon receipt of order basis.

STANDARD SPECIFICATIONS

Electrical characteristics

Input voltage	DC5~12 V ± 10 %	DC24 V ± 10 %
Input current	50 mA maximum	
Output wave form	Square wave	
Output phases	A, B, Z	
Resolution (P/R)	100, 200, 300, 360, 400, 500 600, 800, 900, 1000, 1024	
Phase difference of outputs A & B	90° ± 45°	
Maximum frequency response	10 kHz (100 P/R), 20 kHz (200P/R) 25 kHz (300 ~ 500 P/R), 60 kHz (600 P/R) 80 kHz (800 P/R), 90 kHz (900P/R) 100 kHz (1000 ~ 1024 P/R)	
Output signal	"1 (High)"	(Vcc - 1) V min. (Vcc - 2) V min.
	"0 (Low)"	+ 0.5 V max. + 1.0 V max.
Output impedance	2.2 kΩ	
Light source	LED	
Output Sink Current	80 mA maximum	

Mechanical characteristics

Starting torque	0.29 mN·m {3 gf·cm} maximum	
Inertia	2 g·cm ² maximum	
Shaft loading (When mounting)	Radial	19.6 N {2 kgf} maximum
	Axial	9.81 N {1 kgf} maximum
Net weight	Approx. 70 g	

Environmental characteristics

Operating temp. range	0 ~ 70 °C
Storage temp. range	- 20 ~ 80 °C
Protection grade	IP40

RELIABILITY TEST

The output wave form shall satisfy the STANDARD SPECIFICATIONS after the following tests.

Test item		Test conditions	
Vibration	Power OFF	Amplitude : 1.52 mm or 98.1 m/s ² (10 G) whichever is smaller. 10 ~ 500 Hz excursion 0.25 h/cycle, 8 cycles each for X, Y, Z, directions.	
Shock	Power OFF	3 times each in 6 directions (X, Y, Z) at 490 m/s ² (50 G), 11 ms.	
High temperature exposure	Power OFF	80 °C 96 h	To be measured after leaving samples for 1 h at normal temperature and humidity after the test.
	Power ON	70 °C 96 h	
Low temperature exposure	Power OFF	- 20 °C 96 h	
	Power ON	0 °C 96 h	
Humidity	Power OFF	To be measured after wiping out moisture and leaving samples for 1 h at normal temperature and humidity after the test.	
Thermal shock	Power OFF	To be done 10 cycles with the following condition (To be measured after leaving samples for 1 h at normal temperature and humidity after the test.) 80 °C 1 h, - 20 °C 1 h	

RE30E

OPTICAL ENCODERS

OUTLINE DIMENSIONS

Unless otherwise specified, tolerance: ± 0.4 (Unit: mm)

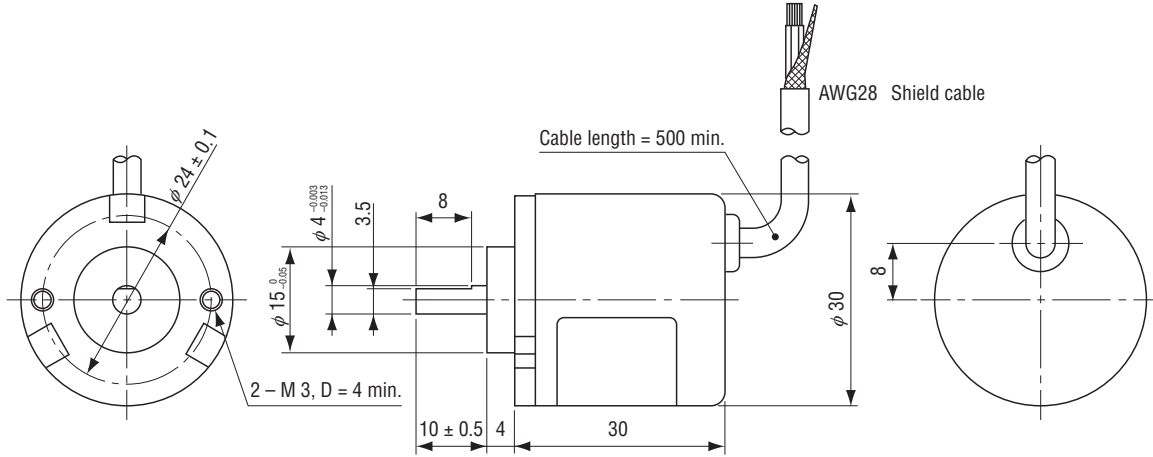

ELECTRICAL WIRING

Red	Power \oplus
Black	Power 0 (V)
White	Output "A"
Green	Output "B"
Yellow	Output "Z"
Cable shield	NC

OUTPUT

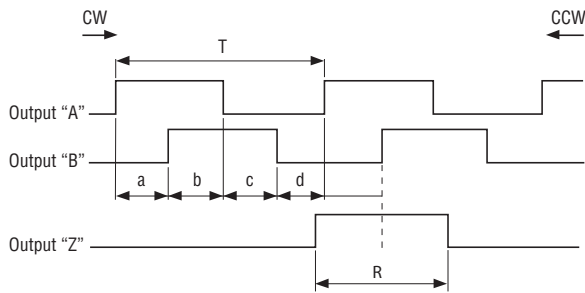

$a, b, c, d = 1/4T1/8T$
 $R = T3/4T$

The "Z" phase, however, includes no more than two "B" phase startups (CW rotation)

OUTPUT CIRCUIT

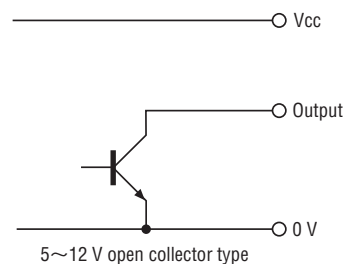
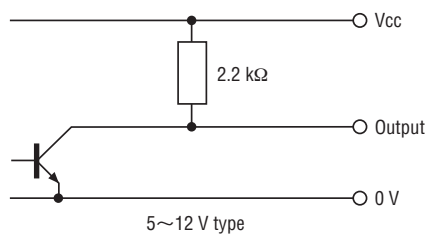

RE30E



Sink current of output circuit 80 mA maximum (at 25°C)

Looking for pricing, stock, or lifecycle information?

Click below to explore more details on WIN SOURCE:

-  [View RE30E-400-213-1 on WIN SOURCE](#)
-  [Nidec Copal Electronics Information](#)

Optimize Your Supply Chain with WIN SOURCE Solutions

-  Global Sourcing Solution
-  Obsolete Management
-  Cost Control Management
-  Shortage Management
-  Alternative Solution
-  Excess Inventory Management