

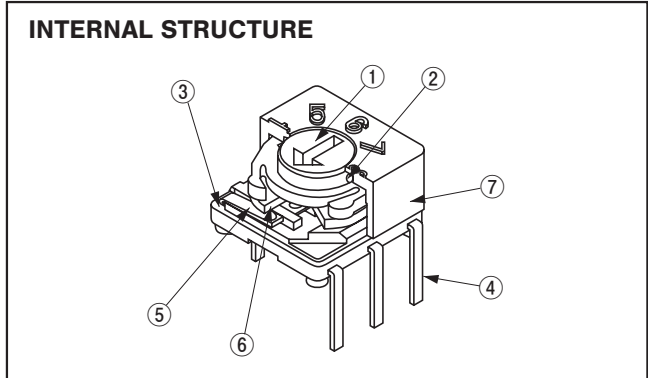

THE DATASHEET OF S-8011

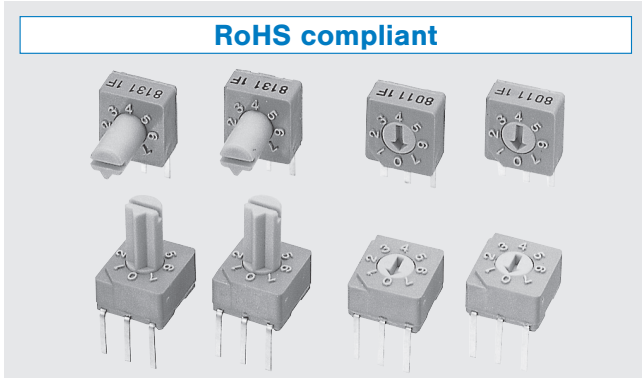



Part name	Material
① Rotor	Polyoxymethylene
② "O" ring	Silicone rubber
③ Base	Polybutyleneterephthalate
④ Terminal pin	Copper alloy, Gold-plated
⑤ contact	
⑥ P.C.B.	Gold-plated epoxy board
⑦ Housing	Polybutyleneterephthalate

FEATURES

- RoHS compliant
- 3 bits 8 positions type
- Protection against dust and washable after soldering
- DIP-pin configuration: 2.54 mm pitch
- Resin material is UL Recognized 94HB

PART NUMBER DESIGNATION

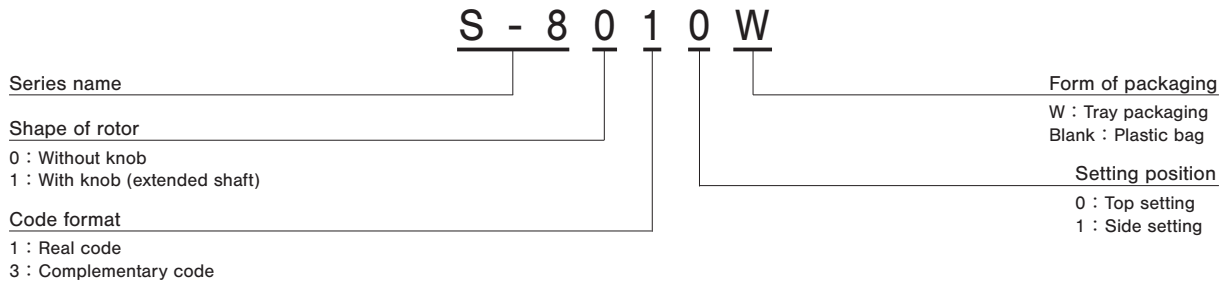

LIST OF PART NUMBERS

Shape	Form of packaging	Binary coded octal		Packaging quantity
		Real code	Complementary code	
Top setting	Tray packaging	S-8010W	S-8030W	50 pcs./tray
		S-8010	S-8030	100 pcs./pack
	Plastic bag	S-8110W	S-8130W	50 pcs./tray
		S-8110	S-8130	100 pcs./pack
Side setting	Tray packaging	S-8011W	S-8031W	50 pcs./tray
		S-8011	S-8031	100 pcs./pack
	Plastic bag	S-8111W	S-8131W	50 pcs./tray
		S-8111	S-8131	100 pcs./pack

※ Verify the above part numbers when placing orders.
Tray version can be supplied only in tray units.

S-8000

ROTARY CODED SWITCHES

STANDARD SPECIFICATIONS

Circuit type	BCO (Real code, complementary code)
Operating temp. range	-25 ~ 70 °C
Storage temp. range	
Sealing	Washable by "O" ring ※ Please refer to page 149,150
Net weight	Approx. 0.27 g (S-8010, S-8030) Approx. 0.34 g (S-8110, S-8130) Approx. 0.33 g (S-8011, S-8031) Approx. 0.40 g (S-8111, S-8131)

ELECTRICAL CHARACTERISTICS

Contact rating Non-switching Switching Minimum	DC50 V 100 mA DC5 V 100 mA DC20 mV 1 µA
Contact resistance	100 mΩ maximum
Insulation resistance	1000 MΩ (DC100 V) minimum
Dielectric strength	AC250 V, 60 s

MECHANICAL CHARACTERISTICS

No. of positions	8
Adjustment torque	36 mN·m {367 gf·cm} maximum
Stepping angle	45°
Terminal strength	10 N {1.02 kgf} minimum
Solderability	245 ± 3 °C, 2 ~ 3 s
Soldering heat	Flow : 260 ± 3 °C as the temperature in a pot of molten solder, immersion from head of terminal to backside of board, 5 ~ 6 s, two times maximum
	Manual soldering : 380 ± 10 °C, 3 ~ 4 s

ENVIRONMENTAL CHARACTERISTICS

Vibration	Amplitude 1.5 mm or Acceleration 98 m/s ² , 10-500-10 Hz, 3 directions for 2 h each
Shock	490 m/s ² , 11 ms 6 directions for 3 times each
Load life	10000 steps minimum DC5 V, 100 mA
Humidity (Steady state)	40 °C, Relative humidity 90 ~ 95 %, 240 h
High temp. exposure	70 °C, 96 h
Low temp. exposure	-25 °C, 96 h
Thermal shock	-25 (0.5 h) ~ 70 °C (0.5 h), 5 cycles

{ } : Reference only

CODE FORMAT

No. of positions		8 positions								
Positions		0	1	2	3	4	5	6	7	
Code	Real code	4				●	●	●	●	
		2		●	●			●	●	
		1		●		●		●		●
	Complementary code	4	●	●	●	●				
		2	●	●			●	●		
		1	●		●		●		●	

● ... Contact closed

S-8000

ROTARY CODED SWITCHES

OUTLINE DIMENSIONS

Unless otherwise specified, tolerance: ± 0.3 (Unit: mm)

- S-8010 (Real code)
- S-8030 (Complementary code)

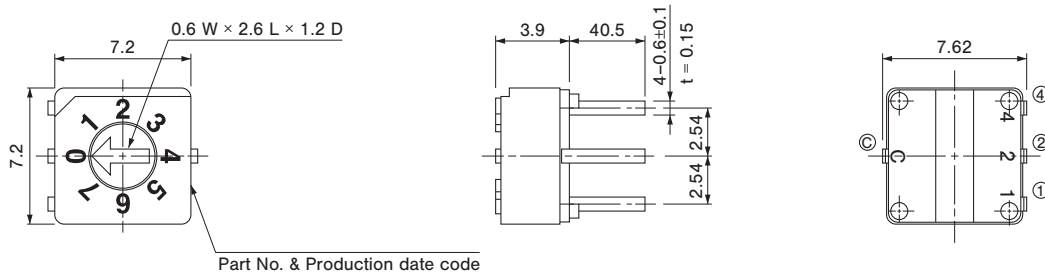

- S-8011 (Real code)
- S-8031 (Complementary code)

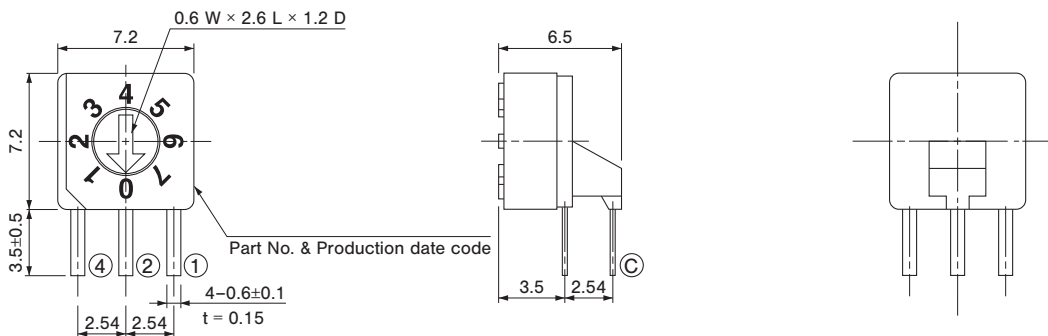

- S-8110 (Real code)
- S-8130 (Complementary code)

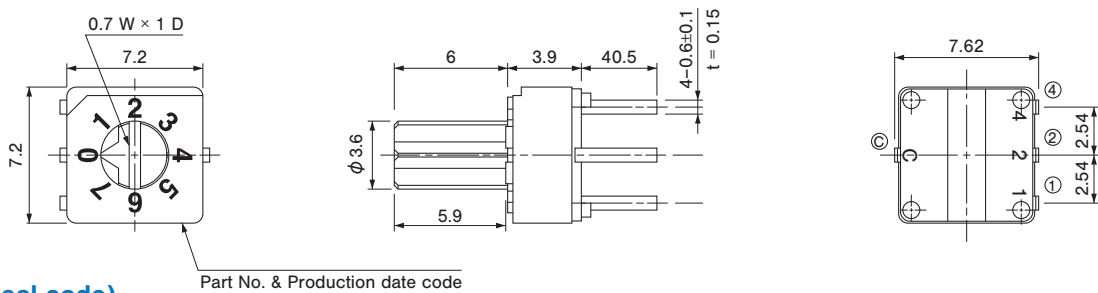

- S-8111 (Real code)
- S-8131 (Complementary code)

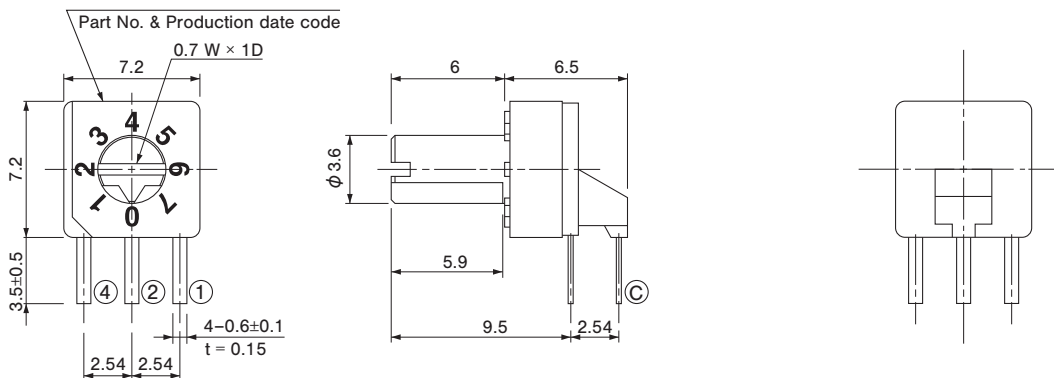

S-8000

ROTARY CODED SWITCHES

■ TERMINAL CONNECTION / P.C.B. THROUGH HOLE DIMENSIONS

(Unit: mm)

	Top setting	Side setting
Terminal pin layout (Bottom view)	<p>Real code Complementary code</p>	<p>Operating face of real code Operating face of complementary code</p>
P.C.B. dimensions (Bottom view)		

■ PACKAGING SPECIFICATIONS

<Tray packaging specifications>



- Tray version is packaged in 50 pcs. per tray. Orders will be accepted for units of 50 pcs., i. e., 50, 100, 150 pcs. etc.
- Tray version is boxed with 10 trays.

<Bulk pack specifications>

- The smallest unit of bulk pack in a plastic bag is 10 pcs. per pack.
Orders will be accepted for unit of minimum 10 pcs., i.e., 10, 20, 30 pcs., etc.
- Boxing of bulk in a plastic bag is performed with 50 pcs. (standard 100 pcs.) per box.

Looking for pricing, stock, or lifecycle information?

Click below to explore more details on WIN SOURCE:

-  [View S-8011 on WIN SOURCE](#)
-  [Nidec Copal Electronics Information](#)

Optimize Your Supply Chain with WIN SOURCE Solutions

-  Global Sourcing Solution
-  Obsolete Management
-  Cost Control Management
-  Shortage Management
-  Alternative Solution
-  Excess Inventory Management