

Freescale Semiconductor

 MPX2200
 Rev 13, 10/2008

200 kPa On-Chip Temperature Compensated Silicon Pressure Sensors

The MPX2200 series devices are silicon piezoresistive pressure sensor providing a highly accurate and linear voltage output directly proportional to the applied pressure. The sensor is a single monolithic silicon diaphragm with the strain gauge and a thin-film resistor network integrated on-chip. The chip is laser trimmed for precise span and offset calibration and temperature compensation. They are designed for use in applications such as pump/motor controllers, robotics, level indicators, medical diagnostics, pressure switching, barometers, altimeters, etc.

Features

- Temperature Compensated Over 0°C to +85°C
- $\pm 0.25\%$ Linearity (MPX2200D)
- Easy-to-Use Chip Carrier Package Options
- Absolute, Differential and Gauge Options

MPX2200 Series

0 to 200 kPa (0 to 29 psi)
 40 mV Full Scale Span
 (Typical)

Application Examples

- Pump/Motor Control
- Robotics
- Level Detectors
- Medical Diagnostics
- Pressure Switching
- Barometers
- Altimeters

ORDERING INFORMATION

Device Name	Package Options	Case No.	# of Ports			Pressure Type			Device Marking
			None	Single	Dual	Gauge	Differential	Absolute	
Unibody Package (MPX2200 Series)									
MPX2200A	Tray	344	•					•	MPX2200A
MPX2200D	Tray	344	•				•		MPX2200D
MPX2200DP	Tray	344C			•		•		MPX2200DP
MPX2200AP	Tray	344B		•				•	MPX2200AP
MPX2200GP	Tray	344B		•		•			MPX2200GP

UNIBODY PACKAGES



MPX2200A/D
 CASE 344-15



MPX2200AP/GP
 CASE 344B-01

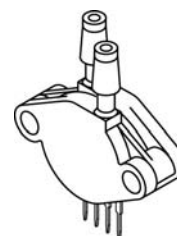

MPX2200DP
 CASE 344C-01

Operating Characteristics

Table 1. Operating Characteristics ($V_S = 10 V_{DC}$, $T_A = 25^\circ C$ unless otherwise noted, $P_1 > P_2$)

Characteristic	Symbol	Min	Typ	Max	Units
Differential Pressure Range ⁽¹⁾	P_{OP}	0	—	200	kPa
Supply Voltage ⁽²⁾	V_S	—	10	16	V_{DC}
Supply Current	I_O	—	6.0	—	mA _{dc}
Full Scale Span ⁽³⁾	V_{FSS}	38.5	40	41.5	mV
Offset ⁽⁴⁾	V_{OFF}	-1.0	—	1.0	mV
Sensitivity	$\Delta V/\Delta P$	—	0.2	—	mV/kPa
Linearity	MPX2200D Series MPX2200A Series	— -0.25 -1.0	— —	0.25 1.0	% V_{FSS}
Pressure Hysteresis(0 to 200 kPa)	—	—	± 0.1	—	% V_{FSS}
Temperature Hysteresis(- 40°C to +125°C)	—	—	± 0.5	—	% V_{FSS}
Temperature Coefficient of Full Scale Span	TCV_{FSS}	-1.0	—	1.0	% V_{FSS}
Temperature Coefficient of Offset	TCV_{OFF}	-1.0	—	1.0	mV
Input Impedance	Z_{IN}	1300	—	2500	Ω
Output Impedance	Z_{OUT}	1400	—	3000	Ω
Response Time ⁽⁵⁾ (10% to 90%)	t_R	—	1.0	—	ms
Warm-Up Time ⁽⁶⁾	—	—	20	—	ms
Offset Stability ⁽⁷⁾	—	—	± 0.5	—	% V_{FSS}

- 1.0 kPa (kiloPascal) equals 0.145 psi.
- Device is ratiometric within this specified excitation range. Operating the device above the specified excitation range may induce additional error due to device self-heating.
- Full Scale Span (V_{FSS}) is defined as the algebraic difference between the output voltage at full rated pressure and the output voltage at the minimum rated pressure.
- Offset (V_{OFF}) is defined as the output voltage at the minimum rated pressure.
- Response Time is defined as the time for the incremental change in the output to go from 10% to 90% of its final value when subjected to a specified step change in pressure.
- Warm-up Time is defined as the time required for the product to meet the specified output voltage after the pressure is stabilized.
- Offset stability is the product's output deviation when subjected to 1000 hours of Pulsed Pressure, Temperature Cycling with Bias Test.

Maximum Ratings

Table 2. Maximum Ratings⁽¹⁾

Rating	Max Value	Unit
Maximum Pressure (P1 > P2)	800	kPa
Storage Temperature	-40 to +125	°C
Operating Temperature	-40 to +125	°C

1. Exposure beyond the specified limits may cause permanent damage or degradation to the device.

Voltage Output versus Applied Differential

The output voltage of the differential or gauge sensor increases with increasing pressure applied to the pressure side (P1) relative to the vacuum side (P2). Similarly, output

voltage increases as increasing vacuum is applied to the vacuum side (P2) relative to the pressure side (P1).

Figure 1 shows a block diagram of the internal circuitry on the stand-alone pressure sensor chip.

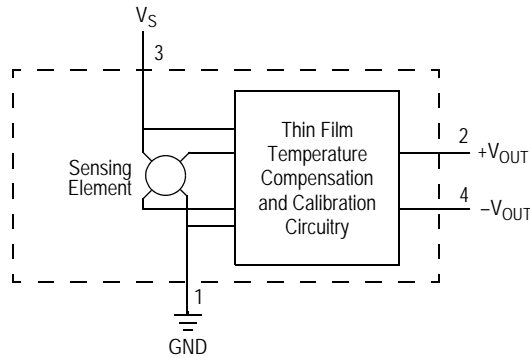

Figure 1. Temperature Compensated and Calibrated Pressure Sensor Schematic

On-Chip Temperature Compensation and Calibration

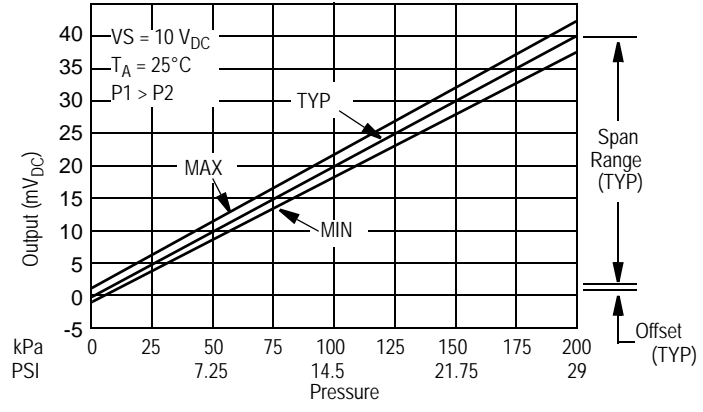

Figure 2. Output vs. Pressure Differential

Figure 2 shows the output characteristics of the MPX2200 series at 25°C. The output is directly proportional to the differential pressure and is essentially a straight line.

The effects of temperature on full scale span and offset are very small and are shown under Operating Characteristics.

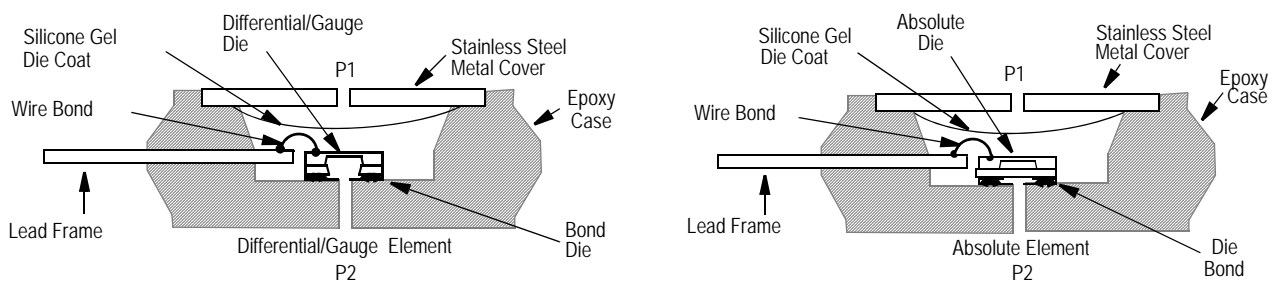

Figure 3. Cross Sectional Diagram (not to scale)

Figure 3 illustrates the differential/gauge die in the basic chip carrier (Case 344). A silicone gel isolates the die surface and wire bonds from the environment, while allowing the pressure signal to be transmitted to the silicon diaphragm.

The MPX2200 series pressure sensor operating characteristics and internal reliability and qualification tests are based on use of dry air as the pressure media. Media other than dry air may have adverse effects on sensor performance and long term reliability. Contact the factory for information regarding media compatibility in your application.

LINEARITY

Linearity refers to how well a transducer's output follows the equation: $V_{OUT} = V_{OFF} + \text{sensitivity} \times P$ over the operating pressure range. There are two basic methods for calculating nonlinearity: (1) end point straight line fit (see Figure 4) or (2) a least squares best line fit. While a least squares fit gives the "best case" linearity error (lower numerical value), the calculations required are burdensome.

Conversely, an end point fit will give the "worst case" error (often more desirable in error budget calculations) and the calculations are more straightforward for the user. Freescale's specified pressure sensor linearities are based on the end point straight line method measured at the midrange pressure.

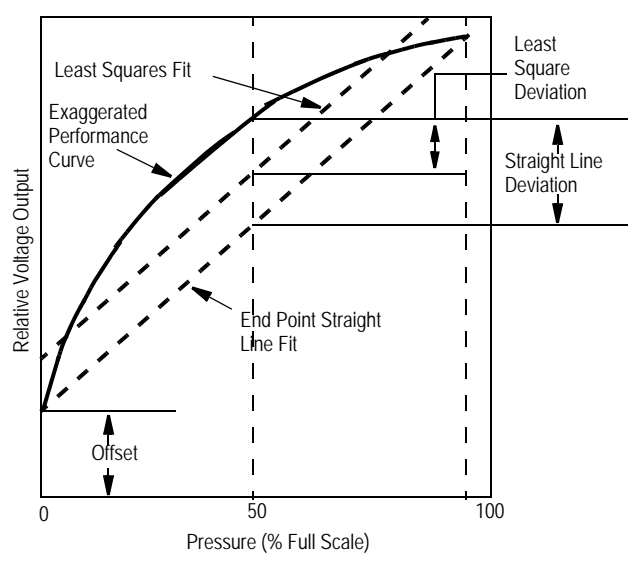

Figure 4. Linearity Specification Comparison

PRESSURE (P1)/VACUUM (P2) SIDE IDENTIFICATION TABLE

Freescale designates the two sides of the pressure sensor as the Pressure (P1) side and the Vacuum (P2) side. The Pressure (P1) side is the side containing silicone gel which isolates the die from the environment. The Freescale MPX pressure sensor is designed to operate with positive differential pressure applied, $P1 > P2$.

The Pressure (P1) side may be identified by using the following table.

Table 3. Pressure (P1) Side Delineation

Part Number	Case Type	Pressure (P1) Side Identifier
MPX2200D/A	344	Stainless Steel Cap
MPX2200DP	344C	Side with Part Marking
MPX2200GP/AP	344B	Side with Port Attached

PACKAGE DIMENSIONS

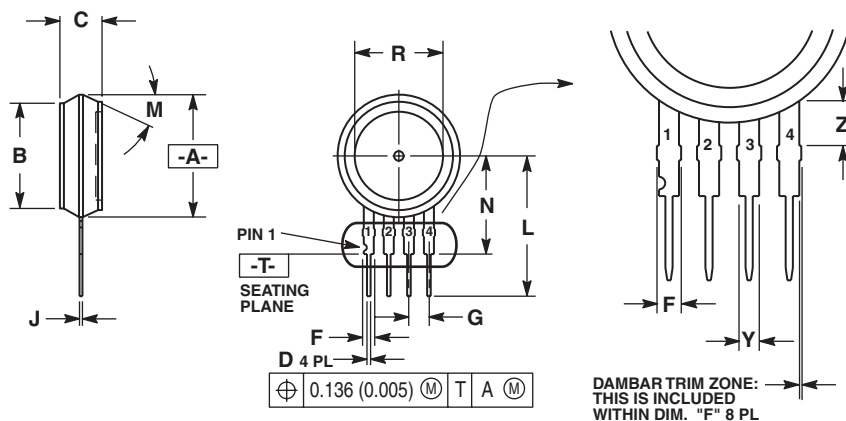

- NOTES:
1. DIMENSIONING AND TOLERANCING PER ASME Y14.5M, 1994.
 2. CONTROLLING DIMENSION: INCH.
 3. DIMENSION -A- IS INCLUSIVE OF THE MOLD STOP RING. MOLD STOP RING NOT TO EXCEED 16.00 (0.630).

DIM	INCHES		MILLIMETERS	
	MIN	MAX	MIN	MAX
A	0.595	0.630	15.11	16.00
B	0.514	0.534	13.06	13.56
C	0.200	0.220	5.08	5.59
D	0.016	0.020	0.41	0.51
F	0.048	0.064	1.22	1.63
G	0.100 BSC		2.54 BSC	
J	0.014	0.016	0.36	0.40
L	0.695	0.725	17.65	18.42
M	30° NOM		30° NOM	
N	0.475	0.495	12.07	12.57
R	0.430	0.450	10.92	11.43
Y	0.048	0.052	1.22	1.32
Z	0.106	0.118	2.68	3.00

CASE 344-15 ISSUE AA UNIBODY PACKAGE

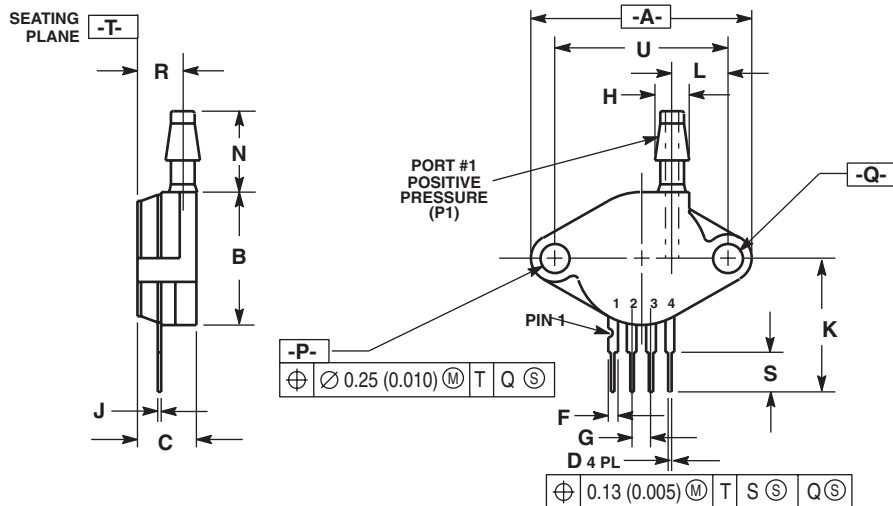

- NOTES:
1. DIMENSIONING AND TOLERANCING PER ANSI Y14.5M, 1982.
 2. CONTROLLING DIMENSION: INCH.

DIM	INCHES		MILLIMETERS	
	MIN	MAX	MIN	MAX
A	1.145	1.175	29.08	29.85
B	0.685	0.715	17.40	18.16
C	0.305	0.325	7.75	8.26
D	0.016	0.020	0.41	0.51
F	0.048	0.064	1.22	1.63
G	0.100 BSC		2.54 BSC	
H	0.182	0.194	4.62	4.93
J	0.014	0.016	0.36	0.41
K	0.695	0.725	17.65	18.42
L	0.290	0.300	7.37	7.62
N	0.420	0.440	10.67	11.18
P	0.153	0.159	3.89	4.04
Q	0.153	0.159	3.89	4.04
R	0.230	0.250	5.84	6.35
S	0.220	0.240	5.59	6.10
U	0.910 BSC		23.11 BSC	

CASE 344B-01 ISSUE B UNIBODY PACKAGE

PACKAGE DIMENSIONS

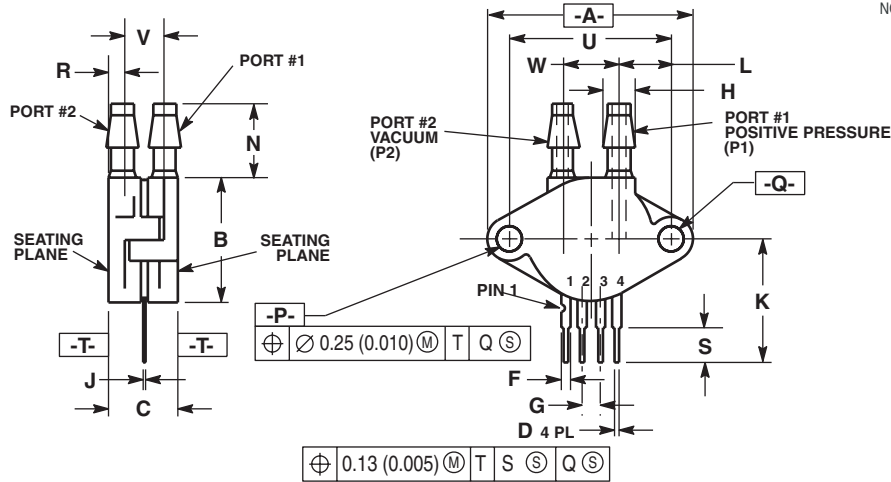

- NOTES:
1. DIMENSIONING AND TOLERANCING PER ANSI Y14.5M, 1982.
 2. CONTROLLING DIMENSION: INCH.

DIM	INCHES		MILLIMETERS	
	MIN	MAX	MIN	MAX
A	1.145	1.175	29.08	29.85
B	0.685	0.715	17.40	18.16
C	0.405	0.435	10.29	11.05
D	0.016	0.020	0.41	0.51
F	0.048	0.064	1.22	1.63
G	0.100 BSC		2.54 BSC	
H	0.182	0.194	4.62	4.93
J	0.014	0.016	0.36	0.41
K	0.695	0.725	17.65	18.42
L	0.290	0.300	7.37	7.62
N	0.420	0.440	10.67	11.18
P	0.153	0.159	3.89	4.04
Q	0.153	0.159	3.89	4.04
R	0.063	0.083	1.60	2.11
S	0.220	0.240	5.59	6.10
U	0.910 BSC		23.11 BSC	
V	0.248	0.278	6.30	7.06
W	0.310	0.330	7.87	8.38

CASE 344C-01 ISSUE B UNIBODY PACKAGE

How to Reach Us:

Home Page:

www.freescale.com

Web Support:

<http://www.freescale.com/support>

USA/Europe or Locations Not Listed:

Freescale Semiconductor, Inc.
Technical Information Center, EL516
2100 East Elliot Road
Tempe, Arizona 85284
1-800-521-6274 or +1-480-768-2130
www.freescale.com/support

Europe, Middle East, and Africa:

Freescale Halbleiter Deutschland GmbH
Technical Information Center
Schatzbogen 7
81829 Muenchen, Germany
+44 1296 380 456 (English)
+46 8 52200080 (English)
+49 89 92103 559 (German)
+33 1 69 35 48 48 (French)
www.freescale.com/support

Japan:

Freescale Semiconductor Japan Ltd.
Headquarters
ARCO Tower 15F
1-8-1, Shimo-Meguro, Meguro-ku,
Tokyo 153-0064
Japan
0120 191014 or +81 3 5437 9125
support.japan@freescale.com

Asia/Pacific:

Freescale Semiconductor China Ltd.
Exchange Building 23F
No. 118 Jianguo Road
Chaoyang District
Beijing 100022
China
+86 010 5879 8000
support.asia@freescale.com

For Literature Requests Only:

Freescale Semiconductor Literature Distribution Center
P.O. Box 5405
Denver, Colorado 80217
1-800-441-2447 or +1-303-675-2140
Fax: +1-303-675-2150
LDCForFreescaleSemiconductor@hibbertgroup.com

Information in this document is provided solely to enable system and software implementers to use Freescale Semiconductor products. There are no express or implied copyright licenses granted hereunder to design or fabricate any integrated circuits or integrated circuits based on the information in this document.

Freescale Semiconductor reserves the right to make changes without further notice to any products herein. Freescale Semiconductor makes no warranty, representation or guarantee regarding the suitability of its products for any particular purpose, nor does Freescale Semiconductor assume any liability arising out of the application or use of any product or circuit, and specifically disclaims any and all liability, including without limitation consequential or incidental damages. "Typical" parameters that may be provided in Freescale Semiconductor data sheets and/or specifications can and do vary in different applications and actual performance may vary over time. All operating parameters, including "Typicals", must be validated for each customer application by customer's technical experts. Freescale Semiconductor does not convey any license under its patent rights nor the rights of others. Freescale Semiconductor products are not designed, intended, or authorized for use as components in systems intended for surgical implant into the body, or other applications intended to support or sustain life, or for any other application in which the failure of the Freescale Semiconductor product could create a situation where personal injury or death may occur. Should Buyer purchase or use Freescale Semiconductor products for any such unintended or unauthorized application, Buyer shall indemnify and hold Freescale Semiconductor and its officers, employees, subsidiaries, affiliates, and distributors harmless against all claims, costs, damages, and expenses, and reasonable attorney fees arising out of, directly or indirectly, any claim of personal injury or death associated with such unintended or unauthorized use, even if such claim alleges that Freescale Semiconductor was negligent regarding the design or manufacture of the part.

Freescale™ and the Freescale logo are trademarks of Freescale Semiconductor, Inc. All other product or service names are the property of their respective owners.

© Freescale Semiconductor, Inc. 2008. All rights reserved.

Looking for pricing, stock, or lifecycle information?

Click below to explore more details on WIN SOURCE:

 [View MPX2200D on WIN SOURCE](#)

 [NXP / Nexperia Information](#)

Optimize Your Supply Chain with WIN SOURCE Solutions

-  Global Sourcing Solution
-  Obsolete Management
-  Cost Control Management
-  Shortage Management
-  Alternative Solution
-  Excess Inventory Management