



**THE DATASHEET OF
MAX13030EETE+**



Click [here](#) to ask about the production status of specific part numbers.

MAX13030E–MAX13035E 6-Channel High-Speed Logic-Level Translators

General Description

The MAX13030E–MAX13035E 6-channel, bidirectional level translators provide the level shifting necessary for 100Mbps data transfer in multivoltage systems. The MAX13030E–MAX13035E are ideally suited for memory-card level translation, as well as generic level translation in systems with six channels. Externally applied voltages, V_{CC} and V_L , set the logic levels on either side of the device. Logic signals present on the V_L side of the device appear as a higher voltage logic signal on the V_{CC} side of the device and vice versa. The MAX13035E features a CLK_RET output that returns the same clock signal applied to the CLK_VL input.

The MAX13030E–MAX13035E operate at full speed with external drivers that source as little as 4mA output current. Each I/O channel is pulled up to V_{CC} or V_L by an internal 30 μ A current source, allowing the MAX13030E–MAX13035E to be driven by either push-pull or open-drain drivers.

The MAX13030E–MAX13034E feature an enable (EN) input that places the device into a low-power shutdown mode when driven low. The MAX13030E–MAX13035E features an automatic shutdown mode that disables the part when V_{CC} is less than V_L . The state of I/O V_{CC} and I/O V_L during shutdown is chosen by selecting the appropriate part version (see *Ordering Information/Selector Guide*).

The MAX13030E–MAX13035E accept V_{CC} voltages from +2.2V to +3.6V and V_L voltages from +1.62V to +3.2V, making them ideal for data transfer between low-voltage ASIC/PLDs and higher voltage systems. The MAX13030E–MAX13035E are available in 16-bump UCSP (2mm x 2mm) and 16-pin TQFN (4mm x 4mm) packages, and operate over the extended -40°C to +85°C temperature range.

Applications

- SD Card Level Translation
- MiniSD Card Level Translation
- MMC Level Translation
- Transflash Level Translation
- Memory Stick Card Level Translation

Ordering Information/Selector Guide

PART	PIN-PACKAGE	I/O V_L STATE DURING SHUTDOWN	I/O V_{CC} STATE DURING SHUTDOWN	PKG CODE
MAX13030EEBE+	16 UCSP	High impedance	High impedance	B16+1
MAX13030EETE+	16 TQFN-EP**	High impedance	High impedance	T1644+4
MAX13035EETE/V+T	16 TQFN-EP**	High impedance	High impedance	T1644+4

Note: All devices are specified over the -40°C to +85°C operating temperature range.

+Denotes a lead-free package.

**EP = Exposed paddle.

Features

- Compatible with 4mA Input Drivers or Larger
- 100Mbps Guaranteed Data Rate
- Six Bidirectional Channels
- Clock Return Output (MAX13035E)
- Enable Input (MAX13030E–MAX13034E)
- ± 15 kV ESD Protection on I/O V_{CC} Lines
- $+1.62\text{V} \leq V_L \leq +3.2\text{V}$ and $+2.2\text{V} \leq V_{CC} \leq +3.6\text{V}$ Supply Voltage Range
- Lead-Free, 16-Bump UCSP (2mm x 2mm) and 16-pin TQFN (4mm x 4mm) Packages

Typical Operating Circuits

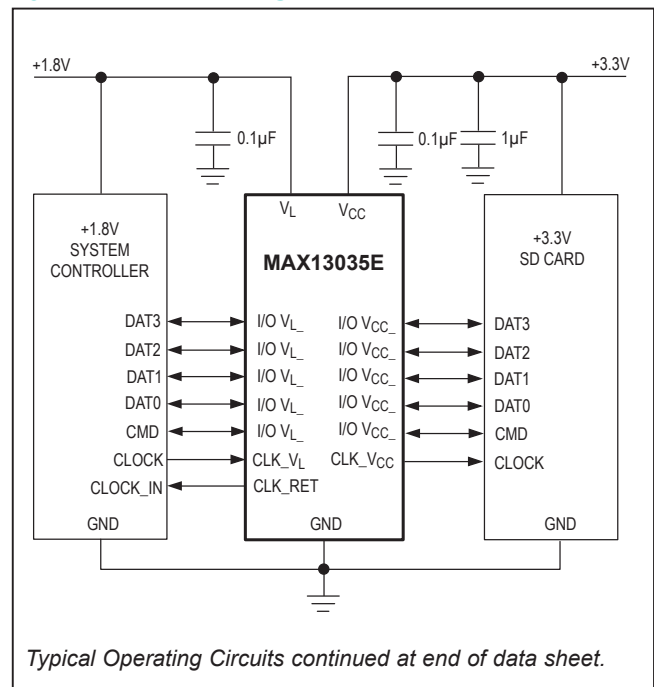

Functional Diagram and Pin Configurations appear at end of data sheet.

Absolute Maximum Ratings

(All voltages referenced to GND.)

V_{CC}, V_L	-0.3V to +4V
I/O V_{CC}, CLK_V_{CC}	-0.3V to ($V_{CC} + 0.3V$)
I/O V_L, CLK_V_L, CLK_RET	-0.3V to ($V_L + 0.3V$)
EN	-0.3V to +4V
Short-Circuit Duration I/O $V_L, I/O V_{CC}, CLK_V_{CC}, CLK_V_L, CLK_RET$ to GND	Continuous
Continuous Power Dissipation ($T_A = +70^\circ C$)	
16-Bump UCSP (derate 8.2mW/ $^\circ C$)	660mW
16-Pin TQFN (derate 25.0mW/ $^\circ C$)	2000mW

Operating Temperature Range	-40°C to +85°C
Storage Temperature Range	-65°C to +150°C
Junction Temperature	+150°C
Bump Temperature (soldering)	+235°C
Lead Temperature (soldering, 10s)	+300°C

Stresses beyond those listed under "Absolute Maximum Ratings" may cause permanent damage to the device. These are stress ratings only, and functional operation of the device at these or any other conditions beyond those indicated in the operational sections of the specifications is not implied. Exposure to absolute maximum rating conditions for extended periods may affect device reliability.

Package Information

16 UCSP	
Package Code	B16+1
Outline Number	21-0101
Land Pattern Number	
THERMAL RESISTANCE, MULTI-LAYER BOARD:	
Junction to Ambient (θ_{JA})	121.3°C/W
Junction to Case (θ_{JC})	

16 TQFN	
Package Code	T1644+4/T1644+4A
Outline Number	21-0139
Land Pattern Number	90-0070
THERMAL RESISTANCE, MULTI-LAYER BOARD:	
Junction to Ambient (θ_{JA})	40°C/W
Junction to Case (θ_{JC})	6°C/W

For the latest package outline information and land patterns (footprints), go to www.maximintegrated.com/packages. Note that a "+", "#", or "-" in the package code indicates RoHS status only. Package drawings may show a different suffix character, but the drawing pertains to the package regardless of RoHS status.

Package thermal resistances were obtained using the method described in JEDEC specification JESD51-7, using a four-layer board. For detailed information on package thermal considerations, refer to www.maximintegrated.com/thermal-tutorial.

Electrical Characteristics

($V_{CC} = +2.2V$ to $+3.6V$, $V_L = +1.62V$ to $+3.2V$, $EN = V_L$, $T_A = -40^{\circ}C$ to $+85^{\circ}C$, unless otherwise noted. Typical values are at $V_{CC} = +3.3V$, $V_L = +1.8V$ and $T_A = +25^{\circ}C$.) (Notes 1, 2)

PARAMETER	SYMBOL	CONDITIONS	MIN	TYP	MAX	UNITS
POWER SUPPLIES						
V_L Supply Range	V_L	(Note 2)	1.62		3.20	V
V_{CC} Supply Range	V_{CC}		2.2		3.6	V
Supply Current from V_{CC}	I_{QVCC}	$I/O V_{CC_} = V_{CC}$, $I/O V_{L_} = V_L$		16	25	μA
		$I/O V_{CC_} = V_{CC}$, $I/O V_{L_} = V_L$ (MAX13035EETE/V+T)		16	35	
Supply Current from V_L	I_{QVL}	$I/O V_{CC_} = V_{CC}$, $I/O V_{L_} = V_L$		6	10	μA
		$I/O V_{CC_} = V_{CC}$, $I/O V_{L_} = V_L$ (MAX13035EETE/V+T)		6	15	
V_{CC} Shutdown Supply Current	$I_{SHDN-VCC}$	$T_A = +25^{\circ}C$, $EN = GND$ or $V_L > V_{CC} + 0.7V$, MAX13030E–MAX13034E		2	4	μA
		$T_A = +25^{\circ}C$, $V_L > V_{CC} + 0.7V$, MAX13035E,		2	4	
		$T_A = +25^{\circ}C$, $V_L > V_{CC} + 0.7V$, (MAX13035EETE/V+T)		2	6	
V_L Shutdown Supply Current	$I_{SHDN-VL}$	$T_A = +25^{\circ}C$, $EN = GND$ or $V_L > V_{CC} + 0.7V$, MAX13030E–MAX13034E		0.1	4	μA
		$T_A = +25^{\circ}C$, $V_L > V_{CC} + 0.7V$, MAX13035E		0.1	4	
		$T_A = +25^{\circ}C$, $V_L > V_{CC} + 0.7V$, (MAX13035EETE/V+T)		2	6	
$I/O V_{CC_}$, $I/O V_{L_}$, CLK_V_{CC} Tri-State Leakage Current	I_{LEAK}	$T_A = +25^{\circ}C$, $EN = GND$ or $V_L > V_{CC} + 0.7V$		0.1	2	μA
EN Input Leakage Current	I_{LEAK_EN}	$T_A = +25^{\circ}C$, MAX13030E–MAX13034E			1	μA
$V_L - V_{CC}$ Shutdown Threshold High	V_{TH_H}	V_{CC} rising	-0.2	$0.05V_L$	0.7	V
		V_{CC} rising, (MAX13035EETE/V+T)	-0.2	$0.05V_L$	0.85	
$V_L - V_{CC}$ Shutdown Threshold Low	V_{TH_L}	V_{CC} falling	-0.2	$0.1V_L$	0.7	V
		V_{CC} falling, (MAX13035EETE/V+T)	-0.2	$0.1V_L$	0.85	
$I/O V_{CC_}$ Pulldown Resistance During Shutdown	$R_{VCC_PD_SD}$	$EN = GND$, MAX13032E/MAX13034E	10	16.5	23	k Ω
$I/O V_{CC_}$ Pullup Resistance During Shutdown	$R_{VCC_PU_SD}$	$EN = GND$, MAX13031E	10	16.5	23	k Ω
$I/O V_{L_}$ Pulldown Resistance During Shutdown	$R_{VL_PD_SD}$	$EN = GND$, MAX13033E/MAX13034E	10	16.5	23	k Ω

Electrical Characteristics (continued)

($V_{CC} = +2.2V$ to $+3.6V$, $V_L = +1.62V$ to $+3.2V$, $EN = V_L$, $T_A = -40^\circ C$ to $+85^\circ C$, unless otherwise noted. Typical values are at $V_{CC} = +3.3V$, $V_L = +1.8V$ and $T_A = +25^\circ C$.) (Notes 1, 2)

PARAMETER	SYMBOL	CONDITIONS	MIN	TYP	MAX	UNITS
I/O V_L , CLK_ V_L , CLK_RET Pullup Resistance During Shutdown	$R_{VL_PU_SD}$	($V_L > V_{CC} + 0.7V$), MAX13035E	45	75	105	k Ω
		($V_L > V_{CC} + 0.7V$), (MAX13035EETE/V+T)	35	75	115	
I/O V_L , CLK_ V_L , CLK_RET Pullup Current	R_{VL_PU}	$EN = V_{CC}$ or V_L , I/O $V_L = GND$	20			μA
		$EN = V_{CC}$ or V_L , I/O $V_L = GND$, (MAX13035EETE/V+T)	12			
I/O V_{CC} , CLK_ V_{CC} Pullup Current	R_{VCC_PU}	$EN = V_{CC}$ or V_L , I/O $V_{CC} = GND$	20			μA
		$EN = V_{CC}$ or V_L , I/O $V_{CC} = GND$, (MAX13035EETE/V+T)	15			
I/O V_L to I/O V_{CC} DC Resistance	R_{IOVL_IOVCC}	(Note 3)		3		k Ω
ESD PROTECTION (Note 3)						
I/O V_{CC} , CLK_ V_{CC}		Human Body Model, $C_{VCC} = 1.0\mu F$		± 15		kV
		IEC 61000-4-2 Air-Gap Discharge, $C_{VCC} = 1.0\mu F$		± 12		
		IEC 61000-4-2 Contact Discharge, $C_{VCC} = 1.0\mu F$		± 8		
LOGIC-LEVEL THRESHOLDS						
I/O V_L , CLK_ V_L Input-Voltage High Threshold	V_{IHL}	(Note 4)			$V_L - 0.2$	V
I/O V_L , CLK_ V_L Input-Voltage Low Threshold	V_{ILL}	(Note 4)	0.15			V
I/O V_{CC} , CLK_ V_{CC} Input-Voltage High Threshold	V_{IHC}	(Note 4)			$V_{CC} - 0.4$	V
I/O V_{CC} , CLK_ V_{CC} Input-Voltage Low Threshold	V_{ILC}	(Note 4)	0.2			V
EN Input-Voltage High Threshold	V_{IH}	MAX13030E–MAX13034E			$V_L - 0.4$	V
EN Input-Voltage Low	V_{IL}	MAX13030E–MAX13034E	0.4			V
I/O V_L , CLK_ V_L , CLK_RET Output-Voltage High	V_{OHL}	I/O V_L , CLK_ V_L , CLK_RET source current = $20\mu A$, I/O $V_{CC} \geq V_{CC} - 0.4V$	$2/3 V_L$			V
I/O V_L , CLK_ V_L , CLK_RET Output-Voltage Low	V_{OLL}	I/O V_L , CLK_ V_L , CLK_RET sink current = $20\mu A$, I/O $V_{CC} \leq 0.2V$		$1/3 V_L$		V
I/O V_{CC} , CLK_ V_{CC} Output-Voltage High	V_{OHC}	I/O V_{CC} , CLK_ V_{CC} source current = $20\mu A$, I/O $V_L \geq V_L - 0.2V$	$2/3 V_{CC}$			V
I/O V_{CC} , CLK_ V_{CC} Output-Voltage Low	V_{OLC}	I/O V_{CC} , CLK_ V_{CC} sink current = $20\mu A$, I/O $V_L \leq 0.15V$		$1/3 V_{CC}$		V

Electrical Characteristics (continued)

($V_{CC} = +2.2V$ to $+3.6V$, $V_L = +1.62V$ to $+3.2V$, $EN = V_L$, $T_A = -40^{\circ}C$ to $+85^{\circ}C$, unless otherwise noted. Typical values are at $V_{CC} = +3.3V$, $V_L = +1.8V$ and $T_A = +25^{\circ}C$.) (Notes 1, 2)

PARAMETER	SYMBOL	CONDITIONS	MIN	TYP	MAX	UNITS
RISE/FALL TIME ACCELERATOR STAGE (Note 3)						
Accelerator Pulse Duration		On falling edge		3		ns
		On rising edge		3		
V_L -Output-Accelerator Source Impedance		$V_L = 1.62V$		11		Ω
		$V_L = 3.2V$		6		
V_{CC} -Output-Accelerator Source Impedance		$V_{CC} = 2.2V$		9		Ω
		$V_{CC} = 3.6V$		8		
V_L -Output-Accelerator Sink Impedance		$V_L = 1.62V$		9		Ω
		$V_L = 3.2V$		8		
V_{CC} -Output-Accelerator Sink Impedance		$V_{CC} = 2.2V$		10		Ω
		$V_{CC} = 3.6V$		9		

Timing Characteristics

($V_{CC} = +2.2V$ to $+3.6V$, $V_L = +1.62V$ to $+3.2V$, $C_{I/OVL} \leq 15pF$, $C_{I/OVCC} \leq 15pF$, $R_{SOURCE} = 150\Omega$, $EN = V_L$, I/O V_L to I/O V_{CC} rise/fall time = 3ns, $T_A = -40^{\circ}C$ to $+85^{\circ}C$, unless otherwise noted. Typical values are at $V_{CC} = +3.3V$, $V_L = 1.8V$ and $T_A = +25^{\circ}C$.) (Note 1 and Note 5)

PARAMETER	SYMBOL	CONDITIONS	MIN	TYP	MAX	UNITS
I/O V_{CC} , CLK_ V_{CC} Rise Time	t_{RVCC}	$R_S = 150\Omega$, $C_{I/OVCC} = 10pF$, $C_{CLK_VCC} = 10pF$, push-pull drivers (Figure 1)			2.5	ns
I/O V_{CC} , CLK_ V_{CC} Fall Time	t_{FVCC}	$R_S = 150\Omega$, $C_{I/OVCC} = 10pF$, $C_{CLK_VCC} = 10pF$ (Figures 1, 2)			2.5	ns
I/O V_L , CLK_ V_L Rise Time	t_{RVL}	$R_S = 150\Omega$, $C_{I/OVL} = 15pF$, $C_{CLK_VL} = 15pF$, push-pull drivers (Figure 3)			2.5	ns
I/O V_L , CLK_ V_L Fall Time	t_{FVL}	$R_S = 150\Omega$, $C_{I/OVL} = 15pF$, $C_{CLK_VL} = 15pF$ (Figures 3, 4)			2.5	ns
Propagation Delay (Driving I/O V_L , CLK_ V_L)	$t_{PVL-VCC}$	$R_S = 150\Omega$, $C_{I/OVCC} = 10pF$, $C_{CLK_VCC} = 10pF$, push-pull drivers (Figure 1)			6.5	ns
		$R_S = 150\Omega$, $C_{I/OVCC} = 10pF$, $C_{CLK_VCC} = 10pF$, push-pull drivers (Figure 1) (MAX13035EETE/V+T)			8	
Propagation Delay (Driving I/O V_{CC} , CLK_ V_{CC})	$t_{PVCC-VL}$	$R_S = 150\Omega$, $C_{I/OVL} = 15pF$, $C_{CLK_VL} = 15pF$, push-pull drivers (Figure 3)			6.5	ns
		$R_S = 150\Omega$, $C_{I/OVL} = 15pF$, $C_{CLK_VL} = 15pF$, push-pull drivers (Figure 3) (MAX13035EETE/V+T)			8	
Channel-to-Channel Skew	t_{SKEW}	$R_S = 150\Omega$, $C_{I/OVCC} = 10pF$, $C_{I/OVL} = 15pF$			0.8	ns
Propagation Delay from I/O V_L to I/O V_{CC} after EN	t_{EN-VCC}	$R_{LOAD} = 1M\Omega$, $C_{I/OVCC} = 10pF$ (Figure 5) (MAX13030E–MAX13034E)		5		μs

Timing Characteristics (continued)

(V_{CC} = +2.2V to +3.6V, V_L = +1.62V to +3.2V, $C_{I/OVL} \leq 15\text{pF}$, $C_{I/OVCC} \leq 15\text{pF}$, $R_{SOURCE} = 150\Omega$, $EN = V_L$, I/O V_L to I/O V_{CC} rise/fall time = 3ns, $T_A = -40^\circ\text{C}$ to $+85^\circ\text{C}$, unless otherwise noted. Typical values are at $V_{CC} = +3.3\text{V}$, $V_L = 1.8\text{V}$ and $T_A = +25^\circ\text{C}$.) (Note 1 and Note 5)

PARAMETER	SYMBOL	CONDITIONS	MIN	TYP	MAX	UNITS
Propagation Delay from I/O V_{CC} to I/O V_L after EN	t_{EN-VL}	$R_{LOAD} = 1\text{M}\Omega$, $C_{I/OVL} = 15\text{pF}$ (Figure 5) (MAX13030E–MAX13034E)		5		μs
Maximum Data Rate		Push-pull operation, $R_{SOURCE} = 150\Omega$, $C_{I/OVCC} = 10\text{pF}$, $C_{I/OVL} = 15\text{pF}$, $C_{CLK_VCC} = 10\text{pF}$, $C_{CLK_VL} = 15\text{pF}$	100			Mbps

Note 1: All units are 100% production tested at $T_A = +25^\circ\text{C}$. Limits over the operating temperature range are guaranteed by design and not production tested.

Note 2: V_L must be less than or equal to $V_{CC} - 0.2\text{V}$ during normal operation. However, V_L can be greater than V_{CC} during startup and shutdown conditions and the part will not latch-up or be damaged.

Note 3: Guaranteed by design.

Note 4: Input thresholds are referenced to the boost circuit.

Note 5: MAX13035EETE/V+T is guaranteed by design.

Typical Operating Characteristics

($V_{CC} = 3.3V$, $V_L = 1.8V$, $C_L = 15pF$, $R_{SOURCE} = 150\Omega$, data rate = 100Mbps, push-pull driver, $T_A = +25^\circ C$, unless otherwise noted.)

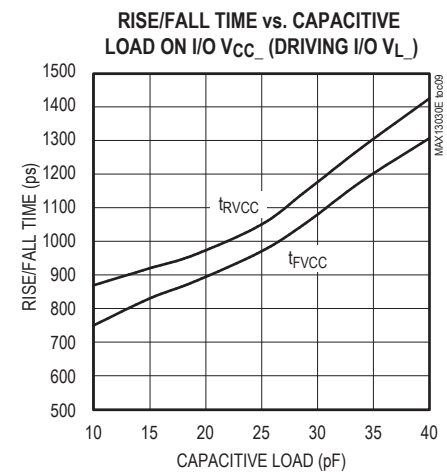
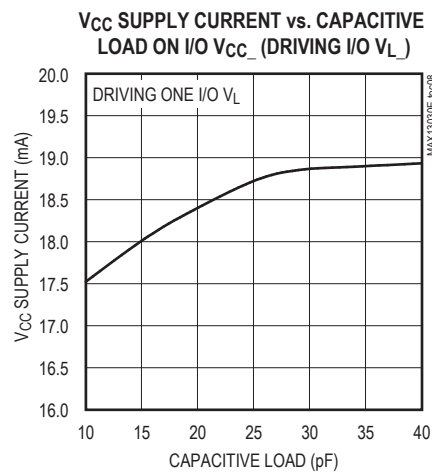
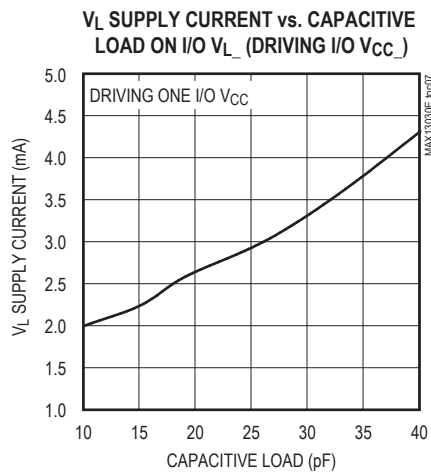
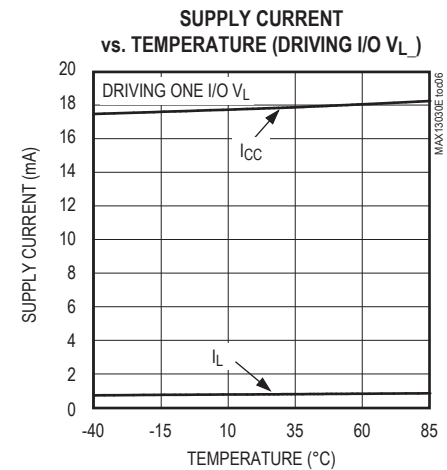
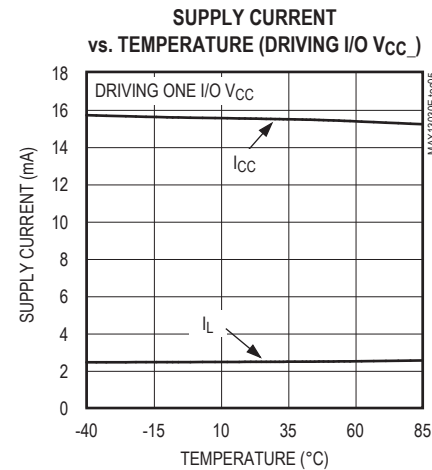
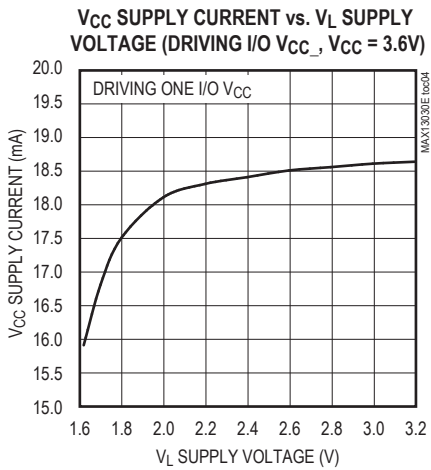
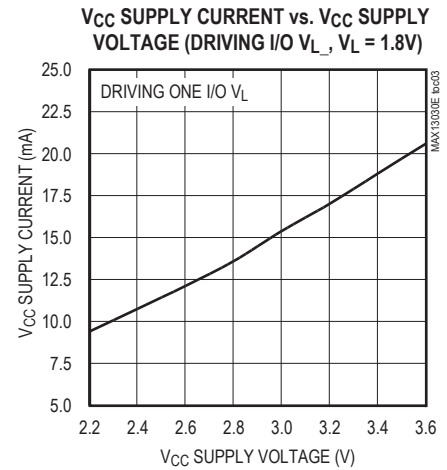
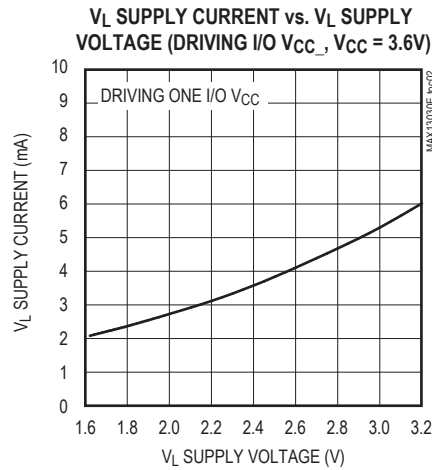
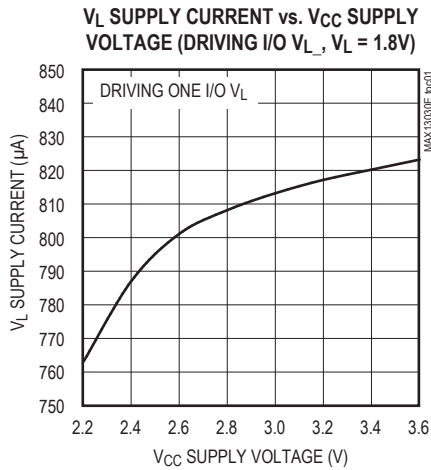

Typical Operating Characteristics (continued)

($V_{CC} = 3.3V$, $V_L = 1.8V$, $C_L = 15pF$, $R_{SOURCE} = 150\Omega$, data rate = 100Mbps, push-pull driver, $T_A = +25^\circ C$, unless otherwise noted.)

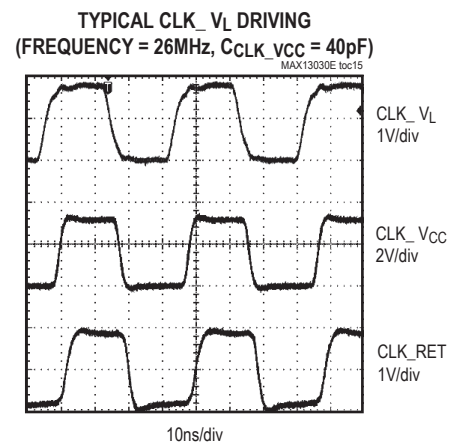
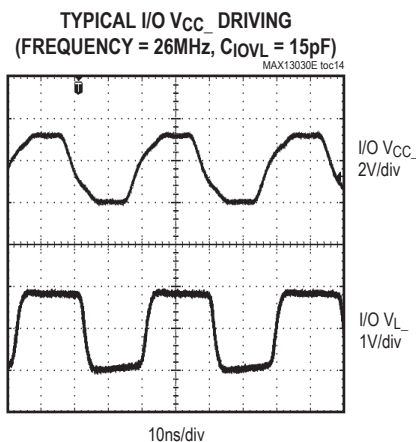
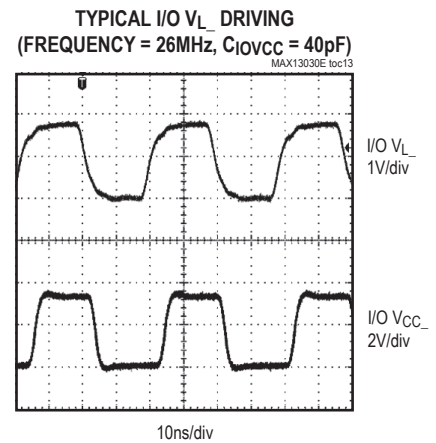
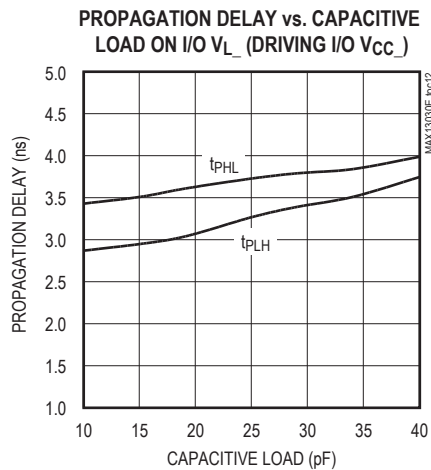
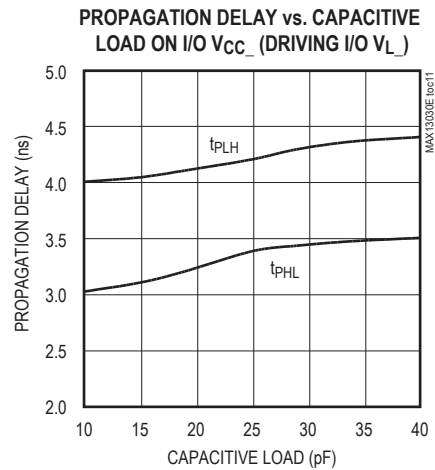
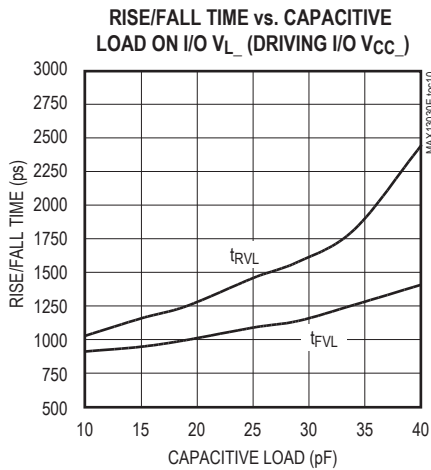

Pin Description

PIN				NAME	FUNCTION
MAX13030E–MAX13034E		MAX13035E			
UCSP	TQFN	UCSP	TQFN		
A1	4	A1	4	I/O V_{L3}	Input/Output 3. Referenced to V_L .
A2	6	A2	6	I/O V_{CC3}	Input/Output 3. Referenced to V_{CC} .
A3	7	A3	7	I/O V_{CC4}	Input/Output 4. Referenced to V_{CC} .
A4	9	A4	9	I/O V_{L4}	Input/Output 4. Referenced to V_L .
B1	3	B1	3	I/O V_{L2}	Input/Output 2. Referenced to V_L .
B2	5	B2	5	I/O V_{CC2}	Input/Output 2. Referenced to V_{CC} .
B3	8	B3	8	I/O V_{CC5}	Input/Output 5. Referenced to V_{CC} .
B4	10	B4	10	I/O V_{L5}	Input/Output 5. Referenced to V_L .
C1	2	C1	2	V_L	Logic-Supply Voltage, +1.62V to +3.2V. Bypass V_L to GND with a 0.1 μ F capacitor placed as close as possible to the device.
C2	16	C2	16	V_{CC}	Power-Supply Voltage, +2.2V to +3.6V. Bypass V_{CC} to GND with a 0.1 μ F ceramic capacitor. For full ESD protection, connect a 1 μ F ceramic capacitor from V_{CC} to GND as close as possible to the V_{CC} input.
C3	13	C3	13	GND	Ground
C4	11	—	—	EN	Enable Input. Drive EN to GND for shutdown mode, or drive EN to V_L or V_{CC} for normal operation.
D1	1	D1	1	I/O V_{L1}	Input/Output 1. Referenced to V_L .
D2	15	D2	15	I/O V_{CC1}	Input/Output 1. Referenced to V_{CC} .
D3	14	—	—	I/O V_{CC6}	Input/Output 6. Referenced to V_{CC} .
D4	12	—	—	I/O V_{L6}	Input/Output 6. Referenced to V_L .
—	—	C4	11	CLK_RET	Clock Return Output. CLK_RET is the returned signal of a clock applied to CLK_ V_L . CLK_RET is referenced to V_L .
—	—	D3	14	CLK_ V_{CC}	Translator Channel for a Clock Applied to V_{CC}
—	—	D4	12	CLK_ V_L	Translator Channel for a Clock Applied to V_L
—	EP	—	EP	EP	Exposed Paddle. Connect exposed paddle to GND.

Test Circuits/Timing Diagrams

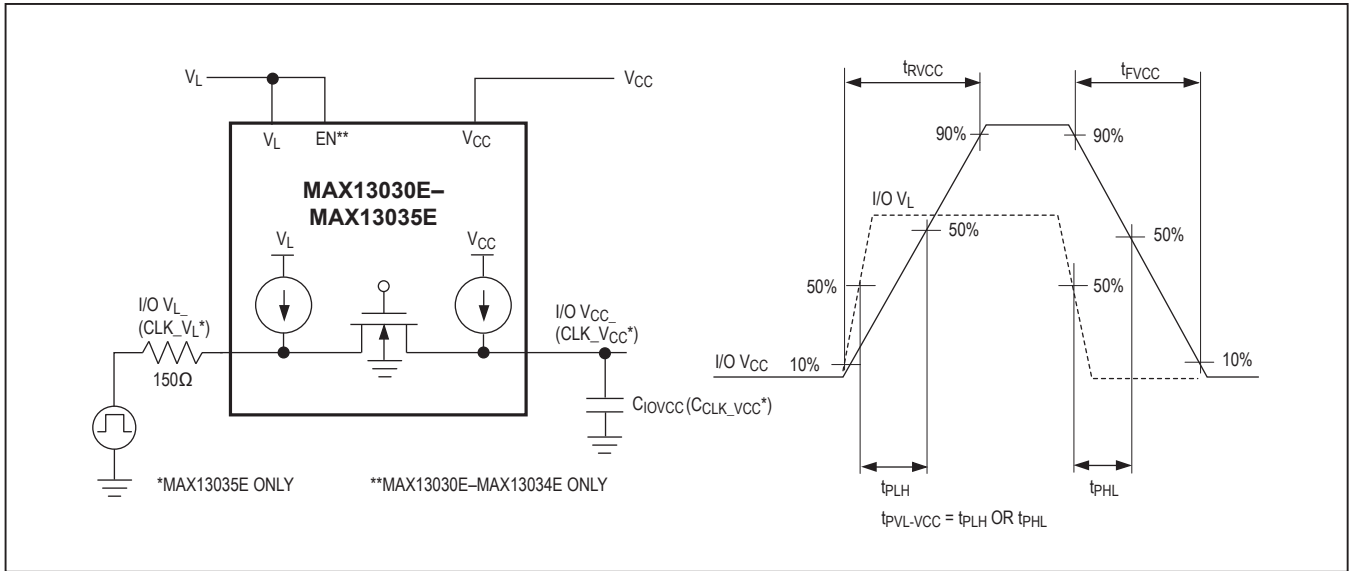

Figure 1. Push-Pull Driving I/O VL_ Test Circuit and Timing

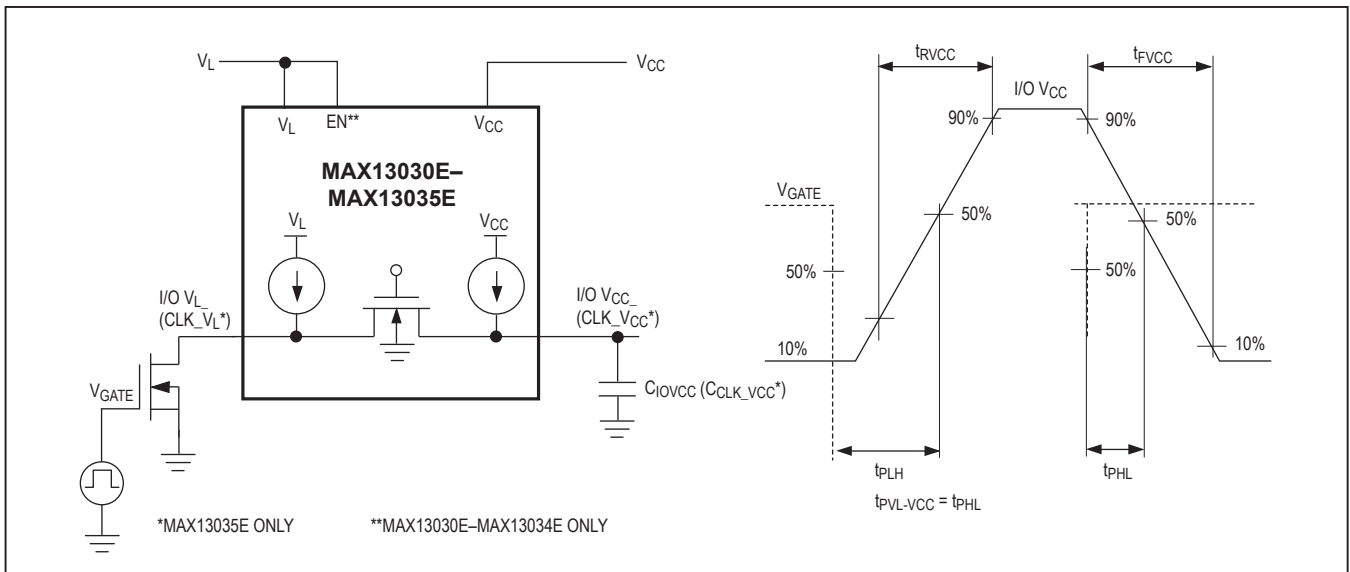

Figure 2. Open-Drain Driving I/O VL_ Test Circuit and Timing

Test Circuits/Timing Diagrams (continued)

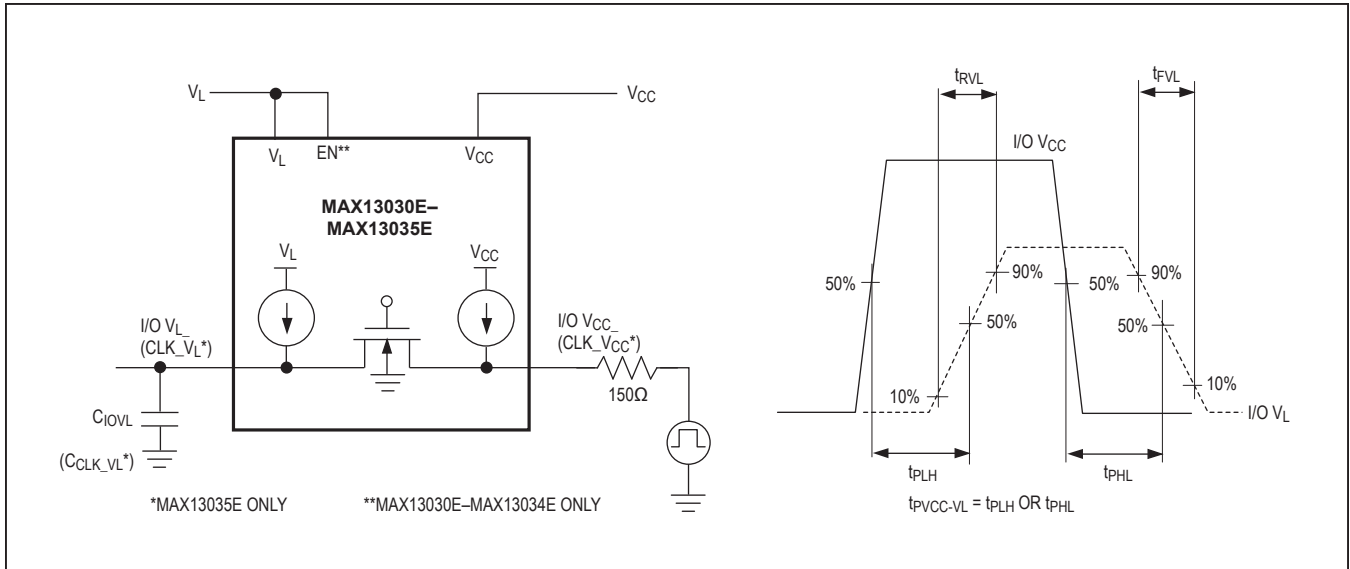

Figure 3. Push-Pull Driving I/O VCC_ Test Circuit and Timing

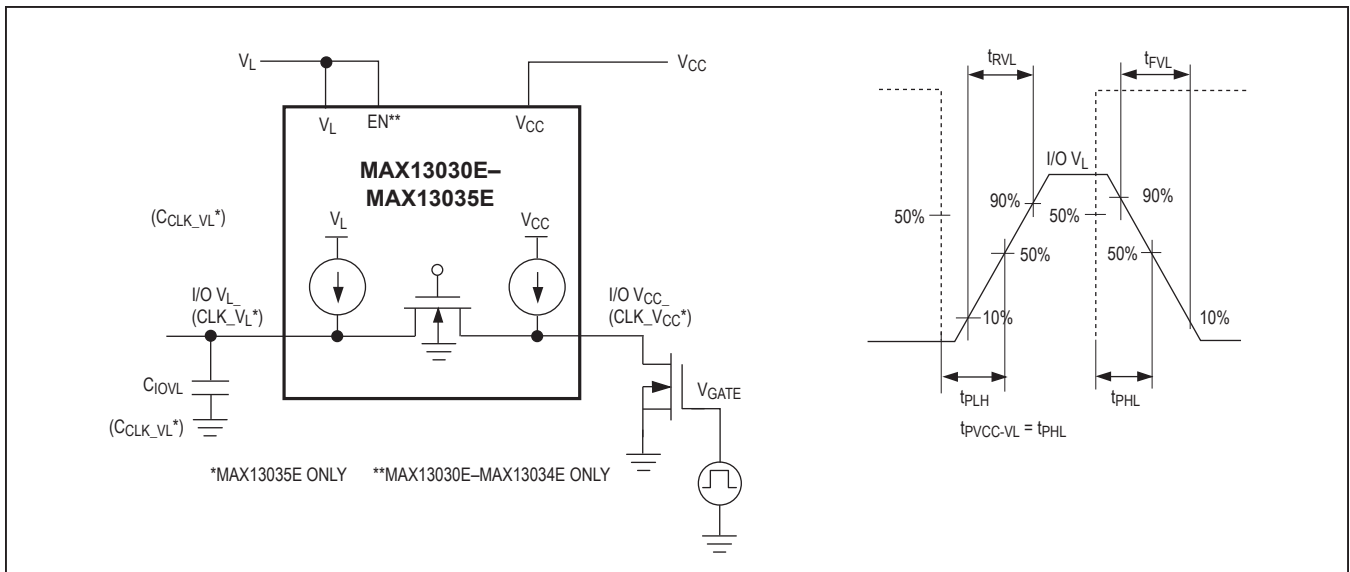

Figure 4. Open-Drain Driving I/O VCC_ Test Circuit and Timing

Test Circuits/Timing Diagrams (continued)

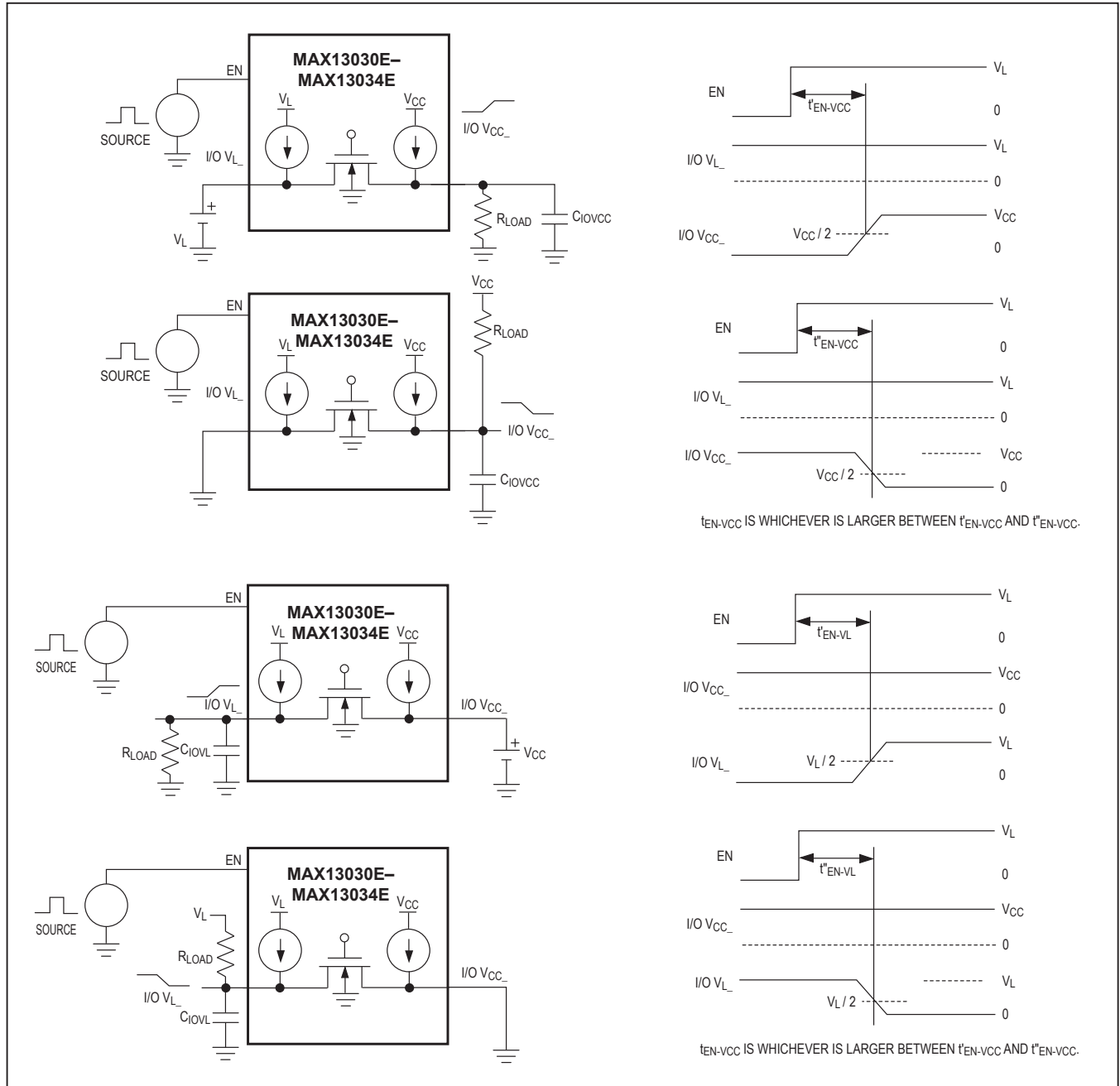

Figure 5. Enable Test Circuit and Timing

Detailed Description

The MAX13030E–MAX13035E 6-channel, bidirectional level translators provide the level shifting necessary for 100Mbps data transfer in multivoltage systems. The MAX13030E–MAX13035E are ideally suited for memory card level translation, as well as generic level translation in systems with six channels. Externally applied voltages, V_{CC} and V_L , set the logic levels on either side of the device. Logic signals present on the V_L side of the device appear as a higher voltage logic signal on the V_{CC} side of the device, and vice versa. The MAX13035E features a CLK_RET output that returns the same clock signal applied to the CLK_ V_L input.

The MAX13030E–MAX13035E operate at full speed with external drivers that source as little as 4mA output current. Each I/O channel is pulled up to V_{CC} or V_L by an internal 30 μ A current source, allowing the MAX13030E–MAX13035E to be driven by either push-pull or open-drain drivers.

The MAX13030E–MAX13034E feature an enable (EN) input that places the device into a low-power shutdown mode when driven low. The MAX13030E–MAX13035E features an automatic shutdown mode that disables the part when V_{CC} is less than V_L . The state of I/O V_{CC} and I/O V_L during shutdown is chosen by selecting the appropriate part version (see *Ordering Information/Selector Guide*).

The MAX13030E–MAX13035E accept V_{CC} voltages from +2.2V to +3.6V and V_L voltages from +1.62V to +3.2V.

Level Translation

For proper operation, ensure that $+2.2V \leq V_{CC} \leq +3.6V$, and $+1.62V \leq V_L \leq V_{CC} - 0.2V$. When power is supplied to V_L while V_{CC} is either missing or less than V_L , the MAX13030E–MAX13035E automatically enters a low-power mode. In addition, the MAX13030E–MAX13034E enters a low-power mode if EN = 0V. This allows V_{CC} to be disconnected and still have a known state on I/O V_L . The maximum data rate depends heavily on the load capacitance (see the *Typical Operating Characteristics Rise/Fall Times*), output impedance of the driver, and the operating voltage range.

Input Driver Requirements

The MAX13030E–MAX13035E architecture is based on an nMOS pass gate and output accelerator stages (see Figure 6). Output accelerator stages are always in tri-state mode except when there is a transition on any of the translators on the input side, either I/O V_L , CLK_ V_L , I/O V_{CC} , or CLK_ V_{CC} . A short pulse is then generated during which the output accelerator stages become active and charge/discharge the capacitances at the I/Os. Due to its architecture, both input stages become active during

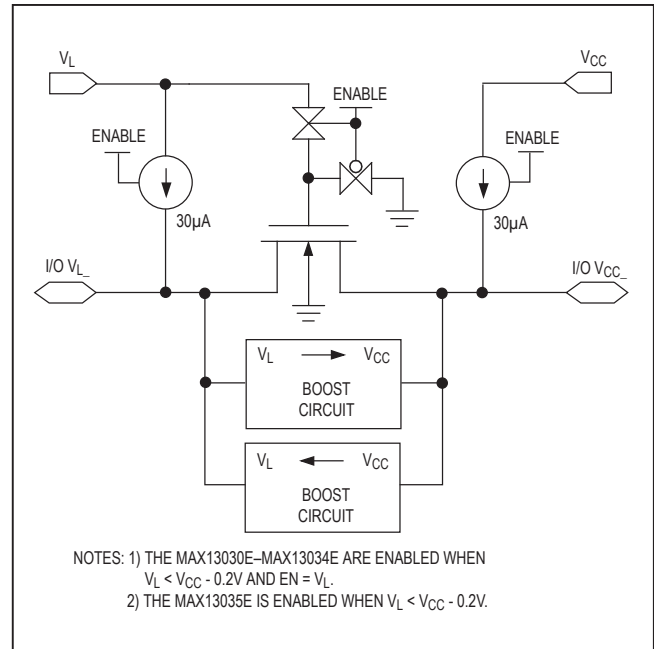

Figure 6. Simplified Functional Diagram for One I/O Line

the one-shot pulse. This can lead to some current feeding into the external source that is driving the translator. However, this behavior helps to speed up the transition on the driven side.

The MAX13030E–MAX13035E have internal current sources capable of sourcing 30 μ A to pullup the I/O lines. These internal pullup current sources allow the inputs to be driven with open-drain drivers, as well as push-pull drivers. It is not recommended to use external pullup resistors on the I/O lines. The architecture of the MAX13030E–MAX13035E permit either side to be driven with a minimum of 4mA drivers or larger.

Output Load Requirements

The MAX13030E–MAX13035E I/O are designed to drive CMOS inputs. Do not load the I/O lines with a resistive load less than 25k Ω and do not place an RC circuit at the input of these devices to slow down the edges. If a slower rise/fall time is required, refer to the MAX3000E/MAX3001E logic-level translator datasheet. For I²C level translation, refer to the MAX3372E–MAX3379E/MAX3390E–MAX3393E datasheet.

Shutdown Mode

The MAX13030E–MAX13034E feature an enable (EN) input that places the device into a low-power shutdown mode when driven low. The MAX13030E–MAX13035E features an automatic shutdown mode that disables the part when V_{CC} is missing or less than V_L .

Clock Return (CLK_RET)

The MAX13035E features a CLK_RET output that returns the clock signal applied to CLK_V_L. CLK_V_L and CLK_V_{CC} are identical to the other I/O channels, the only difference being that CLK_V_{CC} is internally tied to the V_{CC} side of CLK_RET (see the *Functional Diagram*).

Application Information

Layout Recommendations

Use standard high-speed layout practices when laying out a board with the MAX13030E–MAX13035E. For example, to minimize line coupling, place all other signal lines not connected to the MAX13030E–MAX13035E at least 1x the substrate height of the PCB away from the input and output lines of the MAX13030E–MAX13035E.

Power-Supply Decoupling

To reduce ripple and the chance of introducing data errors, bypass V_L and V_{CC} to ground with 0.1µF ceramic capacitors. Place all capacitors as close as possible to the power-supply inputs. For full ESD protection, bypass V_{CC} with a 1µF ceramic capacitor located as close as possible to the V_{CC} input.

Unidirectional vs. Bidirectional Level Translator

The MAX13030E–MAX13035E bidirectional level translators can operate as a unidirectional device to translate signals without inversion. These devices provide the smallest solution (UCSP package) for unidirectional level translation without inversion.

Use with External Pullup/Pulldown Resistors

Due to the architecture of the MAX13030E–MAX13035E, it is not recommended to use external pullup or pulldown resistors on the bus. In certain applications, the use of external pullup or pulldown resistors is desired to have a known bus state when there is no active driver on the bus. For example, this may happen when interfacing to a memory card slot with no memory card inserted. The MAX13030E–MAX13035E include internal pullup current sources that set the bus state when the device is enabled. In shutdown mode, the state of I/O V_{CC} and I/O V_L is dependent on the selected part version (see *Ordering Information/Selector Guide* for further information).

Open-Drain Signaling

The MAX13030E–MAX13035E are designed to pass open-drain as well as CMOS push-pull signals. When used with open-drain signaling, the rise time is dominated by the interaction of the internal pullup current source and the parasitic load capacitance. The MAX13030E–MAX13035E include internal rise time accelerators to speed up transitions, eliminating any need for external pullup resistors.

SD Card Detection

SD, MiniSD, MMC and similar types of cards provide detection of a card through a pullup resistor on one of the DAT lines, or by use of a mechanical switch. This pullup resistor is internal to the memory card itself. The MAX13030E–MAX13035E only support detection of a memory card through a mechanical switch, and it is recommended that the internal resistor for card detection be switched off by the command interface. For example, when using SD cards, the command SET_CLR_CARD_DETECT (ACMD42) disables this resistor.

UCSP Applications Information

For the latest application details on UCSP construction, dimensions, tape carrier information, PCB techniques, bump-pad layout, and recommended reflow temperature profiles, as well as the latest information on reliability testing results, go to Maxim's web site at www.maximintegrated.com/ucsp to find the Application Note: *UCSP – A Wafer-Level Chip-Scale Package*.

Chip Information

PROCESS: BiCMOS

Functional Diagram

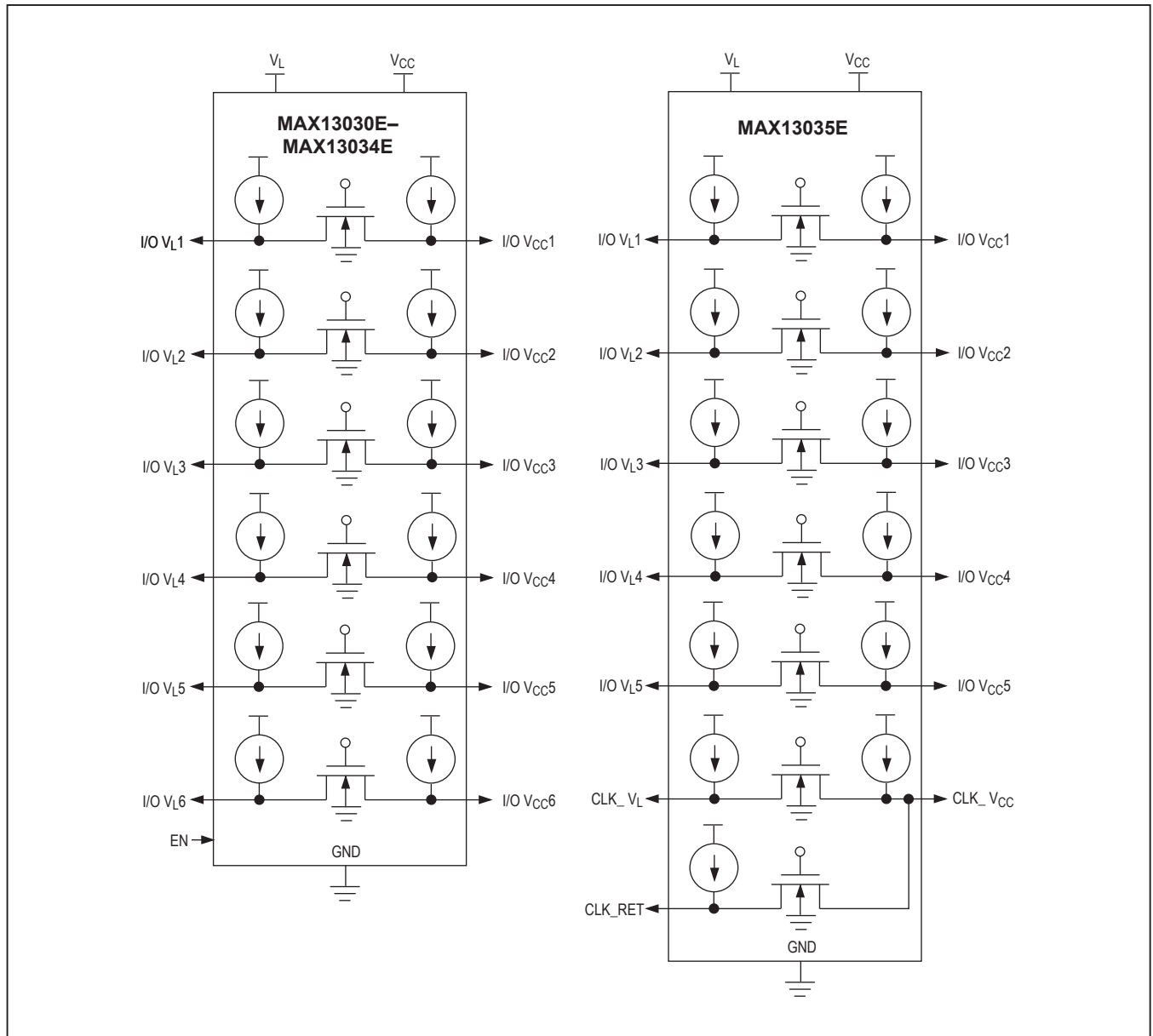

Pin Configurations

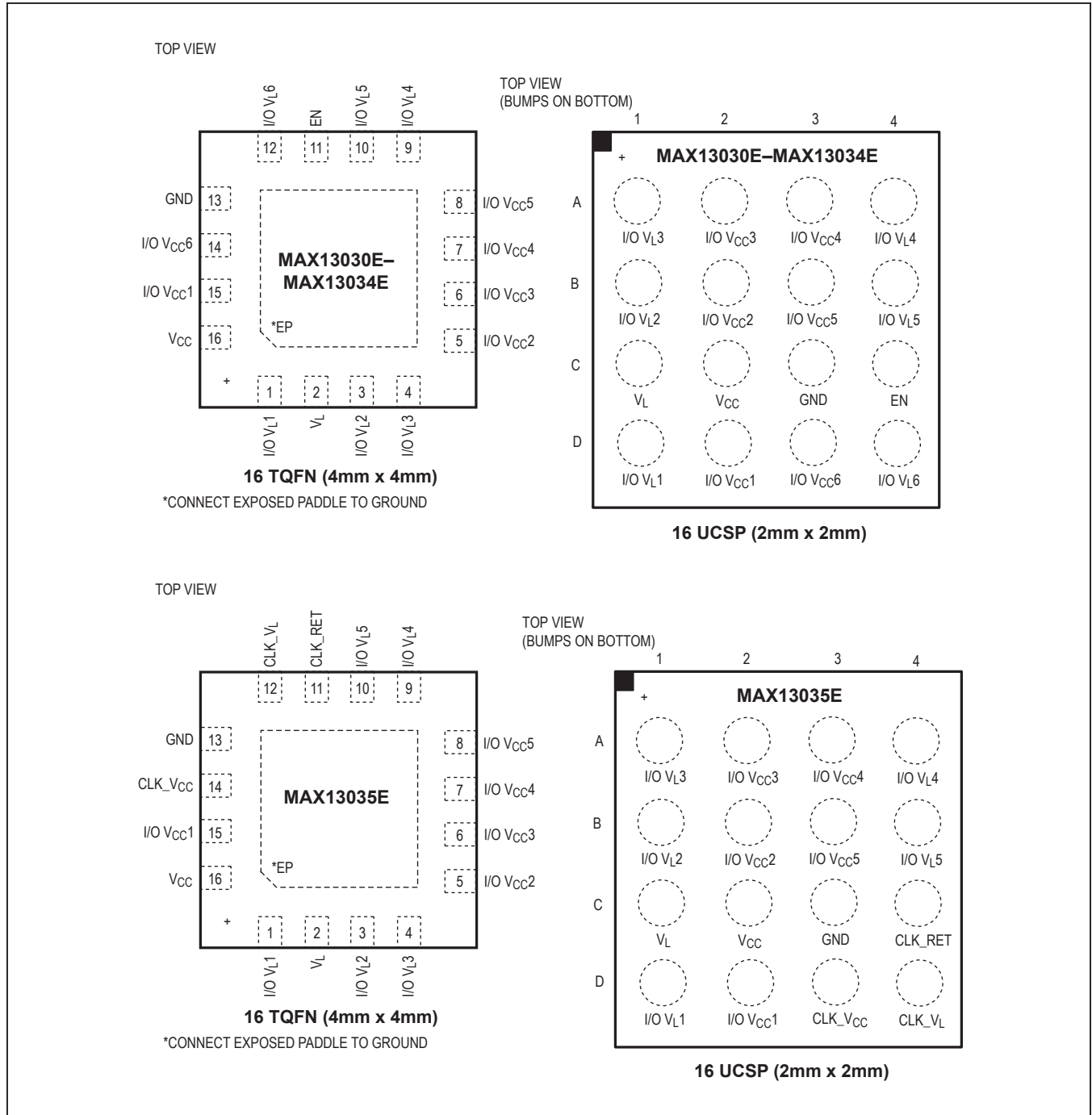

Typical Operating Circuits (continued)

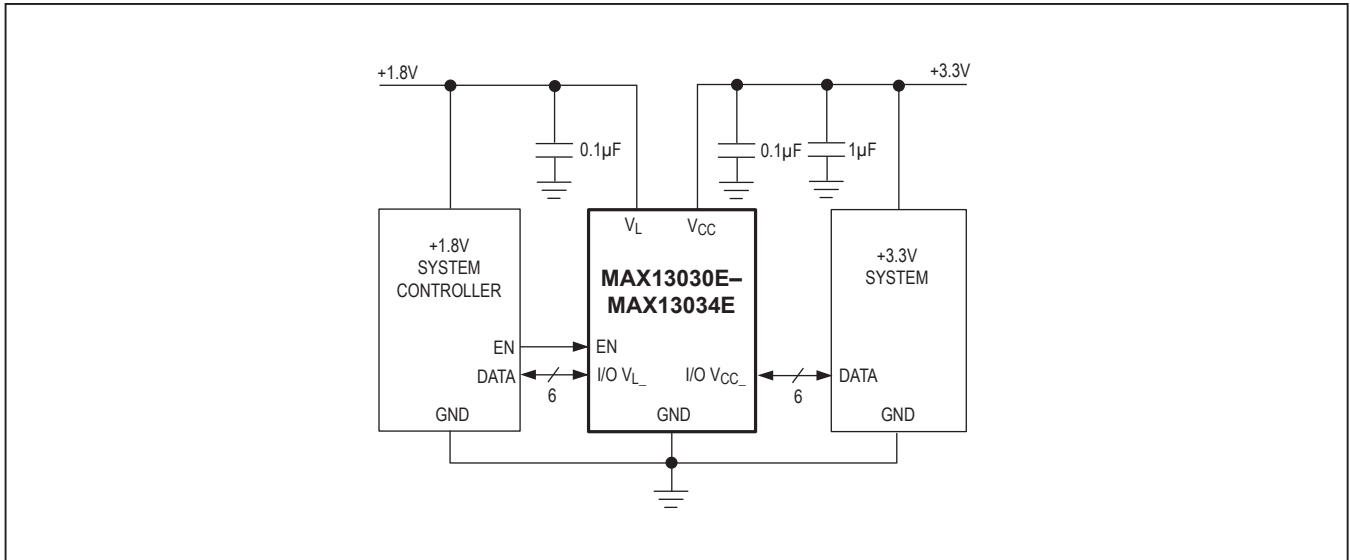

Ordering Information/Selector Guide

PART	PIN-PACKAGE	I/O V _L _ STATE DURING SHUTDOWN	I/O V _{CC} _ STATE DURING SHUTDOWN	PKG CODE
MAX13031 EEBE+*	16 UCSP	High impedance	16.5kΩ to V _{CC}	B16+1
MAX13031EETE+*	16 TQFN-EP**	High impedance	16.5kΩ to V _{CC}	T1644+4
MAX13032 EEBE+	16 UCSP	High impedance	16.5kΩ to GND	B16+1
MAX13032EETE+	16 TQFN-EP**	High impedance	16.5kΩ to GND	T1644+4
MAX13033 EEBE+*	16 UCSP	16.5kΩ to GND	High impedance	B16+1
MAX13033EETE+*	16 TQFN-EP**	16.5kΩ to GND	High impedance	T1644+4
MAX13034 EEBE+*	16 UCSP	16.5kΩ to GND	16.5kΩ to GND	B16+1
MAX13034EETE+*	16 TQFN-EP**	16.5kΩ to GND	16.5kΩ to GND	T1644+4
MAX13035 EEBE+	16 UCSP	75kΩ to V _L	High impedance	B16+1
MAX13035EETE+	16 TQFN-EP**	75kΩ to V _L	High impedance	T1644+4

Note: All devices are specified over the -40°C to +85°C operating temperature range.

+Denotes a lead-free package.

**EP = Exposed paddle.

Revision History

REVISION NUMBER	REVISION DATE	DESCRIPTION	PAGES CHANGED
0	1/07	Initial release	—
1	12/20	The datasheet is updated to reflect new part MAX13035EETE/V, which reflects compliance to automotive standard. <i>Ordering Information/Selector Guide</i> , <i>Electrical Characteristics</i> table, and <i>Package information</i> are updated.	1, 2–4, 17
2	2/21	Updated <i>Timing Characteristics</i>	5, 6

For pricing, delivery, and ordering information, please visit Maxim Integrated's online storefront at <https://www.maximintegrated.com/en/storefront/storefront.html>.

Maxim Integrated cannot assume responsibility for use of any circuitry other than circuitry entirely embodied in a Maxim Integrated product. No circuit patent licenses are implied. Maxim Integrated reserves the right to change the circuitry and specifications without notice at any time. The parametric values (min and max limits) shown in the *Electrical Characteristics* table are guaranteed. Other parametric values quoted in this data sheet are provided for guidance.

Looking for pricing, stock, or lifecycle information?

Click below to explore more details on WIN SOURCE:

- ⊖ [View MAX13030EETE+ on WIN SOURCE](#)
- ⊖ [Maxim Integrated Information](#)

Optimize Your Supply Chain with WIN SOURCE Solutions

- ✓ Global Sourcing Solution
- ✓ Obsolete Management
- ✓ Cost Control Management
- ✓ Shortage Management
- ✓ Alternative Solution
- ✓ Excess Inventory Management