



**THE DATASHEET OF
LAUNCHXL-F28069M**



LAUNCHXL-F28069M Overview

Contents

1	Introduction	2
2	Kit Contents.....	3
3	Installation	3
4	Getting Started With the LAUNCHXL-F28069M.....	4
5	Hardware Configuration.....	5
6	LAUNCHXL-F28069M Hardware	9
7	Frequently Asked Questions (FAQ).....	22
8	References	23

List of Figures

1	LAUNCHXL-F28069M Board Overview	3
2	USB Serial Port	5
3	Boot Switch Orientation	6
4	LAUNCHXL-F28069_B_1400922 Block Diagram Schematic	11
5	LAUNCHXL-F28069_B_1400922 USB to JTAG Schematic	12
6	LAUNCHXL-F28069_B_1400922 F28069_A Schematic	13
7	LAUNCHXL-F28069_B_1400922 F28069_B Schematic	14
8	LAUNCHXL-F28069_B_1400922 Connector Schematic	15
9	LAUNCHXL-F28069_B_1400922 Logic Choice Schematic	16
10	LAUNCHXL-F28069_B_1400922 Power Schematic	17
11	Top Silk	18
12	Top Copper	18
13	Inner Copper 1.....	18
14	Inner Copper 2.....	18
15	Bottom Silk	18
16	Bottom Copper.....	18

List of Tables

1	Serial Connectivity.....	6
2	S1 Boot Mode Settings	7
3	F28069M LaunchPad Pin Out and Pin Mux Options - J1, J3.....	9
4	F28069M LaunchPad Pin Out and Pin Mux Options - J4, J2.....	9
5	F28069M LaunchPad Pin Out and Pin Mux Options - J5, J7	10
6	F28069M LaunchPad Pin Out and Pin Mux Options - J8, J6	10
7	LAUNCHXL-F28069M Bill of Materials	19

Trademarks

C2000, Piccolo, LaunchPad, Code Composer Studio are trademarks of Texas Instruments. Windows is a registered trademark of Microsoft Corporation in the United States and/or other countries. All other trademarks are the property of their respective owners.

1 Introduction

The C2000™ Piccolo™ LaunchPad™, LAUNCHXL-F28069M, is a complete low-cost development board for the Texas Instruments Piccolo F2806x devices and InstaSPIN technology. The LAUNCHXL-F28069M kit features all the hardware and software necessary to develop applications based on the F2806x microprocessor. The LaunchPad is based on the superset F28069M device, and easily allows users to migrate to lower cost F2806x devices once the design needs are known. It offers an on-board JTAG emulation tool allowing direct interface to a PC for easy programming, debugging, and evaluation. In addition to JTAG emulation, the USB interface provides a universal asynchronous receiver/transmitter (UART) serial connection from the F2806x device to the host PC.

Users can download an unrestricted version of Code Composer Studio™ IDE to write, download, and debug applications on the LAUNCHXL-F28069M board. The debugger is unobtrusive, allowing the user to run an application at full speed with hardware breakpoints and single stepping available while consuming no extra hardware resources.

As shown in [Figure 1](#), the LAUNCHXL-F28069M C2000 LaunchPad features include:

- USB debugging and programming interface via a high-speed galvanically isolated XDS100v2 debug probe featuring a USB/UART connection
- Superset F28069M device that allows applications to easily migrate to lower cost devices
- Two user LEDs
- Device reset pushbutton
- Easily accessible device pins for debugging purposes or as sockets for adding customized extension boards
- InstaSPIN library in ROM, allowing implementation of InstaSPIN-MOTION and InstaSPIN-FOC solutions
- Dual 5 V quadrature encoder interfaces
- CAN Interface with integrated transceiver
- Boot selection switches

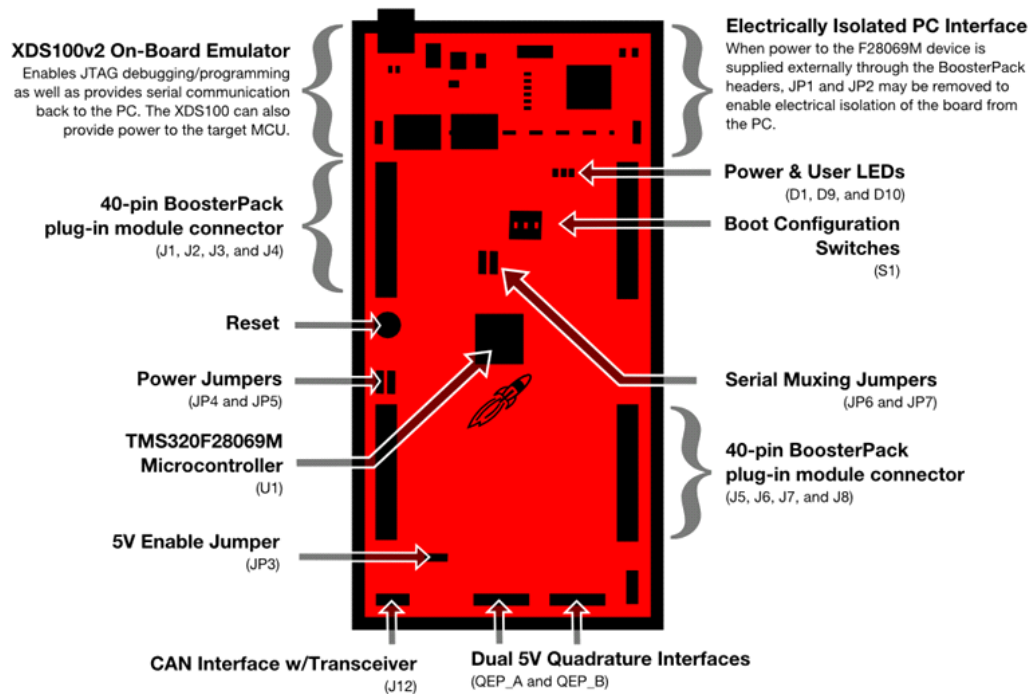

Figure 1. LAUNCHXL-F28069M Board Overview

2 Kit Contents

The LAUNCHXL-F28069M LaunchPad experimenter kit includes the following items:

- C2000 LaunchPad Board (LAUNCHXL-F28069M)
- Mini USB-B Cable, 0.5m
- Quick Start Guide

2.1 Revisions

The first and only production released of the LAUNCHXL-F28069M in 2014 was revision 1.2.

All Revisions:

- Resistor R7 in the oscillator circuit is incorrectly placed or should not be installed. This resistor may impact startup time or robustness of the clocking circuit over the full operating range of the MCU or different physical layouts of this circuit. The probability is low that this resistor will have any impact on the functionality of this EVM as is not intended to be operated outside of Standard Temperature and Pressure in a lab or prototype environment. Do not use this circuit as reference. For more information on the Follow the requirements for the oscillator schematic, see the device-specific data sheet.

3 Installation

The F28069M LaunchPad is supported in both Code Composer Studio and Energia. Depending on your tools preference you may wish to install one or the other or both.

3.1 Energia

Go to Energia.nu and click on the Guide tab. Click on the link for your operating system and follow the directions to install Energia.

3.2 Code Composer Studio

3.2.1 Download the Required Software

Code Composer Studio IDE (www.ti.com/ccs) is available for free without any restriction when used with the XDS100v2 debug probe on the C2000 LaunchPad. Drivers, examples, and other support software needed to get started are distributed through C2000Ware (www.ti.com/tool/c2000ware) and controlSUITE (www.ti.com/tool/controlsuite). C2000Ware is the recommended download for new installations.

For InstaSPIN motor control projects, install and run the latest version of MotorWare.exe (www.ti.com/motorware). In the window that opens, under Resources, follow the Kit Readme and GUI Quick Start Guide for the LAUNCHXL-F28069M.

3.2.2 Install the Software

Once downloaded, install Code Composer Studio and C2000Ware or controlSUITE.

3.2.3 Install the Hardware

After Code Composer Studio is installed, plug the supplied USB cable into the C2000 LaunchPad board and into an available USB port on your computer.

Windows® will automatically detect the hardware and ask you to install software drivers. Let Windows run a search for the drivers and automatically install them. After Windows successfully installs the drivers for the integrated XDS100v2 debug probe, your LaunchPad is now ready for use.

NOTE: If the USB Serial COM Port is not identified by the computer, reprogram the XDS100v2 EEPROM using [these instructions](#).

4 Getting Started With the LAUNCHXL-F28069M

4.1 Getting Started

The first time the LAUNCHXL-F28069M is used, a demo application automatically starts when the board is powered from a USB host. If your board does not start the demo application, try placing S1 in the following positions and resetting the board: UP - UP - DOWN. To start the demo, connect the LAUNCHXL-F28069M with the included mini-USB cable to a free USB port. The demo application starts with the LEDs flashing to show the device is active.

4.2 Demo Application, Internal Temperature Measurement

The LAUNCHXL-F28069M includes a pre-programmed TMS320F28069M device. When the LaunchPad is connected via USB, the demo starts with an LED flash sequence. After a few seconds the device switches into a temperature measurement mode.

A reference temperature is taken at the beginning of this mode and the LEDs of the LaunchPad are used to display any difference between the current temperature and the reference temperature. If the device gets warmer than the reference temperature the red LED is lit with an intensity proportional to the temperature difference. However, if the device cools down compared to the reference temperature, a blue LED is lit in the same fashion.

In addition to the LED display, temperature information is also displayed on your PC through the USB/UART connection. To view the UART information on your PC, first figure out the COM port associated with the LaunchPad. To do this in Windows, right click on *My Computer* and click on *Properties*. In the dialog box that appears, click on the Hardware tab and open *Device Manager*. Look for an entry under Ports (COM & LPT) titled "XDS100 Class USB Serial Port (COMX)", where X is a number.

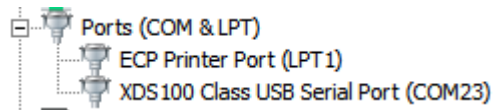

Figure 2. USB Serial Port

NOTE: If the USB Serial COM Port is not identified by the computer, reprogram the XDS100v2 EEPROM using [these instructions](#).

Remember this number for when you open a serial terminal. The demo applications UART data was written and debugged using PuTTY, and for the best user experience we recommend you use PuTTY to view the UART data. PuTTY can be downloaded from the following URL:

<http://www.chiark.greenend.org.uk/~sgtatham/putty/download.html>

Open your serial terminal program and open the COM port you found previously in device manager with the following settings: 115200 Baud, 8 data bits, no parity, 1 stop bit. After opening the serial port in your serial terminal, reset the Launchpad with the reset push button and observe the serial terminal for a surprise.

4.3 Program and Debug the Temperature Measurement Demo Application

The project and associated source code for the C2000 Piccolo LaunchPad demo is included in the controlSUITE software package and should automatically be found by the TI Resource Explorer in Code Composer Studio v6. In the resource explorer, open the controlSUITE folder and then the Development Tools entry and look for the C2000 LaunchPad line item. Expand this item and LAUNCHXL-F28069M, then select the LaunchPad Demo Application. Follow the steps in the main pane of the resource explorer to import, build, debug, and run this application.

5 Hardware Configuration

The F28069M LaunchPad gives users several options as to how to configure the board.

5.1 Power Domain

The F28069M LaunchPad has several different power domains to enable JTAG isolation. Jumpers JP1, JP2, JP3, JP4, and JP5 configure where power is passed.

Jumper	Power Domain
JP1	Enable 3.3 V from USB (disables isolation)
JP2	Enable GND from USB (disables isolation)
JP3	Enable 5 V switcher (powered off 3.3 V supply of target device)
JP4	Connects target MCU 3.3 V to second set of BoosterPack headers
JP5	Connects target MCU 5 V to second set of BoosterPack headers

5.2 Serial Connectivity

The LAUNCHXL-F28069M has a USB to UART adapter built in. This makes it easy to print debug information back to the host PC even in isolated environments. The F28069M device on this LaunchPad contains two SCI (UART) peripherals, while the LaunchPad has three places these peripherals need to be routed. Because of this, a serial connectivity mux has been added to the board to make configuration of the SCI routing easy. Routing is configured via two jumpers (JP6 and JP7). Configure the jumpers as shown in [Table 1](#) for the serial connectivity you desire.

Table 1. Serial Connectivity

MUX_SEL (JP7)	CH_SEL(JP 6)	Function
ON	ON	USB/UART Disabled; J1.3 and J1.4 – GPIO28 and GPIO29; J7.3 and J7.4 – GPIO15 and GPIO58
ON	OFF	USB/UART – GPIO28 and GPIO29, J1.3 and J1.4 – Hi-Z; J7.3 and J7.4 – GPIO15 and GPIO58
OFF	ON	USB/UART – GPIO15 and GPIO58; FAULT/OCTW – GPIO28 and GPIO29; J7.3 and J7.4 – Hi-Z
OFF	OFF	USB/UART – GPIO15 and GPIO58; FAULT/OCTW – GPIO28 and GPIO29; J7.3 and J7.4 – Hi-Z

NOTE: If the USB Serial COM Port is not identified by the computer, reprogram the XDS100v2 EEPROM using [these instructions](#).

5.3 Boot Mode Selection

The LaunchPad's F28069M device includes a boot ROM that performs some basic start-up checks and allows for the device to boot in many different ways. Most users will either want to perform an emulation boot or a boot to flash (if they are running the application standalone). S1 has been provided to allow users to easily configure the pins that the boot ROM checks to make this decision.

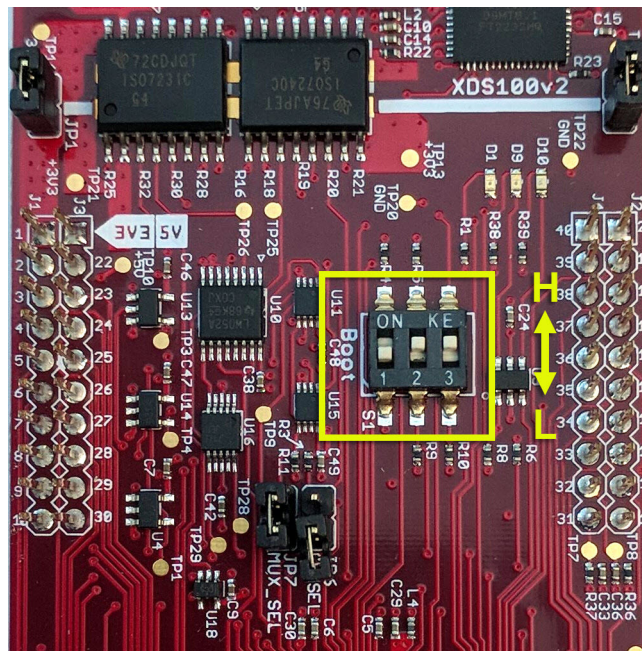

Figure 3. Boot Switch Orientation

The boot modes shown in [Table 2](#) can be selected using S1:

Table 2. S1 Boot Mode Settings

Boot Mode	S1-Switch 1 (GPIO34) H = Pulled to 1 L = Pulled to 0	S1-Switch 2 (GPIO37 / TDO) H = Pulled to 1 L = Pulled to 0	S1-Switch 3 (TRSTn) H = XDS100v2 ⁽¹⁾ L = Tied to 0
Emulation Boot ⁽²⁾	L	H	H
Parallel IO	L	L	L
SCI	H	L	L
Wait	L	H	L
GetMode	H	H	L

- (1) TRSTn is controlled by the XDS100v2 when Switch 3 is set to the H position. While connected to the device, TRSTn is driven to 1 by the XDS100v2. While disconnected from the device, TRSTn is pulled to 0.
- (2) When the board is first powered on through the XDS100v2 USB port, the device will boot before the user can connect to the device. Therefore, Switch 1 and Switch 2 should be configured to the Wait boot mode to hold the CPU in a safe state until the user can connect to the device.

NOTE: The USB debugger cannot connect to the device when S1-Switch 3 is placed in the L position because TRSTn is disconnected from the XDS100v2.

More information about boot mode selection can be found in the *Boot ROM* section of the [TMS320x2806x Piccolo technical reference guide](#).

5.4 Connecting a Crystal

Although the Piccolo device present on the LAUNCHXL-F28069M has an internal oscillator — and for most applications this is sufficient — the LaunchPad offers a footprint for through-hole HC-49 crystals for users who require a more precise clock. If you wish to use an external crystal, solder the crystal to the Q1 footprint and appropriate load capacitors to the C3 and C4 footprints. You also need to configure the device to use the external oscillator in software.

5.5 Connecting a BoosterPack

The F28069M LaunchPad is the perfect experimenter board to start hardware development with the F2806x devices. All of the connectors are aligned in a 0.1-in (2.54-mm) grid to allow easy and inexpensive development of add on boards called BoosterPacks. These satellite boards can access all of the GPIO and analog signals. The the pin out of the connectors can be found in [Section 5](#).

5.6 Device Migration Path

Applications developed on the LAUNCHXL-F28069M can easily be migrated to any of these lower cost devices in the F2806x family:

Part Number	Description
TMS320F28069	32-Bit Real Time Microcontroller, 90 MHz, 256KB Flash, 100KB RAM
TMS320F28069F	32-Bit Real Time Microcontroller, 90 MHz, 256KB Flash, 96KB RAM
TMS320F28069M	32-Bit Real Time Microcontroller, 90 MHz, 256KB Flash, 96KB RAM
TMS320F28068	32-Bit Real Time Microcontroller, 90 MHz, 256KB Flash, 100KB RAM
TMS320F28068F	32-Bit Real Time Microcontroller, 90 MHz, 256KB Flash, 96KB RAM
TMS320F28068M	32-Bit Real Time Microcontroller, 90 MHz, 256KB Flash, 96KB RAM
TMS320F28067	32-Bit Real Time Microcontroller, 90 MHz, 256KB Flash, 100KB RAM
TMS320F28066	32-Bit Real Time Microcontroller, 90 MHz, 256KB Flash, 68KB RAM
TMS320F28065	32-Bit Real Time Microcontroller, 90 MHz, 128KB Flash, 100KB RAM
TMS320F28064	32-Bit Real Time Microcontroller, 90 MHz, 128KB Flash, 100KB RAM
TMS320F28063	32-Bit Real Time Microcontroller, 90 MHz, 128KB Flash, 100KB RAM
TMS320F28062	32-Bit Real Time Microcontroller, 90 MHz, 128KB Flash, 52KB RAM
TMS320F28062F	32-Bit Real Time Microcontroller, 90 MHz, 128KB Flash, 52KB RAM

6 LAUNCHXL-F28069M Hardware

6.1 Device Pin Out

The F28069M LaunchPad is not 100% compatible with the BoosterPack Standard pin out. To verify compatibility between a BoosterPack and this LaunchPad, consult both the tables below as well as the pin out requirements of the BoosterPack. TI provides a tool that can help ease this process. Use the [Ti BoosterPack Checker tool](#). Some existing BoosterPacks can be used, or one can be created.

[Table 3](#) through [Table 6](#) lists the pin out and pin mux options for the C2000 LaunchPad.

The F28069M LaunchPad is not 100% compatible with the BoosterPack Standard pin out. To verify compatibility between a BoosterPack and this LaunchPad, consult both the tables below as well as the pin out requirements of the BoosterPack. TI provides a tool that can help ease this process. Use the [TI BoosterPack Checker tool](#). Some existing BoosterPacks can be used, or one can be created.

Table 3. F28069M LaunchPad Pin Out and Pin Mux Options - J1, J3

Mux Value				J1 Pin	J3 Pin	Mux Value			
3	2	1	0			0	1	2	3
			+3.3V	1	21	+5V			
			ADCINA6	2	22	GND			
			J1.3	3	23	ADCINA7			
			J1.4	4	24	ADCINB1			
SPISIMOB	SCITXDA	$\overline{TZ1}$	GPIO12	5	25	ADCINA2			
			ADCINB6	6	26	ADCINB2			
XCLKOUT	SCITXDB	SPICLKA	GPIO18	7	27	ADCINA0			
SCITXDB	MCLKXA	EQEP1S	GPIO22	8	28	ADCINB0			
ADCSOCBO	EPWMSYNCO	SCLA	GPIO33	9	29	ADCINA1			
ADCSOCAO	EWPMYNCO	SDAA	GPIO32	10	30	NC			

Table 4. F28069M LaunchPad Pin Out and Pin Mux Options - J4, J2

Mux Value				J4 Pin	J2 Pin	Mux Value			
3	2	1	0			0	1	2	3
Rsvd	Rsvd	EPWM1A	GPIO0	40	20	GND			
COMP1OUT	Rsvd	EPWM1B	GPIO1	39	19	GPIO19	$\overline{SPISTEA}$	SCIRXDB	ECAP1
Rsvd	Rsvd	EPWM2A	GPIO2	38	18	GPIO44	MFSRA	SCIRXDB	EPWM7B
COMP2OUT	SPISOMIA	EPWM2B	GPIO3	37	17	NC			
Rsvd	Rsvd	EPWM3A	GPIO4	36	16	RESET#			
ECAP1	SPISIMOA	EPWM3B	GPIO5	35	15	GPIO16	SPISIMOA	Rsvd	$\overline{TZ2}$
SPISOMIB	Rsvd	$\overline{TZ2}$	GPIO13	34	14	GPIO17	SPISOMIA	Rsvd	$\overline{TZ3}$

Table 4. F28069M LaunchPad Pin Out and Pin Mux Options - J4, J2 (continued)

Mux Value				J4 Pin	J2 Pin	Mux Value			
3	2	1	0			0	1	2	3
			NC	33	13	GPIO50	EQEP1A	MDXA	TZ1
			DAC1	32	12	GPIO51	EQEP1B	MDRA	TZ2
			DAC2	31	11	GPIO55	SPISOMIA	EQEP2B	HRCAP2

Table 5. F28069M LaunchPad Pin Out and Pin Mux Options - J5, J7

Mux Value				J5 Pin	J7 Pin	Mux Value			
3	2	1	0			0	1	2	3
			+3.3 V	41	61	+5 V			
			NC	42	62	GND			
			J7.3	43	63	ADCINB7			
			J7.4	44	64	ADCINB4			
COMP1OUT	MDXA	EQEP1A	GPIO20	45	65	ADCINA5			
			NC	46	66	ADCINB5			
SPICLKB	SCITXDB	TZ3	GPIO14	47	67	ADCINA3			
COMP2OUT	MDRA	EQEP1B	GPIO21	48	68	ADCINB3			
SCIRXDB	MFSXA	EQEP1I	GPIO23	49	69	ADCINA4			
HRCAP1	EQEP2A	SPISIMOA	GPIO54	50	70	NC			

Table 6. F28069M LaunchPad Pin Out and Pin Mux Options - J8, J6

Mux Value				J8 Pin	J6 Pin	Mux Value			
3	2	1	0			0	1	2	3
EPWMSYNCO	EPWMSYNCI	EPWM4A	GPIO6	80	60	GND			
ECAP2	SCIRXDA	EPWM4B	GPIO7	79	59	GPIO27	HRCAP2	EQEP2S	SPISTEB
ADCSOCAO	Rsvd	EPWM5A	GPIO8	78	58	GPIO26	ECAP3	EQEP2I	SPICLKB
ECAP3	SCITXDB	EPWM5B	GPIO9	77	57	NC			
ADCSOCBO	Rsvd	EPWM6A	GPIO10	76	56	RESET#			
ECAP1	SCIRXDB	EPWM6B	GPIO11	75	55	GPIO24	ECAP1	EQEP2A	SPISIMOB
			NC	74	54	GPIO25	ECAP2	EQEP2B	SPISOMIB
			NC	73	53	GPIO52	EQEP1S	MCLKXA	TZ3
			DAC3	72	52	GPIO53	EQEP1I	MFSXA	Rsvd
			DAC4	71	51	GPIO56	SPICLKA	EQEP2I	HRCAP3

6.2 Schematics

Figure 4 shows the F28069M LaunchPad schematic.

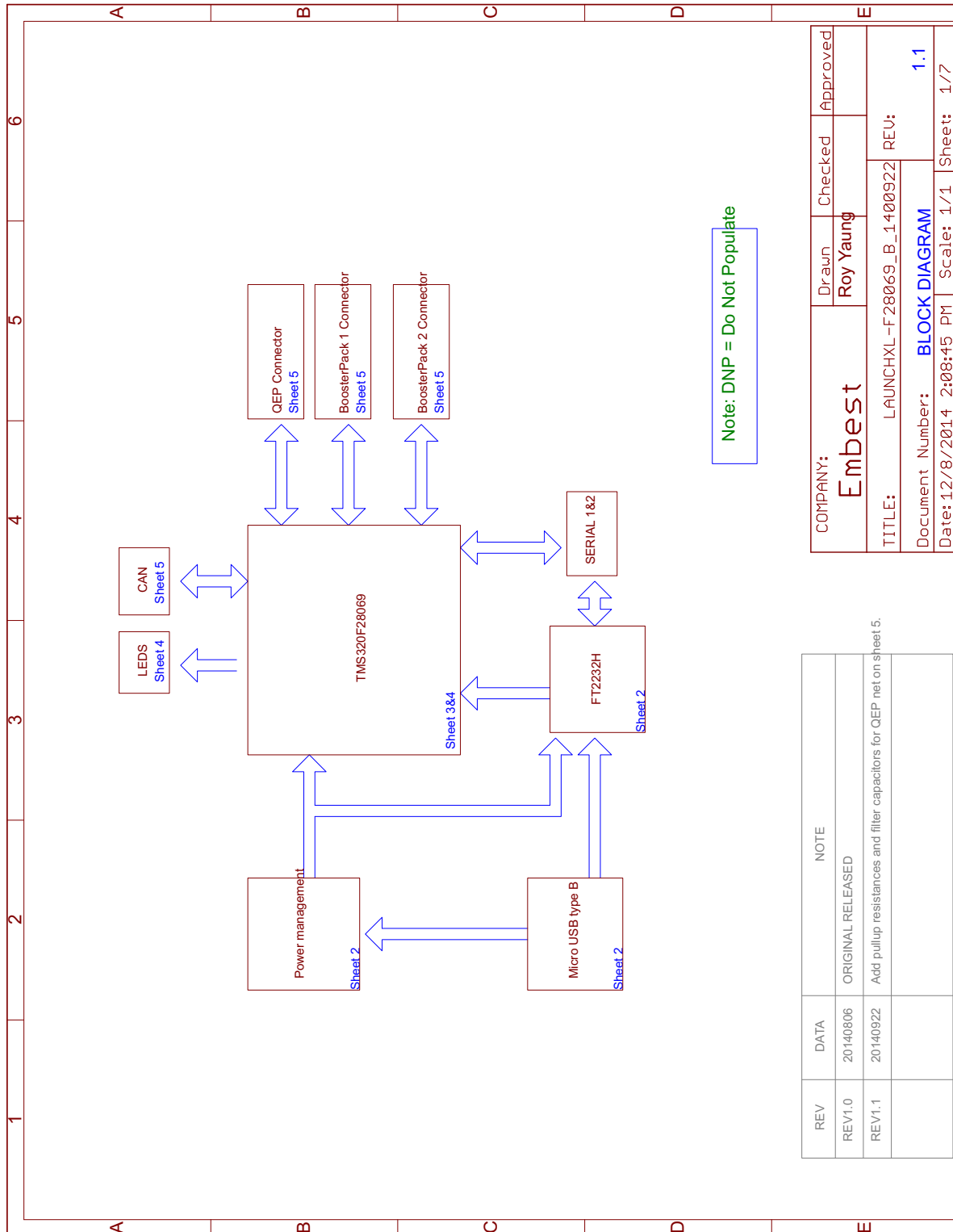

Figure 4. LAUNCHXL-F28069_B_1400922 Block Diagram Schematic

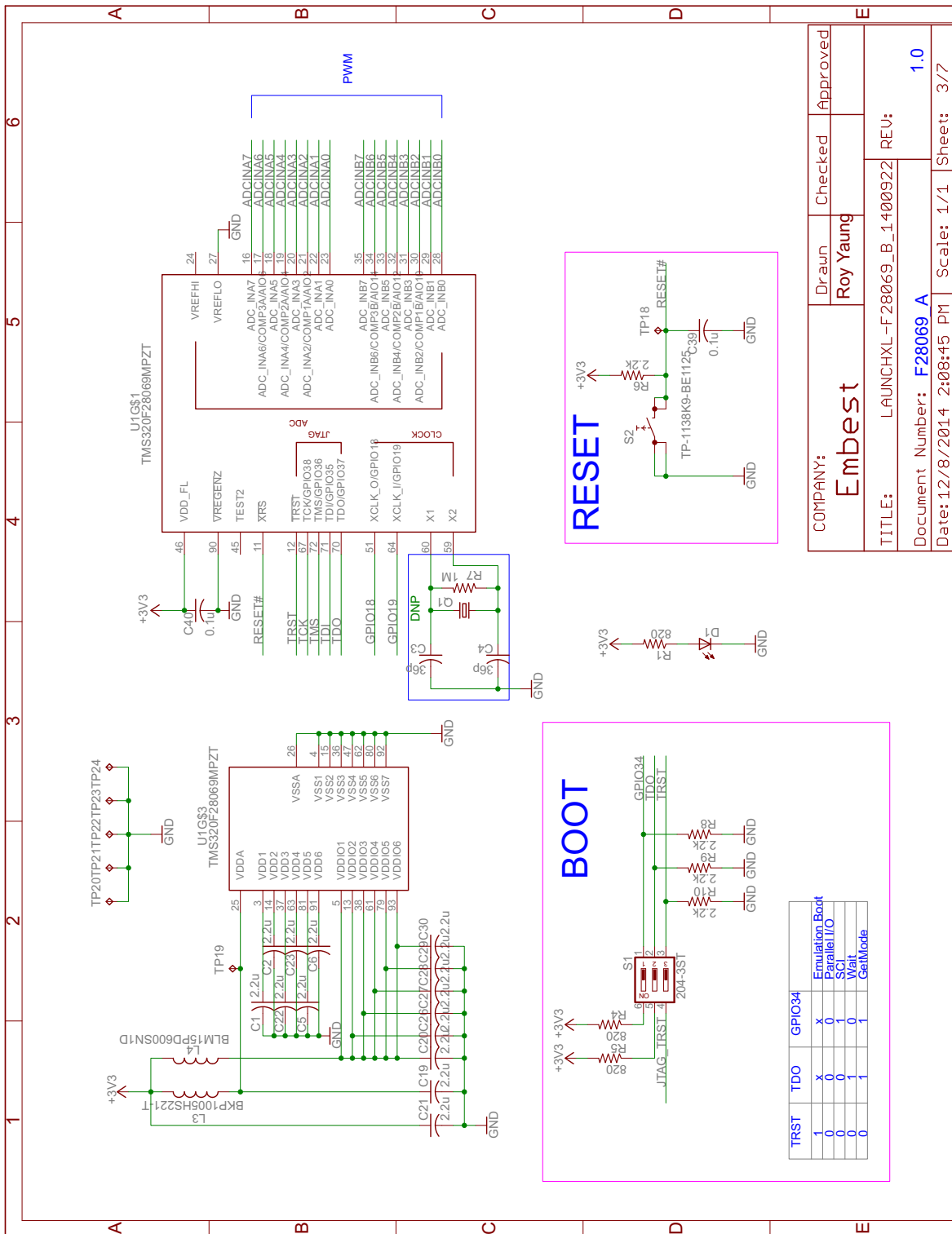

Figure 6. LAUNCHXL-F28069_B_1400922 F28069_A Schematic

COMPANY:	Embest	Drawn	Roy Young	Checked	Approved
TITLE:	LAUNCHXL-F28069_B_1400922	REV: 1.0			
Document Number:	F28069_A	Date:	12/8/2014 2:08:45 PM	Scale:	1/1 Sheet: 3/7

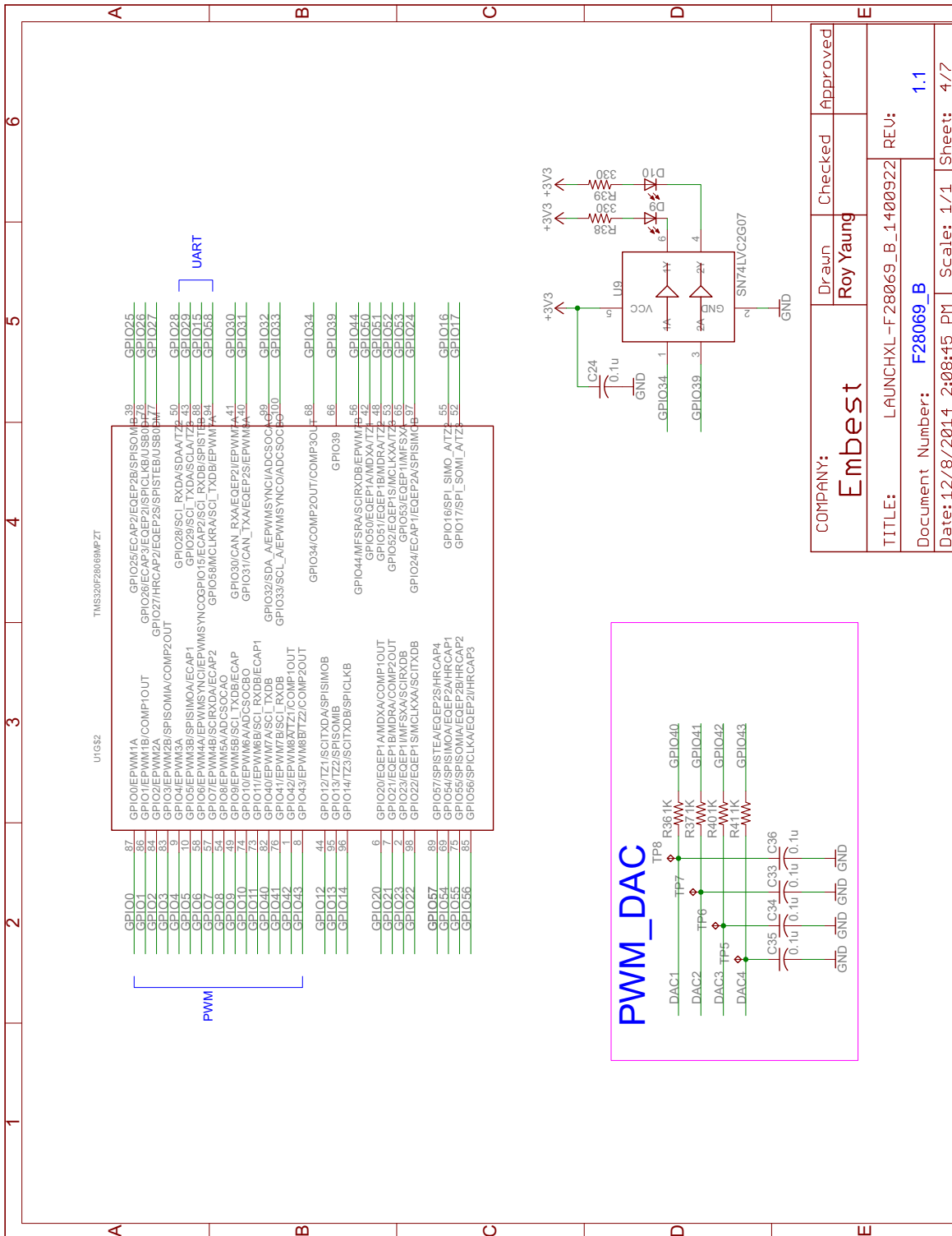

Figure 7. LAUNCHXL-F28069_B_1400922 F28069_B Schematic

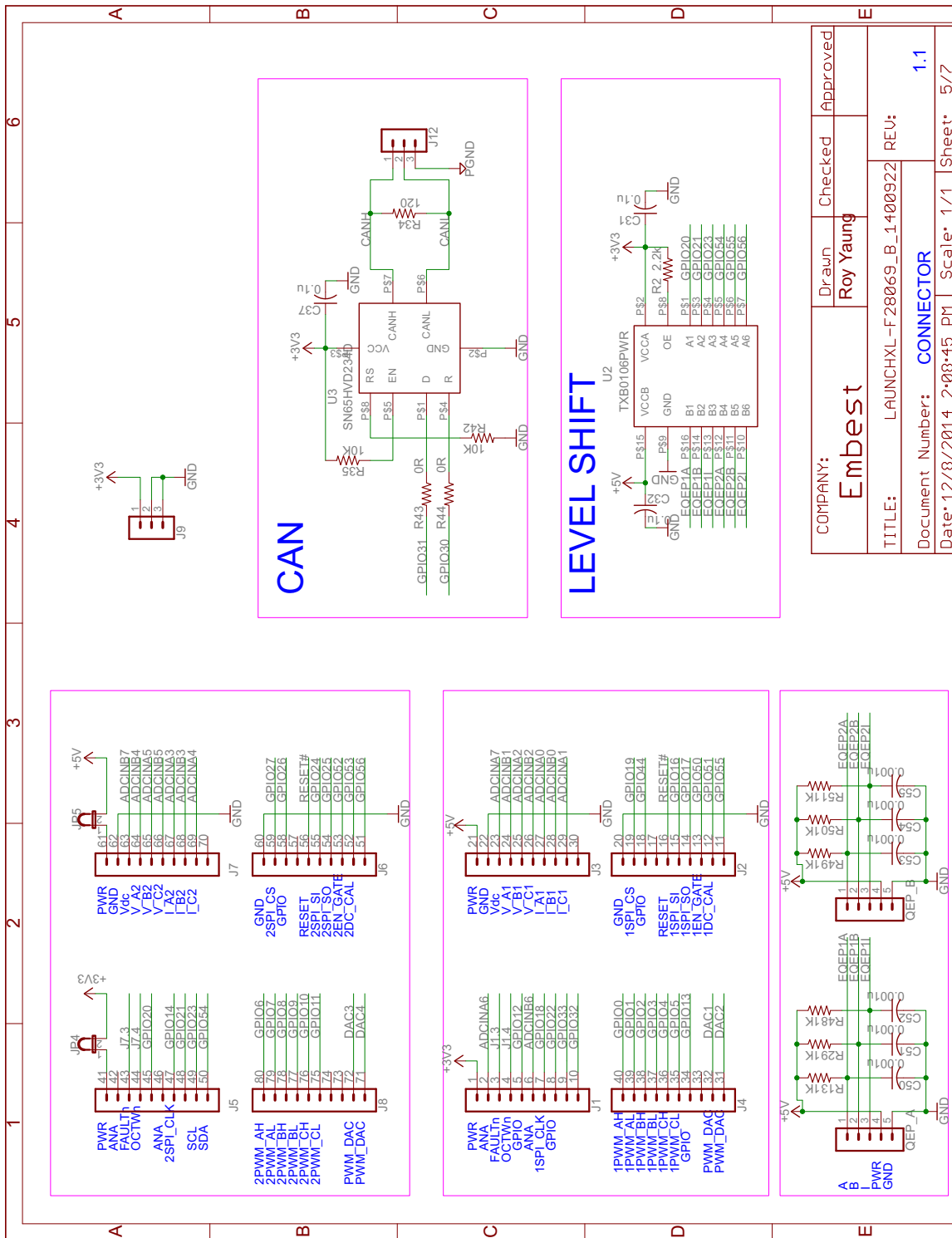

Figure 8. LAUNCHXL-F28069_B_1400922 Connector Schematic

COMPANY:	Embest	Drawn	Checked	Approved
TITLE:	LAUNCHXL-F28069_B_1400922	Roy Young		
Document Number:	CONNECTOR	REV: 1.1		
Date:	12/8/2014	2:08:45 PM	Scale: 1/1	Sheet: 5/7

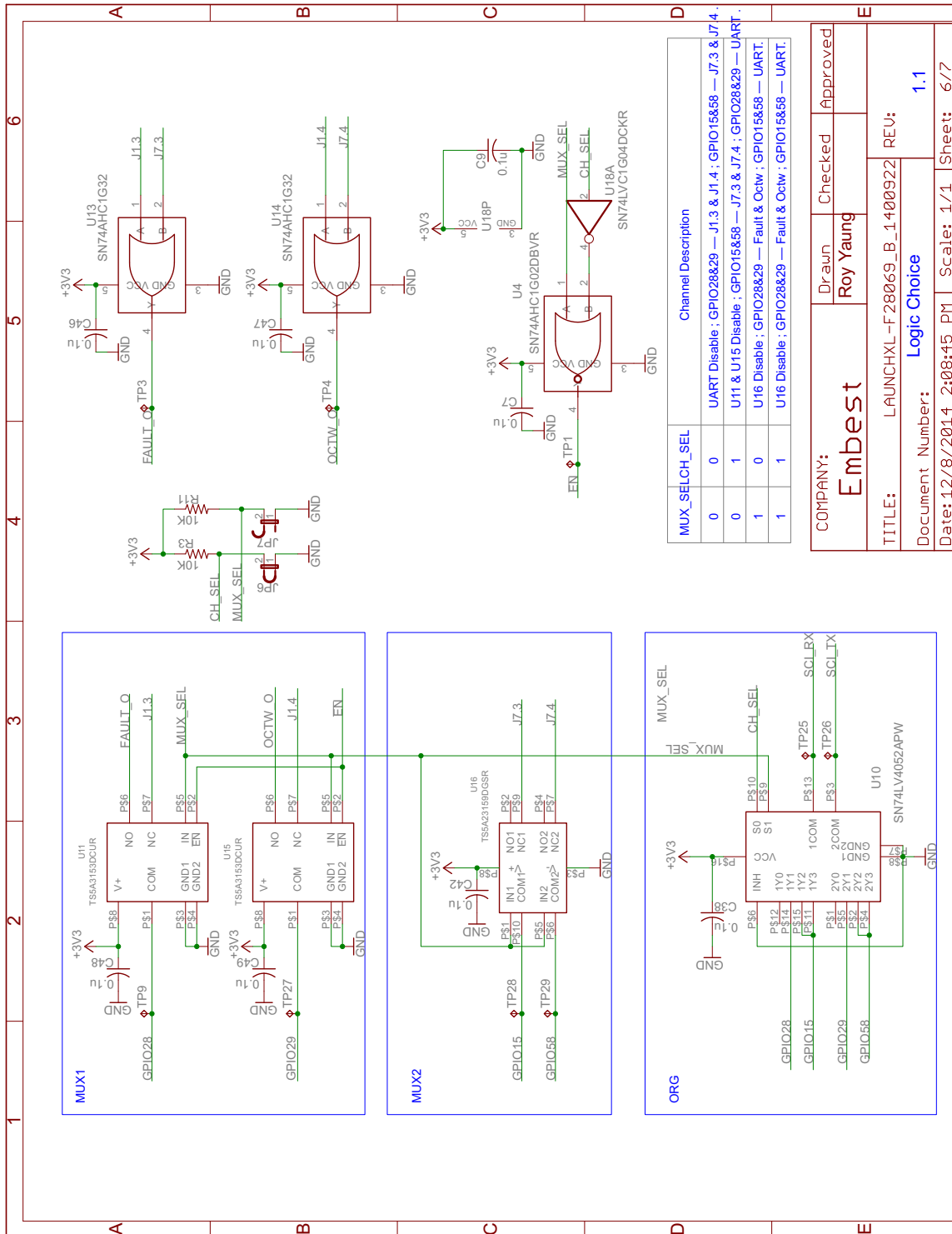
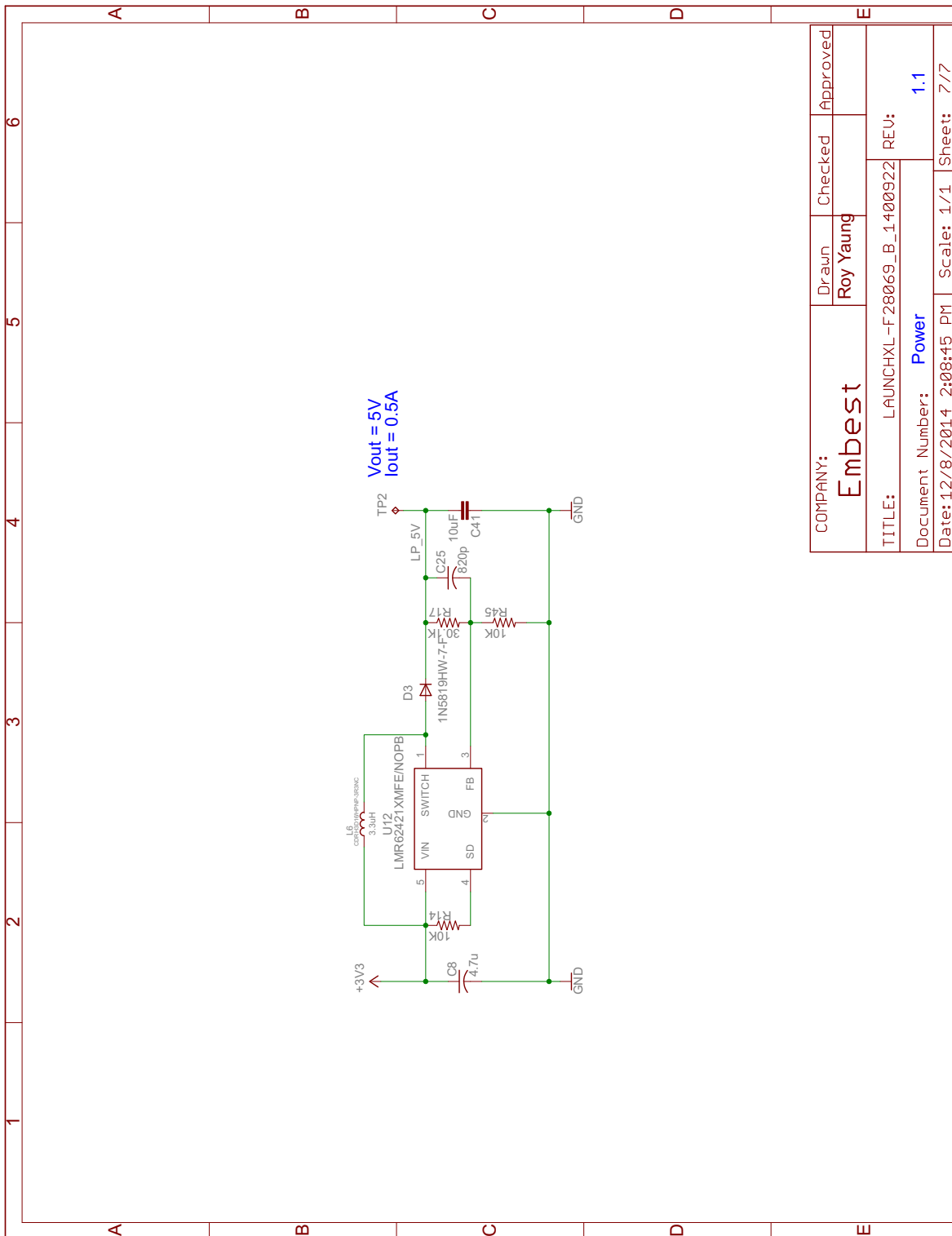

Figure 9. LAUNCHXL-F28069_B_1400922 Logic Choice Schematic



COMPANY: Embest	Drawn	Checked	Approved
	Roy Young		
TITLE:	LAUNCHXL-F28069_B_1400922 REV:		
Document Number:	Power	1.1	
Date:	12/8/2014 2:08:45 PM	Scale:	1/1 Sheet: 7/7

Figure 10. LAUNCHXL-F28069_B_1400922 Power Schematic

6.3 PCB Layout

Figure 11 through Figure 16 shows the LAUNCHXL-F28069M PCB layout.

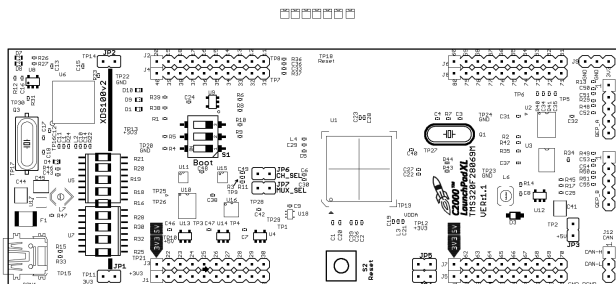

Figure 11. Top Silk

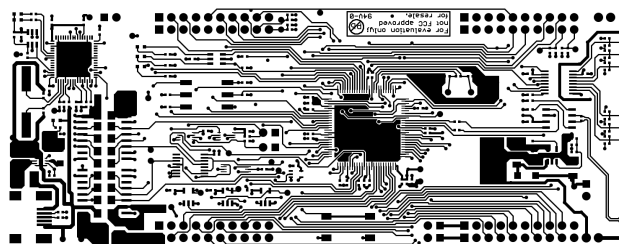

Figure 12. Top Copper

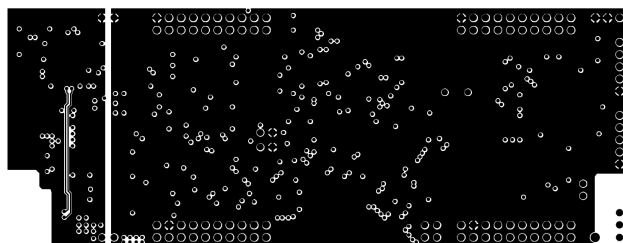

Figure 13. Inner Copper 1

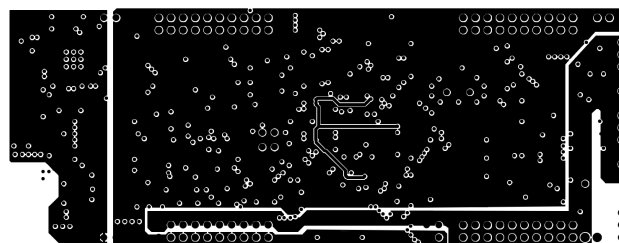

Figure 14. Inner Copper 2

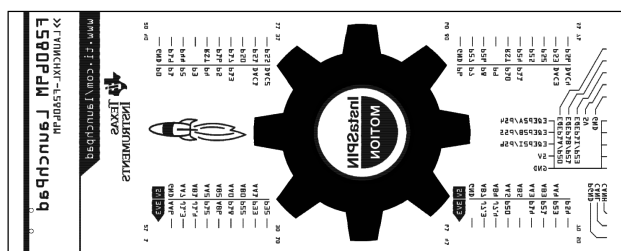

Figure 15. Bottom Silk

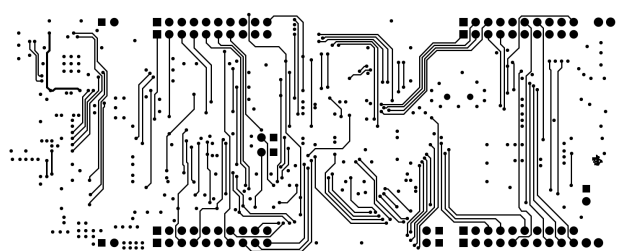

Figure 16. Bottom Copper

6.4 Bill of Materials (BOM)

Table 7 lists the LAUNCHXL-F28069M bill of materials.

Table 7. LAUNCHXL-F28069M Bill of Materials

S No	Category	MPN	Per	Mfg.	Description	Package	Value	Working Voltage	Reference
1	PCB	LAUNCHXL-F28069M PCB	1		4 layers PCB, Red Soldermask, white Silkscreen, Immersion gold, 51 mm*130.5 mm, LAUNCHXL-F28069M PCB				
2	MCU	TMS320F28069MPZT	1	TI	MCU 32-bit C2000 C28x RISC 128KB Flash 3.3 V 100-Pin LQFP, customer supply	LQFP-100		1.71~1.995 V	U1
3	Memory	93LC56BT-I/OT	1	Microchip	IC, EEPROM Serial-Microwire 2K-Bit 128 x 16 2 MHz, 93LC56BT-I/OT, SOT-23-6, SMD	SO-23-6	2Kb	2.5~5.5 V	U8
4	DC-DC	LMR62421XMF/NOPB	1	TI	Conv DC-DC Single Step Up 2.7 V to 5.5 V 5-Pin SOT-23 T/R, customer supply	SOT23-5		2.7 V to 5.5 V	U12
5	DC-DC	TPS62162DSGR	1	TI	Conv DC-DC Single Step Down 3 V to 17 V 8-Pin WSON EP T/R, customer supply	WSON-8		3 V to 17 V	U17
6	Logic	SN74AHC1G32DBVR	2	TI	IC, Single 2-Input Positive-OR Gate, SN74AHC1G32DBVR, SOT23-5, SMD, customer supply	SOT23-5		2~5.5 V	U13,U14
7	Logic	TXB0106PWR	1	TI	IC, 6-BIT Bidirectional Voltage-Level Translator with Auto-Direction Sensing and ±15-kV ESD Protection, TXB0106PWR, TSSOP-16, SMD, customer supply	TSSOP-16		1.2~5.5 V	U2
8	Logic	SN74LV4052APW	1	TI	Analog Multiplexer Dual 4:1 16-Pin TSSOP Tube, customer supply	TSSOP-16		2~5.5 V	U10
9	Logic	SN74LVC2G07DBVR	1	TI	Buffer/Driver 2-CH Non-Inverting Open Drain CMOS 6-Pin SOT-23 T/R, customer supply	SOT23-6		1.65~5.5 V	U9
10	Logic	SN74LVC1G04DCKR	1	TI	IC, Single Inverter Gate, SN74LVC1G04DCKR, SC70-5, SMD	SC70-5		1.65 V ~ 5.5 V	U18
11	Logic	SN74AHC1G02DBVR	1	TI	"IC, NOR Gate 1-Element 2-IN CMOS, SN74AHC1G02DBVR, SOT23-5, SMD	SOT23-5		2 V ~ 5.5 V	U4
12	Interface	SN65HVD234D	1	TI	IC, 3.3 V CAN Transceiver with Sleep Mode, SN65HVD234D, SOIC-8, SMD, customer supply	SO-8		3.3V	U3
13	Interface	FT2232HQ-REEL	1	FTDI	IC, Dual High Speed USB to Multipurpose UART/FIFO IC, FT2232HQ-REEL, QFN-64, SMD	QFN-64		1.62 V to 1.98 V	U6
14	Interface	TS5A3153DCUR	2	TI	Analog Switch Single SPDT 8-Pin VSSOP T/R, customer supply	VSSOP-8		1.65~5.5 V	U11, U15
15	Interface	TS5A23159DGSR	1	TI	Analog Switch Dual SPDT 10-Pin VSSOP T/R, customer supply	VSSOP-10		1.65~5.5 V	U16
16	Isolator	ISO7231CDWR	1	TI	IC DGTL ISO 3CH CMOS 16SOIC, customer supply	SO-16		3.15~5.5 V	U7
17	Isolator	ISO7240CDWR	1	TI	IC DGTL ISO 4CH CMOS 16SOIC, customer supply	SO-16		3.15~5.5 V	U5
18	Thick film Resistor	RC0402JR-070RL	4	YAGEO	RES, 0R, ±5%, 1/16W, SMD0402	0402	0R	50 V	R15, R33, R43, R44
19	Thick film Resistor	RC0402JR-07120RL	1	YAGEO	RES, 120R, ±5%, 1/16W, SMD0402	0402	120R	50 V	R34
20	Thick film Resistor	RC0402JR-07330RL	4	YAGEO	RES, 330R, ±5%, 1/16W, SMD0402	0402	330R	50 V	R26, R27, R38, R39

Table 7. LAUNCHXL-F28069M Bill of Materials (continued)

S No	Category	MPN	Per	Mfg.	Description	Package	Value	Working Voltage	Reference
21	Thick film Resistor	RC0402JR-07820RL	4	YAGEO	RES, 820R, ±5%, 1/16W, SMD0402	0402	820R	50 V	R1, R4, R5, R46
22	Thick film Resistor	RC0402JR-071KL	6	YAGEO	RES, 1K, ±5%, 1/16W, SMD0402	0402	1K	50 V	R22, R23, R36, R37, R40, R41
23	Thick film Resistor	RC0402JR-072K2L	6	YAGEO	RES, 2K2, ±5%, 1/16W, SMD0402	0402	2K2	50 V	R2, R6, R8, R9, R10, R31
24	Thick film Resistor	RC0402JR-0710KL	7	YAGEO	RES, 10K ±5%, 1/16W, SMD0402	0402	10K	50 V	R3, R11, R12, R14, R35, R42, R45
25	Thick film Resistor	RC0402FR-0712KL	1	YAGEO	RES, 12K, ±1%,1/16W, SMD0402	0402	12K	50 V	R24
26	Thick film Resistor	RC0402FR-0730K1L	1	YAGEO	RES, 30K1, ±1%, 1/16W, SMD0402	0402	30K1	50 V	R17
27	Thick film Resistor	RC0402JR-07100KL	1	YAGEO	RES, 100K, ±5%, 1/16W, SMD0402	0402	100K	50 V	R47
28	Ceramic Capacitor	GRM1555C1H821JA01D	1	Murata	CAP, 820PF, ±5%, C0G, 50 V, SMD0402	0402	820PF	50 V	C25
29	Ceramic Capacitor	GRM155R71C104KA88D	23	Murata	CAP, 100 NF, ±10%, X7R,16 V, SMD0402	0402	100 NF	16 V	C7, C9, C12, C13, C14, C16, C24, C31, C32, C33, C34, C35, C36, C37, C38, C39, C40, C42, C43, C46, C47, C48, C49
30	Ceramic Capacitor	GRM155R60J225ME15D	14	Murata	CAP, 2.2 µF, ±20%, X5R, 6.3 V, SMD0402	0402	2.2 µF	6.3 V	C1, C2, C5, C6, C19, C20, C21, C22, C23, C26, C27, C28, C29, C30
31	Ceramic Capacitor	GRM32DR71E106KA12L	2	Murata	CAP, 10 µF, ±10%, X7R, 25 V, SMD1210	1210	10 µF	25 V	C41, C44
32	Ceramic Capacitor	CC1210KKX5R7BB226	1	YAGEO	CAP, 22 µF, ±10%, X5R, 16 V, SMD1210	1210	22 µF	16 V	C45
33	Ceramic Capacitor	GRM155R60J475ME47	3	Murata	CAP, 4.7 µF, ±20%, X5R, 6.3 V, SMD0402	0402	4.7 µF	6.3 V	C8, C10, C11
34	Ceramic Capacitor	CL05A335MR5NNNC	1	Samsung	CAP, 3.3 µF, ±20%, X5R, 4 V, SMD0402	0402	3.3 uF	4 V	C15
35	Ceramic Capacitor	GRM1555C1H360JA01D	2	Murata	CAP, 36 pF, ±5%, C0G, 50 V, SMD0402	0402	36 pF	50 V	C17, C18
36	Inductor	CDRH2D18/HPNP-2R2NC	1	Sumida	Power Inductor, Magnetic shielded, 2.2 µH, 1.6A, 0.06 Ω, 3.0 x 3.0 x 1.8 mm, SMD	3.0X3.0mm	2.2 µH		L7
37	Inductor	CDRH3D16/HPNP-3R3NC	1	Sumida	Power Inductor, Magnetic shielded, 3.3 µH,1.4A, 0.085 Ω, 3.8 x 3.8 x 1.6 mm, SMD	3.8X3.8mm	3.3 µH		L6
38	Ferrite Bead	BLM15AG601SN1D	2	Murata	Ferrite Bead, 60 Ω@100 MHz, ±25%, 300 mA,0.6 Ω, SMD0402	0402	600 Ω		L1, L2
39	Ferrite Bead	BLM15PD600SN1D	1	Murata	Ferrite Bead, 60 Ω@100 MHz, ±25%,1700 mA, 0.06 Ω,SMD0402	0402	60 Ω		L4
40	Ferrite Bead	BLM15AG221SN1D	1	Murata	Ferrite Bead, 220 Ω@100 MHz, ±25%, 300 mA, 0.6 Ω, SMD0402	0402	220 Ω		L3
41	LED	19-217/R6C-AL1M2VY/3T	2	Everlight	LED, Brilliant Red, Water Clear, 20 mA, SMD0603	0603		1.7~2.3 V	D8, D9

Table 7. LAUNCHXL-F28069M Bill of Materials (continued)

S No	Category	MPN	Per	Mfg.	Description	Package	Value	Working Voltage	Reference
42	LED	19-217/G7C-AN1P2/3T	2	Everlight	LED, Super Yellow Green, Water Clear, 20 mA, SMD0603	0603		1.75~2.35 V	D1, D4
43	LED	19-217/BHC-AN1P2/3T	2	Everlight	LED, Blue, Water Clear, 20 mA, SMD0603	0603		1.7~2.2 V	D7, D10
44	Diode	1N5819HW-7-F	1	Diodes	Diode, Schottky Diode, 1N5819HW-7-F, 40 V, 1A, SOD-123, SMD	SOD-123		40 V	D3
45	Polyswitch	SMD1812P050TF	1	PTTC	Polyswitch, SMD1812P050TF, 15 V, Ihold=0.5A, Itrip=1A, 0.5 Ω, SMD1812	1812		15 V	F1
46	Crystal	7D12000182BTAF60Q5	1	Interquip	Crystal, 7D12000182BTAF60Q5, 12 MHz, ±20 PPM, 18PF, HC-49S, SMD	HC-49SMD	12 MHz		Q3
47	Pin Header	P6E02A-602530-B1	7	CHI-BAN	Connector, Pin Header, Straight, Male, 1 x 2 Pin, 2.54 MM pitch, 6.06, 3.00, Gold Flash 1μ, black, DIP	DIP			JP1, JP2, JP3, JP4, JP5, JP6, JP7
48	Pin Header	P6E03A-602530-B1	2	CHI-BAN	Connector, Pin Header, Straight, Male, 1 x 3 Pin, 2.54 MM pitch, 6.06, 3.00, Gold Flash 1μ, black, DIP	DIP			J9, J12
49	Pin Header	P101-1*05SGF-116A-NX	2	Townes	Connector, Pin Header, Straight, Male, 1 x 5 Pin, 2.54 MM pitch, 6.06, 3.00, Gold Flash 1μ, black, DIP	DIP			QEP_A, QEP_B
50	Pin Socket	CRD-081413-A-G	4	Major League	Connector, Pin Socket, Straight, Female, 2 x 10 Pin, 2.54 MM pitch, 8.5, 9.92, Gold Flash 1μ, black, DIP	DIP			J1, J2, J3, J4, J5, J6, J7, J8
51	USB Connector	UBF11-03	1	JXT	Connector, MiniUSB AB port, 5 Position, Right Angle, Gold Flash 1μ, black, SMD	SMD			CON1
52	Shunt	MJ501-EOGF-B-K	7	Townes	Connector, Shunt, 2Pin, 2.54 MM Pitch, 6 MM Height, Gold Flash 1μ, black				U\$1, U\$2, U\$9, U\$10, U\$11, U\$12, U\$13,
53	Tacticle Switch	TP-1138K9-BE1125	1	Toneparts	Switch, Tacticle, 160gf ±50gf, black housing, black plunger, 6*6*4.3 MM, SMD	SMD-4			S2
54	DIP Switch	DSIC03LSGET	1	KE	Switch, DIP SWITCH, 3 Position, 2.54 MM Pitch, black housing, white plunger, SMD	SMD			S1
55	Thick Film Resistor	RC0402FR-071KL	6	YAGEO	RES, 1K, ±1%, 1/16W, SMD0402	0402	1K	50 V	R13, R29, R48-R51
56	Ceramic Capacitor	GRM155R71H102KA01D	6	Murata	CAP, 1NF, ±10%, X7R, 50 V, SMD0402	0402	1NF	50 V	C50-C55
57	ESD bag	Anti-static bag 180*130mm	1		Anti-static bag 180*130 mm				
58	Label	700/SCH, Label, 11mm*7mm	1		700/SCH Label, 11 mm*7 mm				

7 Frequently Asked Questions (FAQ)

1. Can other programming and debug tools (such as an XDS510 debug probe) be used with the C2000 LaunchPad?

While a user could potentially connect an external debug probe to the F28069M device present on the LaunchPad, it would require some rework of the board. It is recommended that users who want to use an external debug probe purchase a controlCard and docking station that includes an external JTAG connector.

2. What versions of Code Composer Studio can be used to develop software for the C2000 LaunchPad?

It is highly recommend that novice users develop applications with Code Composer Studio v6. The drivers, examples, and other associated software are tailored to make the user experience as smooth as possible in Code Composer Studio v6.

3. Why can't I connect to the LaunchPad in Code Composer Studio?

There are a number of things that could cause this and they all have an easy fix.

- Is S1 switch 3 in the down position?

This is the TRST pin that enables and disables JTAG functionality on the chip. This switch must be in the up position for the debug probe to be able to connect.

- Are both power LEDs lit?

The board has two power domains because of the isolated JTAG interface. For low-voltage application development, JTAG isolation is not needed and the power domains can be combined to allow for convenience (that is, the board can be powered completely through the USB). Ensure that jumpers are placed on the posts of JP1 and JP2.

- Are drivers correctly installed for the XDS100v2 present on the LaunchPad?

Right click on *My Computer* and select properties. Navigate to the *Hardware* tab in the dialog box and open the device manager. Scroll to the bottom of the list and expand the *USB Serial Bus controllers* item. Are there two entries for *TI XDS100 Channel A/B*? If not, try unplugging and replugging in the board. Does Windows give you any messages in the system tray? In Device Manger, do either of the entries have a yellow exclamation mark over their icon? If so, try reinstalling the drivers.

4. Why is the serial connection not working?

The most common cause of this is the serial muxing being set incorrectly. Ensure that JP7 has a jumper placed on it while JP6 does not have a jumper before proceeding further.

- Are you using the correct COM port?

Right click on *My Computer* and select properties. Navigate to the *Hardware* tab in the dialog box and open the device manager. Scroll to *Ports (COM & LPT)* and expand this entry. Is there a USB Serial Port listed? If so, read the COM number to the right of the entry; this is the COM number you should be using.

If the USB Serial COM Port is not identified by the computer, reprogram the XDS100v2 EEPROM using [these instructions](#).

- Are you using the correct baud rate?

Most, if not all, of the examples are configured for a baud rate of 115200 when the CPU is running at 60 MHz. If you have changed the PLL settings or written your own application you may have to recalculate the baud rate for your specific application. For information on how to do this, see the [TMS320x2802x, 2803x Piccolo serial communications interface \(SCI\) reference guide](#).

8 References

The following documents describe the C2000 devices. Copies of these documents are available on the Internet at <http://www.ti.com/c2000> and www.ti.com/c2000-launchpad, or click on the links below:

- Texas Instruments: [TMS320F2806x Piccolo™ microcontrollers data manual](#)
- Texas Instruments: [TMS320F2806x Piccolo™ MCUs Silicon errata revisions B, A, 0](#)
- Texas Instruments: [TMS320x2806x Piccolo technical reference guide](#)
- Texas Instruments: [TMS320C28x extended instruction sets technical reference manual](#)
- Texas Instruments: [TMS320C28x instruction set simulator technical overview](#)
- Texas Instruments: [TMS320C28x optimizing C/C++ compiler user's guide](#)
- Texas Instruments: [TMS320C28x assembly language tools user's guide](#)
- Texas Instruments: [TMS320x2802x, 2803x Piccolo serial communications interface \(SCI\) reference guide](#)

Revision History

NOTE: Page numbers for previous revisions may differ from page numbers in the current version.

Changes from A Revision (August 2018) to B Revision	Page
• Global replace of "emulator" with "debug probe".....	1
• Added Section 2.1 to document known issues with Design	3
• Added link to XDS100 reprogram instructions	22

IMPORTANT NOTICE AND DISCLAIMER

TI PROVIDES TECHNICAL AND RELIABILITY DATA (INCLUDING DATASHEETS), DESIGN RESOURCES (INCLUDING REFERENCE DESIGNS), APPLICATION OR OTHER DESIGN ADVICE, WEB TOOLS, SAFETY INFORMATION, AND OTHER RESOURCES "AS IS" AND WITH ALL FAULTS, AND DISCLAIMS ALL WARRANTIES, EXPRESS AND IMPLIED, INCLUDING WITHOUT LIMITATION ANY IMPLIED WARRANTIES OF MERCHANTABILITY, FITNESS FOR A PARTICULAR PURPOSE OR NON-INFRINGEMENT OF THIRD PARTY INTELLECTUAL PROPERTY RIGHTS.

These resources are intended for skilled developers designing with TI products. You are solely responsible for (1) selecting the appropriate TI products for your application, (2) designing, validating and testing your application, and (3) ensuring your application meets applicable standards, and any other safety, security, or other requirements. These resources are subject to change without notice. TI grants you permission to use these resources only for development of an application that uses the TI products described in the resource. Other reproduction and display of these resources is prohibited. No license is granted to any other TI intellectual property right or to any third party intellectual property right. TI disclaims responsibility for, and you will fully indemnify TI and its representatives against, any claims, damages, costs, losses, and liabilities arising out of your use of these resources.

TI's products are provided subject to TI's Terms of Sale (www.ti.com/legal/termsofsale.html) or other applicable terms available either on ti.com or provided in conjunction with such TI products. TI's provision of these resources does not expand or otherwise alter TI's applicable warranties or warranty disclaimers for TI products.

Mailing Address: Texas Instruments, Post Office Box 655303, Dallas, Texas 75265
Copyright © 2019, Texas Instruments Incorporated

Looking for pricing, stock, or lifecycle information?

Click below to explore more details on WIN SOURCE:

 [View LAUNCHXL-F28069M on WIN SOURCE](#)

 [Texas Instruments](#) Information

Optimize Your Supply Chain with WIN SOURCE Solutions

-  Global Sourcing Solution
-  Obsolete Management
-  Cost Control Management
-  Shortage Management
-  Alternative Solution
-  Excess Inventory Management