

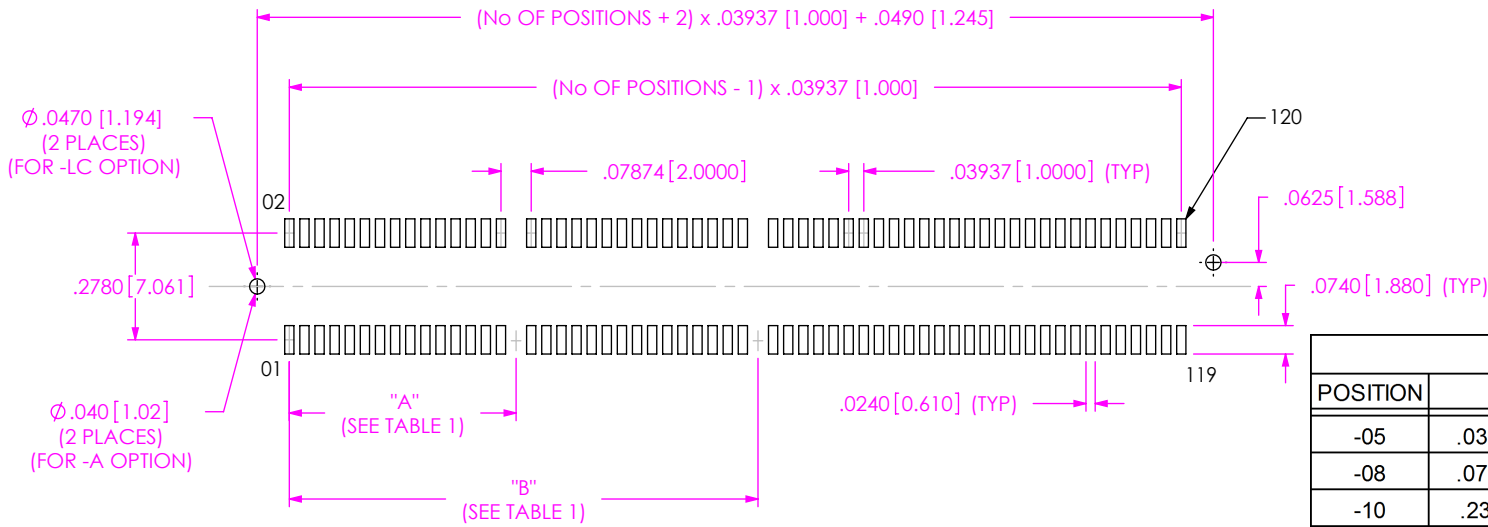

**THE DATASHEET OF
MEC1-120-02-L-D-A-K-TR**





MEC1-160-XX-XX-D-XX SHOWN

POSITION	"A"	"B"	POSITIONS POLARIZED
-05	.039 [1.00]	N/A	3, 4
-08	.079 [2.00]	N/A	5, 6
-10	.236[6.00]	N/A	13,14
-20	.276 [7.00]	N/A	15, 16
-30	.394 [10.00]	N/A	21, 22
-40	.591 [15.00]	N/A	31, 32
-50	.787 [20.00]	N/A	41, 42
-60	.591 [15.00]	1.220 [31.00]	31, 32, 63 & 64
-70	1.024 [26.00]	2.244 [57.00]	53, 54, 115 & 116

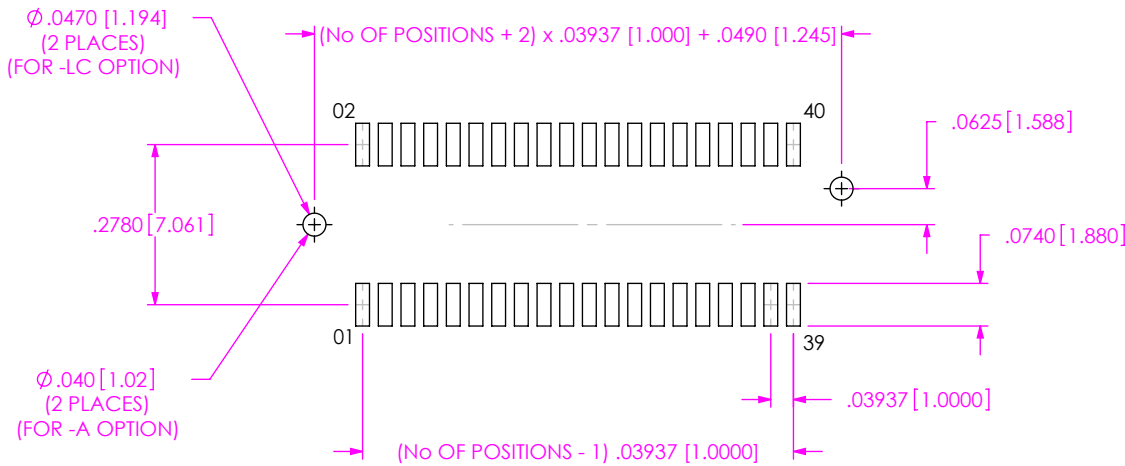

MEC1-120-XX-XX-D-NP-XX SHOWN

-NP OPTION (ONLY AVAILABLE FOR POSITIONS -05, -08,-10, -20, -30)

NOTE:
SAME AS ABOVE UNLESS OTHERWISE SPECIFIED.

UNLESS OTHERWISE SPECIFIED, DIMENSIONS ARE IN INCHES.
TOLERANCES ARE:
DECIMALS ANGLES
.XX: ±.01 [.3] 2°
.XXX: ±.005 [.13]
.XXXX: ±.0020 [.051]

PROPRIETARY NOTE
THIS DOCUMENT CONTAINS CONFIDENTIAL AND PROPRIETARY INFORMATION AND ALL DESIGN, MANUFACTURING, REPRODUCTION, USE, PATENT RIGHTS AND SALES RIGHTS ARE EXPRESSLY RESERVED BY SAMTEC, INC. THIS DOCUMENT SHALL NOT BE DISCLOSED, IN WHOLE OR PART, TO ANY UNAUTHORIZED PERSON OR ENTITY NOR REPRODUCED, TRANSFERRED OR INCORPORATED IN ANY OTHER PROJECT IN ANY MANNER WITHOUT THE EXPRESS WRITTEN CONSENT OF SAMTEC, INC.



520 PARK EAST BLVD, NEW ALBANY, IN 47150
PHONE: 812-944-6733 FAX: 812-948-5047
e-Mail info@SAMTEC.com code 55322

NOTE:
STENCIL TO BE .0060[.152] THICK.

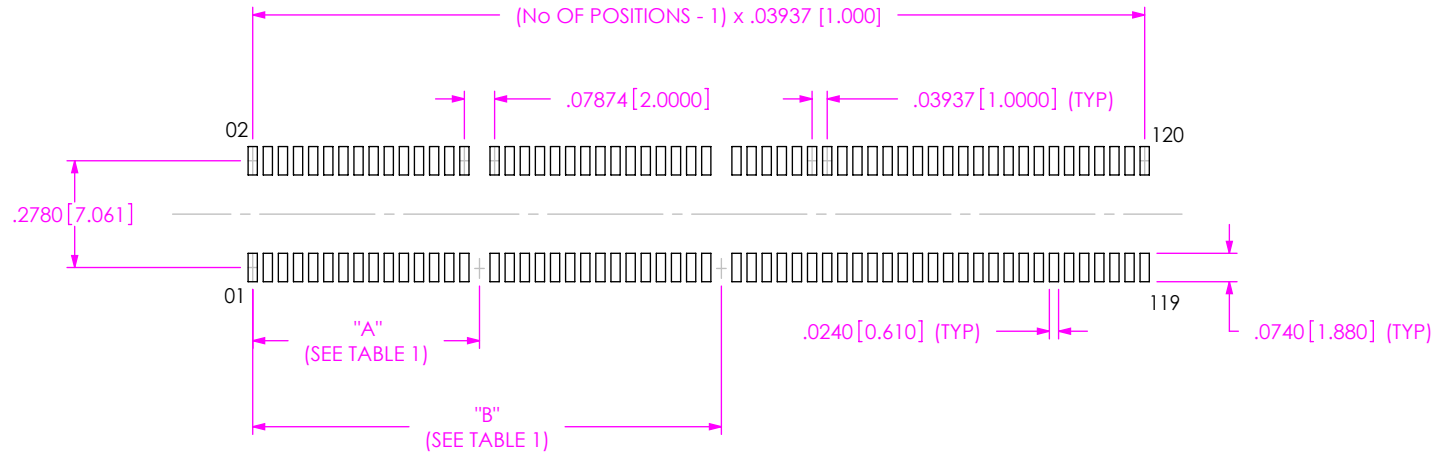

MEC1-160-XX-XX-D-XX SHOWN

TABLE 2

POSITION	"A"	"B"	POSITIONS POLARIZED
-05	.039 [1.00]	N/A	3, 4
-08	.079 [2.00]	N/A	5, 6
-10	.236[6.00]	N/A	13,14
-20	.276 [7.00]	N/A	15, 16
-30	.394 [10.00]	N/A	21, 22
-40	.591 [15.00]	N/A	31, 32
-50	.787 [20.00]	N/A	41, 42
-60	.591 [15.00]	1.220 [31.00]	31, 32, 63 & 64
-70	1.024 [26.00]	2.244 [57.00]	53, 54, 115 & 116

PROPRIETARY NOTE
THIS DOCUMENT CONTAINS CONFIDENTIAL AND PROPRIETARY INFORMATION AND ALL DESIGN, MANUFACTURING, REPRODUCTION, USE, PATENT RIGHTS AND SALES RIGHTS ARE EXPRESSLY RESERVED BY SAMTEC, INC. THIS DOCUMENT SHALL NOT BE DISCLOSED, IN WHOLE OR PART, TO ANY UNAUTHORIZED PERSON OR ENTITY NOR REPRODUCED, TRANSFERRED OR INCORPORATED IN ANY OTHER PROJECT IN ANY MANNER WITHOUT THE EXPRESS WRITTEN CONSENT OF SAMTEC, INC.



520 PARK EAST BLVD, NEW ALBANY, IN 47150
PHONE: 812-944-6733 FAX: 812-948-5047
e-Mail info@SAMTEC.com code 55322

TABLE 3

POSITION	"D" (CARD SLOT 1)	"E"(CARD SLOT 2)	"F" R	"G"	POSITIONS POLARIZED
-05	.094 [2.37]	N/A	.1575 [4.000]	.266 [6.75]	3, 4
-08	.133 [3.37]	N/A	.2756 [7.000]	.384 [9.75]	5, 6
-10	.290 [7.37]	N/A	.3543 [9.000]	.463 [11.76]	13,14
-20	.330 [8.37]	N/A	.7480 [19.000]	.857 [21.76]	15, 16
-30	.448 [11.37]	N/A	1.1417 [29.000]	1.251 [31.77]	21, 22
-40	.645 [16.38]	N/A	1.5354 [39.000]	1.645 [41.78]	31, 32
-50	.842 [21.37]	N/A	1.9291 [49.000]	2.039 [51.79]	41, 42
-60	.645 [16.38]	1.275 [32.37]	2.3228 [59.000]	2.433 [61.79]	31, 32, 63 & 64
-70	1.078 [27.37]	2.298 [58.37]	2.7165 [69.000]	2.827 [71.80]	53, 54, 115 & 116

NOTES:

- 60 AND -70 ARE THE ONLY TWO CARDS THAT HAVE TWO SLOTS.
- MIRROR IMAGE FOOTPRINT ON THE OTHER SIDE OF PCB.
- FOR NON-POLARIZED OPTION, REPLACE SLOTS WITH TRACES.
- ALL DIMENSIONS ARE SYMMETRIC ABOUT THE CENTERLINE.
- PLATING TO BE .000030 INCHES GOLD WITH HARDNESS OF 130-200 KNOOP PER ASTM B488 TYPE 2, GRADE C.
- POSITIONS -05, -08, -20 & -30 ARE POLARIZED UNLESS OTHERWISE NOTED WITH OPTION -NP.
- FOR PROPER CONTACT REGISTRATION, PLATING BUS TIES TO BE WIDTH OF THE EDGE FINGER.

TABLE 4

CARD THICKNESS	"C"
-01	.031 [0.79] ± .003 [0.08]
-02	.062 [1.57] ± .006 [0.15]

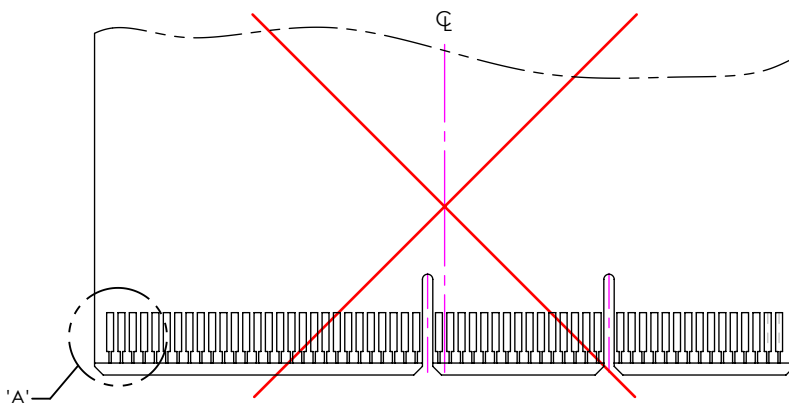
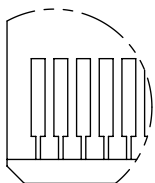
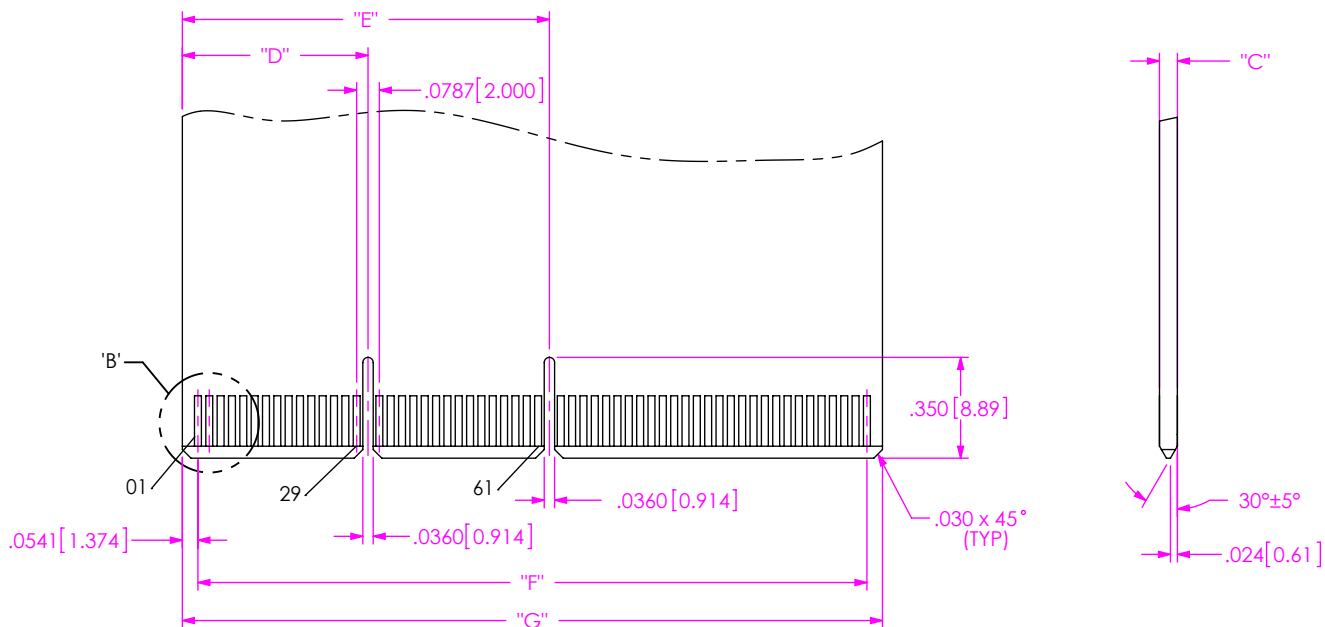
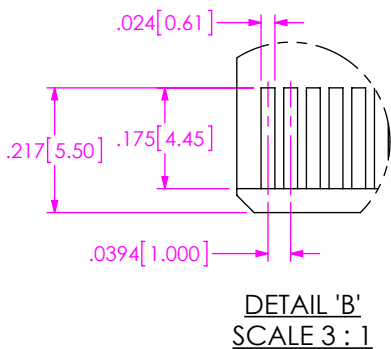

SEE NOTE 7

F:\dwg\misc\mktg\footprint\MEC1-1XX-XX-XX-D-XX-XX-FOOTPRINT.SLDDRW

PROPRIETARY NOTE



THIS DOCUMENT CONTAINS CONFIDENTIAL AND PROPRIETARY INFORMATION AND ALL DESIGN, MANUFACTURING, REPRODUCTION, USE, PATENT RIGHTS AND SALES RIGHTS ARE EXPRESSLY RESERVED BY SAMTEC, INC. THIS DOCUMENT SHALL NOT BE DISCLOSED, IN WHOLE OR PART, TO ANY UNAUTHORIZED PERSON OR ENTITY NOR REPRODUCED, TRANSFERRED OR INCORPORATED IN ANY OTHER PROJECT IN ANY MANNER WITHOUT THE EXPRESS WRITTEN CONSENT OF SAMTEC, INC.



520 PARK EAST BLVD, NEW ALBANY, IN 47150
PHONE: 812-944-6733 FAX: 812-948-5047
e-Mail info@SAMTEC.com code 55322

Looking for pricing, stock, or lifecycle information?

Click below to explore more details on WIN SOURCE:

-  [View MEC1-120-02-L-D-A-K-TR on WIN SOURCE](#)
-  [Samtec Inc. Information](#)

Optimize Your Supply Chain with WIN SOURCE Solutions

-  Global Sourcing Solution
-  Obsolete Management
-  Cost Control Management
-  Shortage Management
-  Alternative Solution
-  Excess Inventory Management