



THE DATASHEET OF
0895060.Z





Low Profile JCASE®
Cartridge Fuses

Low Profile JCASE® Cartridge Fuses Rated 58V

The Low Profile JCASE® fuse has similar performance characteristics as the standard JCASE® fuse. The lower overall height reduction allows for more space and weight savings and also allows for a shorter male blade terminal, saving additional weight and material savings in fuse box designs.

Specifications

Voltage Rating:	58 VDC
Interrupting Rating:	1000A @ 58 VDC
Recommended Environmental Temperature:	-40°C to + 125°C
Housing Material:	PA66-GF13 (U.L. 94 Flammability rating – HB)
Cover Material:	PSU (U.L. 94 Flammability rating – HB)
New Weight Per Fuse:	2.4g ±10%
Insertion Force:	53N Max. (12 lb.)
Extraction Force:	9N Min (2 lb.)
Complies With:	SAE 2741 and ISO 8820-4 except for the life test – LF specification is 100-hours at 100% of rated current

RoHS

Time-Current Characteristic Curves

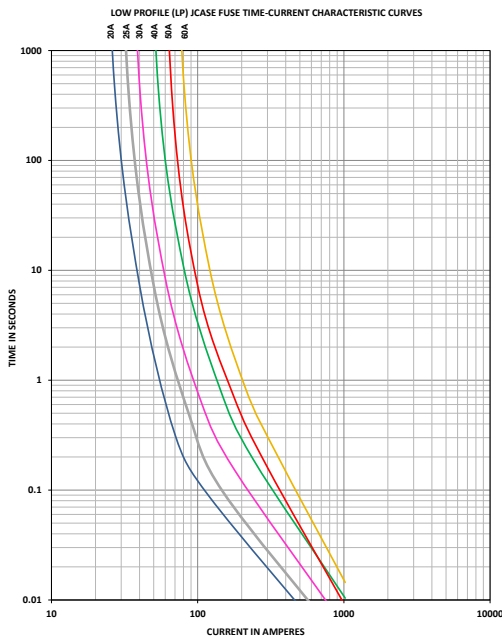

Ordering Information

Part Number	Rating	Package Size
0895xxx.Z	20 - 60	2000
0895xxx.U	20 - 60	500
0895xxx.T	20 - 60	10

Time-Current Characteristics

% of Rating	Opening Time Min / Max (s)
100	360,000 / ∞
135	60 / 1800
200	4 / 60
350	0.2 / 7
600	0.04 / 1

Ratings

Part Number	Current Rating (A)	Housing Material Color	Test Cable Size (mm ²)	Typ. Voltage Drop (mV)	Typ. Cold Resistance (mΩ)	Typ. I ² t (A ² s)
0895020_	20	Blue	4	104	4.48	400
0895025_	25	White	4	113	3.39	680
0895030_	30	Pink	4	107	2.68	1,800
0895040_	40	Green	4	102	1.89	5,500
0895050_	50	Red	6	96	1.08	4,900
0895060_	60	Yellow	6	96	0.83	9,600

The typical I²t is an average value calculated from the breaking capacity tests by using the melting time before the arcing occurs.

REV 07272021

Littelfuse® products are not designed for, and shall not be used for, any purpose (including, without limitation, automotive, military, aerospace, medical, life-saving, life-sustaining or nuclear facility applications, devices intended for surgical implant into the body, or any other application in which the failure or lack of desired operation of the product may result in personal injury, death, or property damage) other than those expressly set forth in applicable Littelfuse® product documentation. Warranties granted by Littelfuse® shall be deemed void for products used for any purpose not expressly set forth in applicable Littelfuse® documentation. Littelfuse® shall not be liable for any claims or damages arising out of products used in applications not expressly intended by Littelfuse® as set forth in applicable Littelfuse® documentation. The sale and use of Littelfuse® products is subject to Littelfuse Terms and Conditions of Sale, unless otherwise agreed by Littelfuse®.

Low Profile JCASE® Cartridge Fuses Rated 58V

Dimensions

Dimensions in mm for reference only. See outline drawing for dimensions and tolerances.

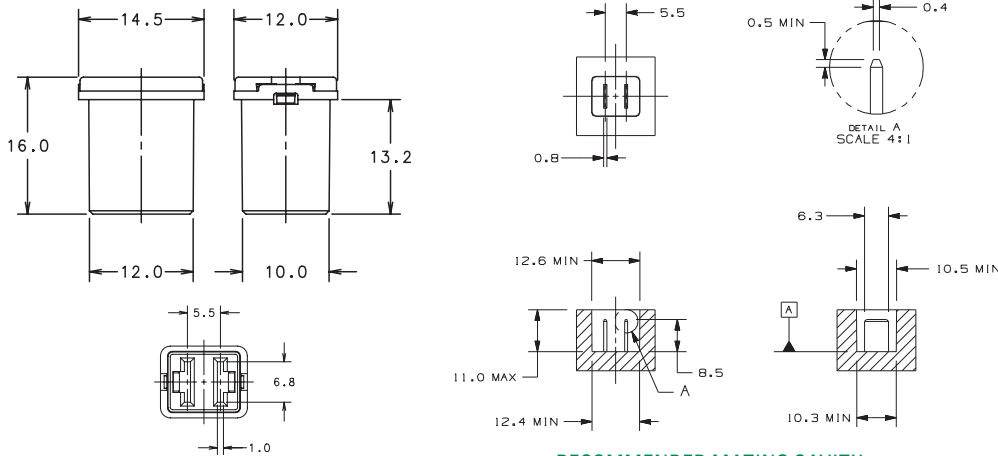

RECOMMENDED MATING CAVITY

(Please refer to the OL drawing for further details)

Typical Derating of Fuse Melting Element

Temperature Security Margin is 20%

Please Contact Littelfuse® for Details Regarding Derating Test Set-Up

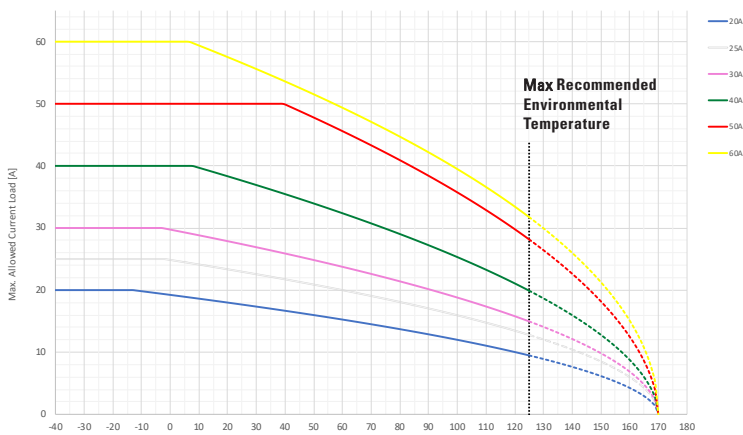

Temperature Table

	max. allowed current load [A] at ambient temperature (typical derating)						
	-40°C	0°C	20°C	65°C	85°C	110°C	125°C
20A	20	19	18	15	13	11	9
25A	25	25	23	20	18	15	13
30A	30	30	28	23	21	17	15
40A	40	40	38	32	28	23	20
50A	50	50	50	44	40	33	28
60A	60	60	58	48	43	37	32

Derating curves may change depending on the final condition of the application (terminals characteristics, wire size etc.). Please ask Littelfuse for more information.

REV 07272021

Littelfuse® products are not designed for, and shall not be used for, any purpose (including, without limitation, automotive, military, aerospace, medical, life-saving, life-sustaining or nuclear facility applications, devices intended for surgical implant into the body, or any other application in which the failure or lack of desired operation of the product may result in personal injury, death, or property damage) other than those expressly set forth in applicable Littelfuse® product documentation. Warranties granted by Littelfuse® shall be deemed void for products used for any purpose not expressly set forth in applicable Littelfuse® documentation. Littelfuse® shall not be liable for any claims or damages arising out of products used in applications not expressly intended by Littelfuse® as set forth in applicable Littelfuse® documentation. The sale and use of Littelfuse® products is subject to Littelfuse Terms and Conditions of Sale, unless otherwise agreed by Littelfuse®.

Looking for pricing, stock, or lifecycle information?

Click below to explore more details on WIN SOURCE:

 [View 0895060.Z on WIN SOURCE](#)

 [Littelfuse Inc. Information](#)

Optimize Your Supply Chain with WIN SOURCE Solutions

-  Global Sourcing Solution
-  Obsolete Management
-  Cost Control Management
-  Shortage Management
-  Alternative Solution
-  Excess Inventory Management