



THE DATASHEET OF
166.7000.5102



FKS ATO® STYLE BLADE FUSE RATED 80V



Specifications

Interrupting Rating:	1000 A @ 80 VDC
Insulating Body:	Out of thermoplastic (UL 94-V0, heat-resistant)
Cover:	Out of thermoplastic (UL 94-V0, heat-resistant) Red, not transparent
Terminals:	Blade contacts Copper alloy, gal. Sn plated Edge-protected
Complies with:	UL 248 Special Purpose Fuses
cULus Recognized:	File No. E10480

Ordering Information

Part Number	Package Size
166.7000.xxx2	500
166.7000.xxx6	100









Description

The FKS-80 is an ATO® style blade fuse rated at 80V, featuring a three part construction with copper contacts for excellent reliability in harsh environment conditions and low voltage drop. Current ratings 3A thru 30A. Filled with arc-quenching material.

Time-Current Characteristics

% of Rating	Opening Time Min / Max (s)
110	360,000 s / -
150	0.500 s / 300 s
200	0.150 s / 20 s
350	0.040 s / 0.500 s
600	0.020 s / 0.100 s

Ratings

Part Number	Current Rating	Housing Color	Typ. Voltage Drop	Cold Resistance	I ² t
166.7000.430_	3 A		145 mV	39.0 mΩ	8.10 A ² s
166.7000.440_	4 A		140 mV	29.0 mΩ	14.4 A ² s
166.7000.450_	5 A		140 mV	20.6 mΩ	24.3 A ² s
166.7000.475_	7.5 A		120 mV	11.5 mΩ	44.5 A ² s
166.7000.510_	10 A		110 mV	7.90 mΩ	86.4 A ² s
166.7000.515_	15 A		110 mV	4.60 mΩ	162 A ² s
166.7000.520_	20 A		110 mV	3.30 mΩ	475 A ² s
166.7000.525_	25 A		105 mV	2.27 mΩ	950 A ² s
166.7000.530_	30 A		100 mV	1.79 mΩ	1,500 A ² s

Corresponding holder see Section "Fuse Holders."

FKS ATO® STYLE BLADE FUSE RATED 80V



Dimensions

Dimensions in mm

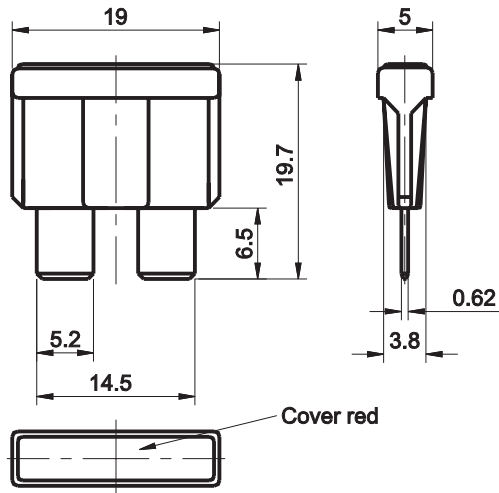

Pre-Arcing Time-Limits

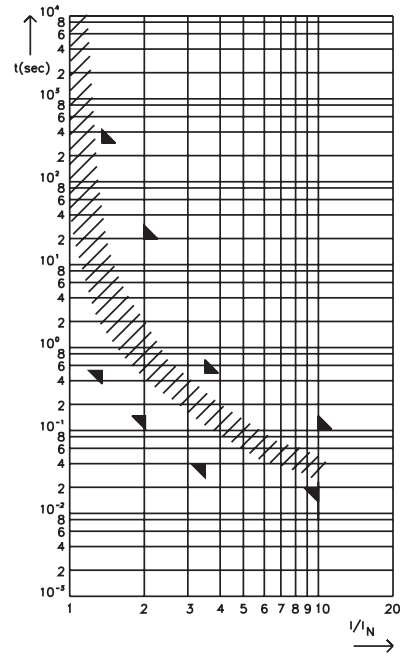

FI = 1.43 (max. operating current: $0.7 \times I_{\text{rat}}$ at 23°C)

Looking for pricing, stock, or lifecycle information?

Click below to explore more details on WIN SOURCE:

 [View 166.7000.5102 on WIN SOURCE](#)

 [Littelfuse Inc. Information](#)

Optimize Your Supply Chain with WIN SOURCE Solutions

-  Global Sourcing Solution
-  Obsolete Management
-  Cost Control Management
-  Shortage Management
-  Alternative Solution
-  Excess Inventory Management