



THE DATASHEET OF
0999070.ZXN



MAXI™ Blade Fuse Rated 58V

RoHS

Specifications

Voltage rating:	58 VDC
Interrupting Rating:	1000A @ 58 VDC
Operating Temperature Range:	-40°C to +125°C
Terminals:	Ag plated
Packaging:	









Series Serien	Pack Size
0999xxx.ZXN	1200

Same performance characteristics as the industry standard MAXI, but modified to work in the 42V environment. Rejection feature prevents lower rated fuses from being wrongfully inserted into the circuit. Backwards compatibility with 12V circuits. Based on proven technology and mates with industry standard terminals.

Gleiche Performance-Eigenschaften wie Standard-MAXI-Sicherung, jedoch für Betrieb in 42V Systemen modifiziert. Sperrfunktion verhindert versehentliche Verwendung von Sicherungen mit niedrigerer Nennspannung. Abwärtskompatibel mit 12V Schaltkreisen. Bewährte Technologie. Für Anschlüsse nach Industriestandard ausgelegt.

Time-Current Characteristics / Schmelzeit-Grenzwerte

% of Rating % des Nennstromes	Opening Time Min / Max (s) Schmelzcharakteristik Min / Max (s)
110	360,000 s / –
135	60 s / 1,800 s
200	2 s / 60 s
350	0.20 s / 7 s
600	0.040 s / 1 s

Part Number Artikel-Nr.	Current Rating Nennstrom	Housing Color Kennfarbe	Typ. Voltage Drop Typ. Spannungsfall	Cold Resistance Kaltwiderstand	I ² t
0999020_	20 A		76 mV	3.10 mΩ	1100 A ² s
0999025_	25 A		75 mV	2.39 mΩ	2087 A ² s
0999030_	30 A		77 mV	1.95 mΩ	4070 A ² s
0999035_	35 A		75 mV	1.71 mΩ	6032 A ² s
0999040_	40 A		75 mV	1.42 mΩ	8450 A ² s
0999050_	50 A		70 mV	1.10 mΩ	11300 A ² s
0999060_	60 A		66 mV	0.89 mΩ	15300 A ² s
0999070_	70 A		61 mV	0.64 mΩ	6900 A ² s
0999080_	80 A		62 mV	0.54 mΩ	8800 A ² s

Corresponding holder see Section "Fuse Holders."

MAXI™ Blade Fuse Rated 58V

Dimensions in mm / Maße in mm

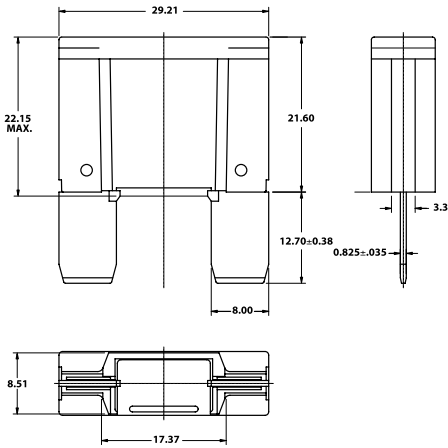

Recommended Mating Cavity

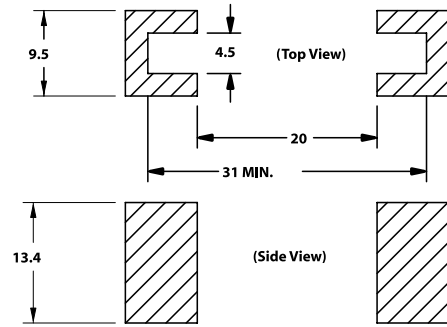

MAXI Fuse Temperature Derating Curve

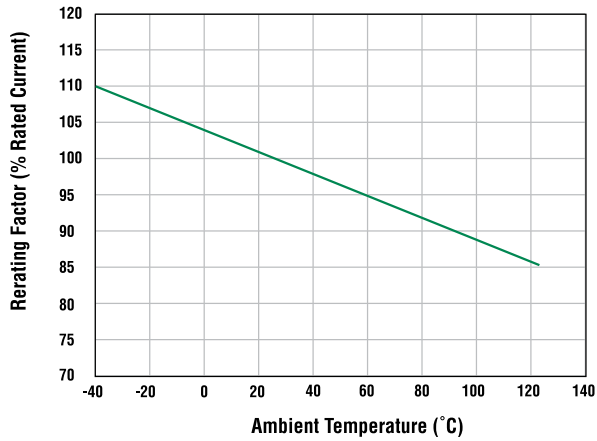

Blade Fuses

Looking for pricing, stock, or lifecycle information?

Click below to explore more details on WIN SOURCE:

 [View 0999070.ZXN on WIN SOURCE](#)

 [Littelfuse Inc. Information](#)

Optimize Your Supply Chain with WIN SOURCE Solutions

-  Global Sourcing Solution
-  Obsolete Management
-  Cost Control Management
-  Shortage Management
-  Alternative Solution
-  Excess Inventory Management