



**THE DATASHEET OF
LNY2G123MSEJ**



ALUMINUM ELECTROLYTIC CAPACITORS

nichicon

LNY

Screw Terminal Type, 85°C Higher Capacitance

- Suited for equipment down sizing.
- Load life of 2000 hours application of ripple current at 85°C
- Compliant to the RoHS directive (2011/65/EU,(EU)2015/863).

LNY

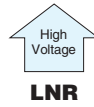

Specifications

Item	Performance Characteristics		
Category Temperature Range	- 40 to +85°C		
Rated Voltage Range	350 to 450V		
Rated Capacitance Range	820 to 22000μF		
Capacitance Tolerance	±20% (120Hz, 20°C)		
Leakage Current	After 5 minutes' application of rated voltage, leakage current is not more than $3\sqrt{C}$ (μA) or 5 mA, whichever is smaller. (at 20°C) [C: Rated Capacitance(μF), V: Voltage (V)]		
Tangent of loss angle (tan δ)	See refer to next page (Measurement frequency : 120Hz at 20°C)		
Stability at Low Temperature	Rated voltage (V)	350 to 450	
	Impedance ratio (max.)	Z(-40°C) / Z(+20°C) 12	
Measurement frequency : 120Hz			
Insulation Resistance	The insulation resistance shall be more than 100MΩ at DC 500V application between terminal and bracket.		
Voltage proof	There is no abnormality during AC 2500V 1 minute's application between terminal and bracket.		
Endurance	The specifications listed at right shall be met when the capacitors are restored to 20°C after D.C. bias plus rated ripple current is applied for 2000 hours at 85°C, the peak voltage shall not exceed the rated voltage.	Capacitance change	Within ±20% of the initial capacitance value
		tan δ	300% or less than the initial specified value
		Leakage current	Less than or equal to the initial specified value
Shelf Life	After storing the capacitors under no load at 85°C for 1000 hours and then performing voltage treatment based on JIS C 5101-4 clause 4.1 at 20°C, they shall meet the requirements listed at right.	Capacitance change	Within ±20% of the initial capacitance value
		tan δ	300% or less than the initial specified value
		Leakage current	Less than or equal to the initial specified value
Marking	Printed with white color letter on black sleeve		

Drawing

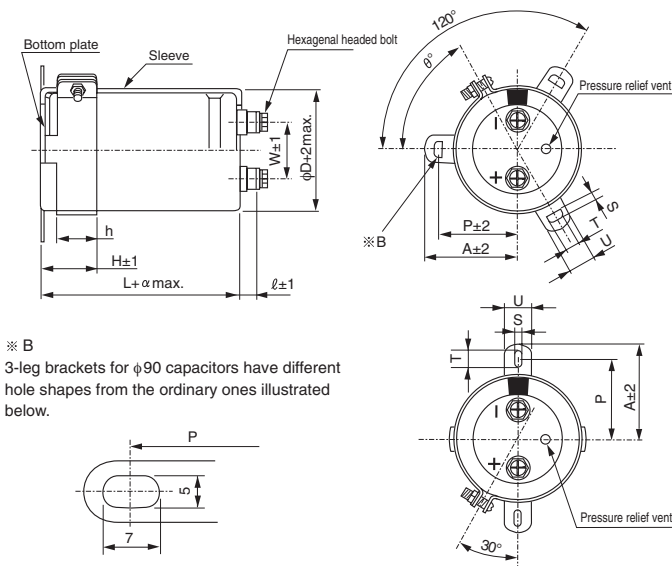

※ B
3-leg brackets for φ90 capacitors have different hole shapes from the ordinary ones illustrated below.

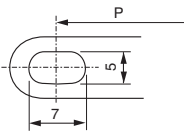

Note) The brackets will be supplied in the separate box.

Type numbering system (Example:400V 10000μF)

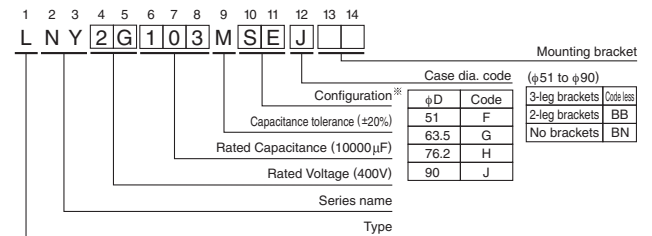

※ Configuration

Cr (III) Plating (RoHS compliant)
SE

Please refer to the Guidelines for Aluminum Electrolytic Capacitors for dimensions information.

※ Please contact to us if PVCless products are required.

● Dimension of terminal pitch (W) and length (ℓ) and Nominal dia. of bolt (mm)

φD	W	ℓ	α	Nominal dia. of bolt
51	22.0	6	3	M5
63.5	28.6	6	3	M5
76.2	31.8	6	3	M5
90	31.8	6	3	M5

● Dimension of mounting bracket (mm)

Symbol	3-Leg				2-Leg			
	51	63.5	76.2	90	51	63.5	76.2	90
P	32.5	38.1	44.5	50.8	33.2	40.5	46.5	53
A	38.5	43	49.2	58.5	40	46.5	53	59
T	7.5	8.0	7.0	8.0	6.0	7.0	6.0	6.0
S	5.0	5.0	5.0	5.0	4.5	4.5	4.5	4.5
U	12	14	14	18	14	14	14	14
θ	60	60	60	60	30	30	30	30
H	20	25	30	35	25	35	35	35
h	15	20	24	25	15	20	20	20

● Dimension table in next page.

CAT.8100M

LN_Y

■ Dimensions

350V (2V)					
Cap. (μF)	Size φD × L (mm)	Rated ripple (Arms)	tan δ	Leakage Current (mA)	Code
1500	51 × 60	9.3	0.25	2.17	LN _Y 2V152MSEF
1800	51 × 70	10.0	0.25	2.38	LN _Y 2V182MSEF
2200	51 × 80	11.1	0.25	2.63	LN _Y 2V222MSEF
2700	51 × 90	12.2	0.25	2.92	LN _Y 2V272MSEF
	63.5 × 65	11.9	0.25	2.92	LN _Y 2V272MSEG
3300	51 × 105	13.8	0.25	3.22	LN _Y 2V332MSEF
	63.5 × 75	13.1	0.25	3.22	LN _Y 2V332MSEG
3900	51 × 130	14.8	0.25	3.50	LN _Y 2V392MSEF
	63.5 × 80	14.1	0.25	3.50	LN _Y 2V392MSEG
4700	51 × 140	15.9	0.25	3.84	LN _Y 2V472MSEF
	63.5 × 90	15.8	0.25	3.84	LN _Y 2V472MSEG
	76.2 × 70	15.7	0.25	3.84	LN _Y 2V472MSEH
5600	63.5 × 100	17.1	0.25	4.20	LN _Y 2V562MSEG
	76.2 × 85	17.0	0.25	4.20	LN _Y 2V562MSEH
6800	63.5 × 125	19.2	0.25	4.62	LN _Y 2V682MSEG
	76.2 × 95	18.8	0.25	4.62	LN _Y 2V682MSEH
8200	63.5 × 145	20.6	0.25	5.00	LN _Y 2V822MSEG
	76.2 × 105	20.2	0.25	5.00	LN _Y 2V822MSEH
10000	63.5 × 165	23.2	0.25	5.00	LN _Y 2V103MSEG
	76.2 × 125	23.5	0.25	5.00	LN _Y 2V103MSEH
	90 × 95	23.5	0.25	5.00	LN _Y 2V103MSEJ
12000	76.2 × 150	24.0	0.25	5.00	LN _Y 2V123MSEH
	90 × 110	24.1	0.25	5.00	LN _Y 2V123MSEJ
15000	76.2 × 190	28.0	0.25	5.00	LN _Y 2V153MSEH
	90 × 140	29.2	0.25	5.00	LN _Y 2V153MSEJ
18000	76.2 × 210	30.2	0.25	5.00	LN _Y 2V183MSEH
	90 × 155	31.1	0.25	5.00	LN _Y 2V183MSEJ
22000	90 × 190	35.4	0.25	5.00	LN _Y 2V223MSEJ

400V (2G)					
Cap. (μF)	Size φD × L (mm)	Rated ripple (Arms)	tan δ	Leakage Current (mA)	Code
1000	51 × 60	6.4	0.25	1.89	LN _Y 2G102MSEF
1200	51 × 65	7.1	0.25	2.07	LN _Y 2G122MSEF
1500	51 × 75	8.1	0.25	2.32	LN _Y 2G152MSEF
1800	51 × 85	8.7	0.25	2.54	LN _Y 2G182MSEF
	63.5 × 65	9.1	0.25	2.54	LN _Y 2G182MSEG
2200	51 × 95	9.6	0.25	2.81	LN _Y 2G222MSEF
	63.5 × 75	10.1	0.25	2.81	LN _Y 2G222MSEG
2700	51 × 115	10.5	0.25	3.11	LN _Y 2G272MSEF
	63.5 × 85	11.6	0.25	3.11	LN _Y 2G272MSEG
3300	51 × 145	12.4	0.25	3.44	LN _Y 2G332MSEF
	63.5 × 95	13.0	0.25	3.44	LN _Y 2G332MSEG
	76.2 × 70	13.8	0.25	3.74	LN _Y 2G392MSEF
3900	63.5 × 105	14.2	0.25	3.74	LN _Y 2G392MSEG
	76.2 × 85	14.6	0.25	3.74	LN _Y 2G392MSEH
	63.5 × 125	16.1	0.25	4.11	LN _Y 2G472MSEG
4700	76.2 × 95	16.2	0.25	4.11	LN _Y 2G472MSEH
	63.5 × 140	16.9	0.25	4.48	LN _Y 2G562MSEG
5600	76.2 × 105	17.6	0.25	4.48	LN _Y 2G562MSEH
	63.5 × 165	19.1	0.25	4.94	LN _Y 2G682MSEG
8200	63.5 × 210	21.2	0.25	5.00	LN _Y 2G822MSEG
	76.2 × 150	21.2	0.25	5.00	LN _Y 2G822MSEH
	90 × 120	21.0	0.25	5.00	LN _Y 2G822MSEJ
10000	76.2 × 170	22.4	0.25	5.00	LN _Y 2G103MSEH
	90 × 130	22.0	0.25	5.00	LN _Y 2G103MSEJ
12000	76.2 × 220	26.0	0.25	5.00	LN _Y 2G123MSEH
	90 × 155	26.0	0.25	5.00	LN _Y 2G123MSEJ
15000	90 × 190	28.3	0.25	5.00	LN _Y 2G153MSEJ
18000	90 × 230	30.6	0.25	5.00	LN _Y 2G183MSEJ

450V (2W)					
Cap. (μF)	Size φD × L (mm)	Rated ripple (Arms)	tan δ	Leakage Current (mA)	Code
820	51 × 60	4.9	0.25	1.82	LN _Y 2W821MSEF
1000	51 × 70	5.5	0.25	2.01	LN _Y 2W102MSEF
1200	51 × 75	6.0	0.25	2.20	LN _Y 2W122MSEF
1500	51 × 85	6.8	0.25	2.46	LN _Y 2W152MSEF
	63.5 × 65	7.9	0.25	2.46	LN _Y 2W152MSEG
1800	51 × 95	7.9	0.25	2.70	LN _Y 2W182MSEF
	63.5 × 75	8.9	0.25	2.70	LN _Y 2W182MSEG
2200	51 × 125	9.2	0.25	2.98	LN _Y 2W222MSEF
	63.5 × 85	9.8	0.25	2.98	LN _Y 2W222MSEG
2700	51 × 145	10.3	0.25	3.30	LN _Y 2W272MSEF
	63.5 × 90	10.8	0.25	3.30	LN _Y 2W272MSEG
3300	51 × 170	11.1	0.25	3.65	LN _Y 2W332MSEF
	63.5 × 105	12.0	0.25	3.65	LN _Y 2W332MSEG
	76.2 × 85	12.6	0.25	3.65	LN _Y 2W332MSEH
3900	63.5 × 125	13.5	0.25	3.97	LN _Y 2W392MSEG
	76.2 × 95	14.0	0.25	3.97	LN _Y 2W392MSEH
4700	63.5 × 145	15.2	0.25	4.36	LN _Y 2W472MSEG
	76.2 × 105	15.6	0.25	4.36	LN _Y 2W472MSEH
5600	63.5 × 165	17.0	0.25	4.76	LN _Y 2W562MSEG
	76.2 × 125	17.6	0.25	4.76	LN _Y 2W562MSEH
6800	63.5 × 210	19.1	0.25	5.00	LN _Y 2W682MSEG
	76.2 × 150	19.6	0.25	5.00	LN _Y 2W682MSEH
	90 × 120	19.5	0.25	5.00	LN _Y 2W682MSEJ
8200	76.2 × 170	20.1	0.25	5.00	LN _Y 2W822MSEH
	90 × 130	20.1	0.25	5.00	LN _Y 2W822MSEJ
10000	76.2 × 210	23.0	0.25	5.00	LN _Y 2W103MSEH
	90 × 155	22.9	0.25	5.00	LN _Y 2W103MSEJ
12000	90 × 190	26.0	0.25	5.00	LN _Y 2W123MSEJ
15000	90 × 220	29.6	0.25	5.00	LN _Y 2W153MSEJ



● Frequency coefficient of rated ripple current

Frequency (Hz)	50	60	120	360	1k	10k or more
Coefficient	0.80	0.82	1.00	1.20	1.35	1.40

Rated ripple current (Arms) at 85°C 120Hz

Looking for pricing, stock, or lifecycle information?

Click below to explore more details on WIN SOURCE:

-  [View LNY2G123MSEJ on WIN SOURCE](#)
-  [Nichicon Information](#)

Optimize Your Supply Chain with WIN SOURCE Solutions

-  Global Sourcing Solution
-  Obsolete Management
-  Cost Control Management
-  Shortage Management
-  Alternative Solution
-  Excess Inventory Management