



# THE DATASHEET OF TLC2262QD



- Output Swing includes Both Supply Rails
- Low Noise . . . 12 nV/√Hz Typ at f = 1 kHz
- Low Input Bias Current . . . 1 pA Typ
- Fully Specified for Both Single-Supply and Split-Supply Operation
- Low Power . . . 500 μA Max
- Common-Mode Input Voltage Range Includes Negative Rail
- Low Input Offset Voltage  
950 μV Max at T<sub>A</sub> = 25°C (TLC2262A)
- Macromodel Included
- Performance Upgrade for the TS27M2/M4 and TLC27M2/M4
- Available in Q-Temp Automotive HighRel Automotive Applications Configuration Control/Print Support Qualification to Automotive Standards

## description

The TLC2262 and TLC2264 are dual and quadruple operational amplifiers from Texas Instruments. Both devices exhibit rail-to-rail output performance for increased dynamic range in single- or split-supply applications. The TLC226x family offers a compromise between the micropower TLC225x and the ac performance of the TLC227x. It has low supply current for battery-powered applications, while still having adequate ac performance for applications that demand it. The noise performance has been dramatically improved over previous generations of CMOS amplifiers. Figure 1 depicts the low level of noise voltage for this CMOS amplifier, which has only 200 μA (typ) of supply current per amplifier.

The TLC226x, exhibiting high input impedance and low noise, are excellent for small-signal conditioning for high-impedance sources, such as piezoelectric transducers. Because of the micro-power dissipation levels, these devices work well in hand-held monitoring and remote-sensing applications. In addition, the rail-to-rail output feature with single or split supplies makes this family a great choice when interfacing with analog-to-digital converters (ADCs). For precision applications, the TLC226xA family is available and has a maximum input offset voltage of 950 μV. This family is fully characterized at 5 V and ±5 V.

The TLC2262/4 also makes great upgrades to the TLC27M2/L4 or TS27M2/L4 in standard designs. They offer increased output dynamic range, lower noise voltage and lower input offset voltage. This enhanced feature set allows them to be used in a wider range of applications. For applications that require higher output drive and wider input voltage range, see the TLV2432 and TLV2442. If your design requires single amplifiers, please see the TLV2211/21/31 family. These devices are single rail-to-rail operational amplifiers in the SOT-23 package. Their small size and low power consumption, make them ideal for high density, battery-powered equipment.

EQUIVALENT INPUT NOISE VOLTAGE  
vs  
FREQUENCY

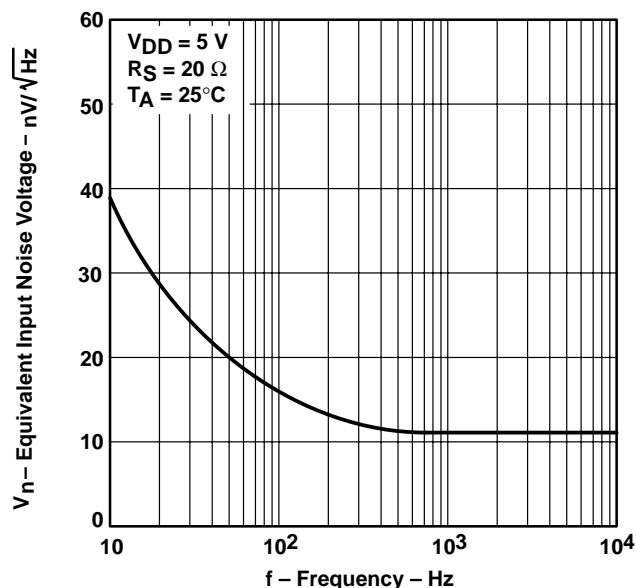

Figure 1



Please be aware that an important notice concerning availability, standard warranty, and use in critical applications of Texas Instruments semiconductor products and disclaimers thereto appears at the end of this data sheet.

Advanced LinCMOS is a trademark of Texas Instruments.

PRODUCTION DATA information is current as of publication date. Products conform to specifications per the terms of Texas Instruments standard warranty. Production processing does not necessarily include testing of all parameters.

 **TEXAS  
INSTRUMENTS**

POST OFFICE BOX 655303 • DALLAS, TEXAS 75265

Copyright © 2001, Texas Instruments Incorporated  
On products compliant to MIL-PRF-38535, all parameters are tested unless otherwise noted. On all other products, production processing does not necessarily include testing of all parameters.

# TLC226x, TLC226xA

## Advanced LinCMOS™ RAIL-TO-RAIL OPERATIONAL AMPLIFIERS

SLOS177D – FEBRUARY 1997 – REVISED MARCH 2001

### TLC2262 AVAILABLE OPTIONS

| T <sub>A</sub> | V <sub>IO</sub> max<br>AT 25°C | PACKAGED DEVICES        |                           |                           |                         |                  |                            |
|----------------|--------------------------------|-------------------------|---------------------------|---------------------------|-------------------------|------------------|----------------------------|
|                |                                | SMALL<br>OUTLINE<br>(D) | CHIP<br>CARRIER<br>(FK)   | CERAMIC<br>DIP<br>(JG)    | PLASTIC<br>DIP<br>(P)   | TSSOP<br>(PW)    | CERAMIC<br>FLATPACK<br>(U) |
| 0°C to 70°C    | 2.5 mV                         | TLC2262CD               | —                         | —                         | TLC2262CP               | TLC2262CPW       | —                          |
| –40°C to 125°C | 950 μV<br>2.5 mV               | TLC2262AID<br>TLC2262ID | —<br>—                    | —<br>—                    | TLC2262AIP<br>TLC2262IP | TLC2262AIPW<br>— | —<br>—                     |
| –40°C to 125°C | 950 μV<br>2.5 mV               | TLC2262AQD<br>TLC2262QD | —<br>—                    | —<br>—                    | —<br>—                  | —<br>—           | —<br>—                     |
| –55°C to 125°C | 950 μV<br>2.5 mV               | —<br>—                  | TLC2262AMFK<br>TLC2262MFK | TLC2262AMJG<br>TLC2262MJG | —<br>—                  | —<br>—           | TLC2262AMU<br>TLC2262MU    |

The D packages are available taped and reeled. Add R suffix to device type (e.g., TLC2262CDR). The PW package is available only left-end taped and reeled. Chips are tested at 25°C.

### TLC2264 AVAILABLE OPTIONS

| T <sub>A</sub> | V <sub>IO</sub> max<br>AT 25°C | PACKAGED DEVICES        |                           |                         |                         |                  |                            |
|----------------|--------------------------------|-------------------------|---------------------------|-------------------------|-------------------------|------------------|----------------------------|
|                |                                | SMALL<br>OUTLINE<br>(D) | CHIP<br>CARRIER<br>(FK)   | CERAMIC<br>DIP<br>(J)   | PLASTIC<br>DIP<br>(N)   | TSSOP<br>(PW)    | CERAMIC<br>FLATPACK<br>(W) |
| 0°C to 70°C    | 2.5 mV                         | TLC2264CD               | —                         | —                       | TLC2264CN               | TLC2264CPW       | —                          |
| –40°C to 125°C | 950 μV<br>2.5 mV               | TLC2264AID<br>TLC2264ID | —<br>—                    | —<br>—                  | TLC2264AIN<br>TLC2264IN | TLC2264AIPW<br>— | —<br>—                     |
| –40°C to 125°C | 950 μV<br>2.5 mV               | TLC2264AQD<br>TLC2264QD | —<br>—                    | —<br>—                  | —<br>—                  | —<br>—           | —<br>—                     |
| –55°C to 125°C | 950 μV<br>2.5 mV               | —<br>—                  | TLC2264AMFK<br>TLC2264MFK | TLC2264AMJ<br>TLC2264MJ | —<br>—                  | —<br>—           | TLC2264AMW<br>TLC2264MW    |

The D packages are available taped and reeled. Add R suffix to device type (e.g., TLC2264CDR). The PW package is available only left-end taped and reeled. Chips are tested at 25°C.



# TLC226x, TLC226xA Advanced LinCMOS™ RAIL-TO-RAIL OPERATIONAL AMPLIFIERS

SLOS177D – FEBRUARY 1997 – REVISED MARCH 2001

**TLC2262C, TLC2262AC  
TLC2262I, TLC2262AI  
TLC2262Q, TLC2262AQ  
D, P, OR PW PACKAGE  
(TOP VIEW)**

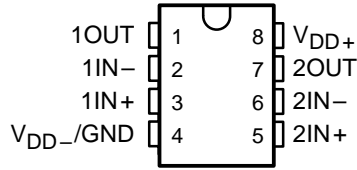

**TLC2262M, TLC2262AM ... FK PACKAGE  
(TOP VIEW)**



NC – No internal connection

**TLC2262M, TLC2262AM ... JG PACKAGE  
(TOP VIEW)**

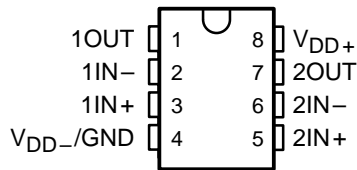

**TLC2262M, TLC2262AM ... U PACKAGE  
(TOP VIEW)**

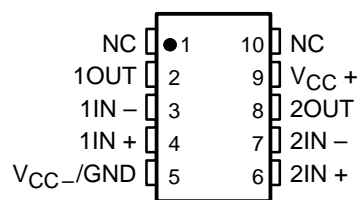

NC – No internal connection

**TLC2264C, TLC2264AC  
TLC2264I, TLC2264AI  
TLC2264Q, TLC2264AQ  
D, N, OR PW PACKAGE  
(TOP VIEW)**



**TLC2264M, TLC2264AM ... J OR W PACKAGE  
(TOP VIEW)**



**TLC2264M, TLC2264AM ... FK PACKAGE  
(TOP VIEW)**



NC – No internal connection

**TLC226x, TLC226xA**  
**Advanced LinCMOS™ RAIL-TO-RAIL**  
**OPERATIONAL AMPLIFIERS**

SLOS177D – FEBRUARY 1997 – REVISED MARCH 2001

equivalent schematic (each amplifier)



| ACTUAL DEVICE COMPONENT COUNT† |         |         |
|--------------------------------|---------|---------|
| COMPONENT                      | TLC2262 | TLC2264 |
| Transistors                    | 38      | 76      |
| Resistors                      | 28      | 56      |
| Diodes                         | 9       | 18      |
| Capacitors                     | 3       | 6       |

† Includes both amplifiers and all ESD, bias, and trim circuitry

**absolute maximum ratings over operating free-air temperature range (unless otherwise noted)†**

|  |                                |
|--|--------------------------------|
| Supply voltage, $V_{DD+}$ (see Note 1)   | 8 V                            |
| Supply voltage, $V_{DD-}$ (see Note 1)   | –8 V                           |
| Differential input voltage, $V_{ID}$ (see Note 2)                                      | ±16 V                          |
| Input voltage, $V_I$ (any input, see Note 1)   | $V_{DD-} - 0.3$ V to $V_{DD+}$ |
| Input current, $I_I$ (each input)  | ±5 mA                          |
| Output current, $I_O$  | ±50 mA                         |
| Total current into $V_{DD+}$   | ±50 mA                         |
| Total current out of $V_{DD-}$   | ±50 mA                         |
| Duration of short-circuit current at (or below) 25°C (see Note 3)                      | unlimited                      |
| Continuous total dissipation   | See Dissipation Rating Table   |
| Operating free-air temperature range, $T_A$ : C suffix                                 | 0°C to 70°C                    |
| I suffix   | –40°C to 125°C                 |
| Q suffix   | –40°C to 125°C                 |
| M suffix   | –55°C to 125°C                 |
| Storage temperature range, $T_{stg}$   | –65°C to 150°C                 |
| Lead temperature 1,6 mm (1/16 inch) from case for 10 seconds: D, N, P, and PW packages | 260°C                          |
| J, JG, U, and W packages   | 300°C                          |

† Stresses beyond those listed under “absolute maximum ratings” may cause permanent damage to the device. These are stress ratings only, and functional operation of the device at these or any other conditions beyond those indicated under “recommended operating conditions” is not implied. Exposure to absolute-maximum-rated conditions for extended periods may affect device reliability.

- NOTES: 1. All voltage values, except differential voltages, are with respect to the midpoint between  $V_{DD+}$  and  $V_{DD-}$ .  
2. Differential voltages are at  $IN+$  with respect to  $IN-$ . Excessive current flows if input is brought below  $V_{DD-} - 0.3$  V.  
3. The output may be shorted to either supply. Temperature and/or supply voltages must be limited to ensure that the maximum dissipation rating is not exceeded.

**DISSIPATION RATING TABLE**

| PACKAGE | $T_A \leq 25^\circ\text{C}$<br>POWER RATING | DERATING FACTOR<br>ABOVE $T_A = 25^\circ\text{C}$ | $T_A = 70^\circ\text{C}$<br>POWER RATING | $T_A = 85^\circ\text{C}$<br>POWER RATING | $T_A = 125^\circ\text{C}$<br>POWER RATING |
|---------|---|---|--|--|---|
| D–8     | 725 mW                                      | 5.8 mW/°C   | 464 mW                                   | 377 mW                                   | 145 mW                                    |
| D–14    | 950 mW                                      | 7.6 mW/°C   | 608 mW                                   | 494 mW                                   | 190 mW                                    |
| FK      | 1375 mW                                     | 11.0 mW/°C  | 880 mW                                   | 715 mW                                   | 275 mW                                    |
| J       | 1375 mW                                     | 11.0 mW/°C  | 880 mW                                   | 715 mW                                   | 275 mW                                    |
| JG      | 1050 mW                                     | 8.4 mW/°C   | 672 mW                                   | 546 mW                                   | 210 mW                                    |
| N       | 1150 mW                                     | 9.2 mW/°C   | 736 mW                                   | 598 mW                                   | 230 mW                                    |
| P       | 1000 mW                                     | 8.0 mW/°C   | 640 mW                                   | 520 mW                                   | 200 mW                                    |
| PW–8    | 525 mW                                      | 4.2 mW/°C   | 336 mW                                   | 273 mW                                   | 105 mW                                    |
| PW–14   | 700 mW                                      | 5.6 mW/°C   | 448 mW                                   | 364 mW                                   | 140 mW                                    |
| U       | 700 mW                                      | 5.5 mW/°C   | 452 mW                                   | 370 mW                                   | 150 mW                                    |
| W       | 700 mW                                      | 5.5 mW/°C   | 452 mW                                   | 370 mW                                   | 150 mW                                    |

**recommended operating conditions**

|                                       | C SUFFIX  |                 | I SUFFIX  |                 | Q SUFFIX  |                 | M SUFFIX  |                 | UNIT |
|---------------------------------------|-----------|-----------------|-----------|-----------------|-----------|-----------------|-----------|-----------------|------|
|                                       | MIN       | MAX             | MIN       | MAX             | MIN       | MAX             | MIN       | MAX             |      |
| Supply voltage, $V_{DD\pm}$           | ±2.2      | ±8              | ±2.2      | ±8              | ±2.2      | ±8              | ±2.2      | ±8              | V    |
| Input voltage range, $V_I$            | $V_{DD-}$ | $V_{DD+} - 1.5$ | $V_{DD-}$ | $V_{DD+} - 1.5$ | $V_{DD-}$ | $V_{DD+} - 1.5$ | $V_{DD-}$ | $V_{DD+} - 1.5$ | V    |
| Common-mode input voltage, $V_{IC}$   | $V_{DD-}$ | $V_{DD+} - 1.5$ | $V_{DD-}$ | $V_{DD+} - 1.5$ | $V_{DD-}$ | $V_{DD+} - 1.5$ | $V_{DD-}$ | $V_{DD+} - 1.5$ | V    |
| Operating free-air temperature, $T_A$ | 0         | 70              | –40       | 125             | –40       | 125             | –55       | 125             | °C   |

# TLC226x, TLC226xA Advanced LinCMOS™ RAIL-TO-RAIL OPERATIONAL AMPLIFIERS

SLOS177D – FEBRUARY 1997 – REVISED MARCH 2001

**TLC2262C electrical characteristics at specified free-air temperature,  $V_{DD} = 5\text{ V}$  (unless otherwise noted)**

| PARAMETER  | TEST CONDITIONS   | $T_A$ †  | TLC2262C   |             |                              | UNIT                                |
|--|---|--|--|-------------|------------------------------|-------------------------------------|
|  |   |  | MIN  | TYP         | MAX                          |                                     |
| $V_{IO}$ Input offset voltage  | $V_{IC} = 0,$<br>$V_O = 0,$<br>$V_{DD} \pm = \pm 2.5\text{ V},$<br>$R_S = 50\ \Omega$   | 25°C   | 300  | 2500        | $\mu\text{V}$                |                                     |
|  |   | Full range   | 3000   |             |                              |                                     |
| $\alpha_{VIO}$ Temperature coefficient of input offset voltage             |   | 25°C to 70°C   | 2  |             | $\mu\text{V}/^\circ\text{C}$ |                                     |
| Input offset voltage long-term drift (see Note 4)                          |   | 25°C   | 0.003  |             | $\mu\text{V}/\text{mo}$      |                                     |
| $I_{IO}$ Input offset current  |   | 25°C   | 0.5  |             | $\text{pA}$                  |                                     |
|  |   | Full range   | 100  |             |                              |                                     |
| $I_{IB}$ Input bias current  | 25°C  | 1  |  | $\text{pA}$ |                              |                                     |
|  | Full range  | 100  |  |             |                              |                                     |
| $V_{ICR}$ Common-mode input voltage range                                  | $R_S = 50\ \Omega,$<br>$ V_{IO}  \leq 5\text{ mV}$  | 25°C   | 0 to 4   | -0.3 to 4.2 | V                            |                                     |
|  |   | Full range   | 0 to 3.5   |             |                              |                                     |
| $V_{OH}$ High-level output voltage   | $I_{OH} = -20\ \mu\text{A}$<br>$I_{OH} = -100\ \mu\text{A}$<br>$I_{OH} = -400\ \mu\text{A}$   | 25°C   | 4.99   |             | V                            |                                     |
|  |   | 25°C   | 4.85   | 4.94        |                              |                                     |
|  |   | Full range   | 4.82   |             |                              |                                     |
|  |   | 25°C   | 4.70   | 4.85        |                              |                                     |
| $V_{OL}$ Low-level output voltage  | $V_{IC} = 2.5\text{ V},$<br>$I_{OL} = 50\ \mu\text{A}$<br>$I_{OL} = 500\ \mu\text{A}$<br>$I_{OL} = 1\text{ mA}$<br>$I_{OL} = 4\text{ mA}$ | 25°C   | 0.01   |             | V                            |                                     |
|  |   | 25°C   | 0.09   | 0.15        |                              |                                     |
|  |   | Full range   | 0.15   |             |                              |                                     |
|  |   | 25°C   | 0.2  | 0.3         |                              |                                     |
|  |   | Full range   | 0.3  |             |                              |                                     |
|  |   | 25°C   | 0.7  | 1           |                              |                                     |
|  |   | Full range   | 1.2  |             |                              |                                     |
|  |   | $A_{VD}$ Large-signal differential voltage amplification | $V_{IC} = 2.5\text{ V},$<br>$V_O = 1\text{ V to }4\text{ V}$ | 25°C        |                              | $R_L = 50\ \text{k}\Omega^\ddagger$ |
| Full range   |   |  |  |             |                              |                                     |
| 25°C   | $R_L = 1\ \text{M}\Omega^\ddagger$  |  |  |             |                              |                                     |
| $r_{i(d)}$ Differential input resistance                                   |   | 25°C   | $10^{12}$  |             | $\Omega$                     |                                     |
| $r_{i(c)}$ Common-mode input resistance                                    |   | 25°C   | $10^{12}$  |             | $\Omega$                     |                                     |
| $c_{i(c)}$ Common-mode input capacitance                                   | $f = 10\text{ kHz},$ P package  | 25°C   | 8  |             | pF                           |                                     |
| $z_o$ Closed-loop output impedance   | $f = 100\text{ kHz},$ $A_V = 10$  | 25°C   | 240  |             | $\Omega$                     |                                     |
| CMRR Common-mode rejection ratio   | $V_{IC} = 0\text{ to }2.7\text{ V},$ $V_O = 2.5\text{ V},$<br>$R_S = 50\ \Omega$  | 25°C   | 70   | 83          | dB                           |                                     |
|  |   | Full range   | 70   |             |                              |                                     |
| $k_{SVR}$ Supply-voltage rejection ratio ( $\Delta V_{DD}/\Delta V_{IO}$ ) | $V_{DD} = 4.4\text{ V to }16\text{ V},$<br>$V_{IC} = V_{DD}/2,$ No load   | 25°C   | 80   | 95          | dB                           |                                     |
|  |   | Full range   | 80   |             |                              |                                     |
| $I_{DD}$ Supply current  | $V_O = 2.5\text{ V},$ No load   | 25°C   | 400  | 500         | $\mu\text{A}$                |                                     |
|  |   | Full range   | 500  |             |                              |                                     |

† Full range is 0°C to 70°C.

‡ Referenced to 2.5 V

NOTE 4: Typical values are based on the input offset voltage shift observed through 500 hours of operating life test at  $T_A = 150^\circ\text{C}$  extrapolated to  $T_A = 25^\circ\text{C}$  using the Arrhenius equation and assuming an activation energy of 0.96 eV.



**TLC2262C operating characteristics at specified free-air temperature,  $V_{DD} = 5\text{ V}$**

| PARAMETER   |   | TEST CONDITIONS  |                                      | $T_A$ †    | TLC2262C   |       |                        | UNIT |
|-------------|---|--|--------------------------------------|------------|------------|-------|------------------------|------|
|             |   |  |                                      |            | MIN        | TYP   | MAX                    |      |
| SR          | Slew rate at unity gain                     | $V_O = 1.5\text{ V to }3.5\text{ V},$<br>$C_L = 100\text{ pF}‡$                                | $R_L = 50\text{ k}\Omega‡$           | 25°C       | 0.35       | 0.55  | V/ $\mu\text{s}$       |      |
|             |   |  |                                      | Full range | 0.3        |       |                        |      |
| $V_n$       | Equivalent input noise voltage              | $f = 10\text{ Hz}$   | $f = 1\text{ kHz}$                   | 25°C       | 40         |       | nV/ $\sqrt{\text{Hz}}$ |      |
|             |   |  |                                      | 25°C       | 12         |       |                        |      |
| $V_{N(PP)}$ | Peak-to-peak equivalent input noise voltage | $f = 0.1\text{ Hz to }1\text{ Hz}$   | $f = 0.1\text{ Hz to }10\text{ Hz}$  | 25°C       | 0.7        |       | $\mu\text{V}$          |      |
|             |   |  |                                      | 25°C       | 1.3        |       |                        |      |
| $I_n$       | Equivalent input noise current              |  |                                      | 25°C       | 0.6        |       | fA/ $\sqrt{\text{Hz}}$ |      |
| THD + N     | Total harmonic distortion plus noise        | $V_O = 0.5\text{ V to }2.5\text{ V},$<br>$f = 20\text{ kHz},$<br>$R_L = 50\text{ k}\Omega‡$    | $A_V = 1$                            | 25°C       | 0.017%     |       |                        |      |
|             |   |  |                                      |            | $A_V = 10$ | 0.03% |                        |      |
|             | Gain-bandwidth product                      | $f = 10\text{ kHz},$<br>$C_L = 100\text{ pF}‡$   | $R_L = 50\text{ k}\Omega‡$           | 25°C       | 0.71       |       | MHz                    |      |
| BOM         | Maximum output-swing bandwidth              | $V_{O(PP)} = 2\text{ V},$<br>$R_L = 50\text{ k}\Omega‡$  | $A_V = 1,$<br>$C_L = 100\text{ pF}‡$ | 25°C       | 185        |       | kHz                    |      |
| $t_s$       | Settling time                               | $A_V = -1,$<br>Step = 0.5 V to 2.5 V,<br>$R_L = 50\text{ k}\Omega‡,$<br>$C_L = 100\text{ pF}‡$ | To 0.1%                              | 25°C       | 6.4        |       | $\mu\text{s}$          |      |
|             |   |  | To 0.01%                             |            | 14.1       |       |                        |      |
| $\phi_m$    | Phase margin at unity gain                  | $R_L = 50\text{ k}\Omega‡,$  | $C_L = 100\text{ pF}‡$               | 25°C       | 56°        |       |                        |      |
|             | Gain margin                                 |  |                                      | 25°C       | 11         |       | dB                     |      |

† Full range is 0°C to 70°C.

‡ Referenced to 2.5 V

**TLC226x, TLC226xA**  
**Advanced LinCMOS™ RAIL-TO-RAIL**  
**OPERATIONAL AMPLIFIERS**

SLOS177D – FEBRUARY 1997 – REVISED MARCH 2001

**TLC2262C electrical characteristics at specified free-air temperature,  $V_{DD\pm} = \pm 5\text{ V}$  (unless otherwise specified)**

| PARAMETER   | TEST CONDITIONS  | T <sub>A</sub> †                                | TLC2262C   |                  |             | UNIT  |
|---|--|---|------------|------------------|-------------|-------|
|   |  |   | MIN        | TYP              | MAX         |       |
| V <sub>IO</sub> Input offset voltage  | V <sub>IC</sub> = 0, V <sub>O</sub> = 0,<br>R <sub>S</sub> = 50 Ω            | 25°C  |            | 300              | 2500        | μV    |
|   |  | Full range                                      |            |                  | 3000        |       |
| αV <sub>IO</sub> Temperature coefficient of input offset voltage                        |  | 25°C to 70°C                                    |            | 2                |             | μV/°C |
| Input offset voltage long-term drift (see Note 4)                                       |  | 25°C  |            | 0.003            |             | μV/mo |
| I <sub>IO</sub> Input offset current  |  | 25°C  |            | 0.5              |             | pA    |
|   |  | Full range                                      |            |                  | 100         |       |
| I <sub>IB</sub> Input bias current  |  | 25°C  |            | 1                |             | pA    |
|   |  | Full range                                      |            |                  | 100         |       |
| V <sub>ICR</sub> Common-mode input voltage range  |  | V <sub>IO</sub>   ≤ 5 mV, R <sub>S</sub> = 50 Ω | 25°C       | -5 to 4          | -5.3 to 4.2 | V     |
|   |  |   | Full range | -5 to 3.5        |             |       |
| V <sub>OM+</sub> Maximum positive peak output voltage                                   | I <sub>O</sub> = -20 μA  | 25°C  |            | 4.99             | V           |       |
|   | I <sub>O</sub> = -100 μA   | 25°C  | 4.85       | 4.94             |             |       |
|   |  | Full range                                      | 4.82       |                  |             |       |
|   | I <sub>O</sub> = -400 μA   | 25°C  | 4.7        | 4.85             |             |       |
| Full range  |  | 4.6   |            |                  |             |       |
| V <sub>OM-</sub> Maximum negative peak output voltage                                   | V <sub>IC</sub> = 0, I <sub>O</sub> = 50 μA                                  | 25°C  |            | -4.99            | V           |       |
|   |  | 25°C  | -4.85      | -4.91            |             |       |
|   | V <sub>IC</sub> = 0, I <sub>O</sub> = 500 μA                                 | Full range                                      | -4.85      |                  |             |       |
|   |  | 25°C  | -4.7       | -4.8             |             |       |
|   | V <sub>IC</sub> = 0, I <sub>O</sub> = 1 mA                                   | Full range                                      | -4.7       |                  |             |       |
|   |  | 25°C  | -4         | -4.3             |             |       |
| V <sub>IC</sub> = 0, I <sub>O</sub> = 4 mA  | Full range   | -3.8  |            |                  |             |       |
|   |  |   |            |                  |             |       |
| A <sub>VD</sub> Large-signal differential voltage amplification                         | V <sub>O</sub> = ±4 V  | R <sub>L</sub> = 50 kΩ                          | 25°C       | 80               | 200         | V/mV  |
|   |  |   | Full range | 55               |             |       |
|   |  | R <sub>L</sub> = 1 MΩ                           | 25°C       |                  | 1000        |       |
| r <sub>i(d)</sub> Differential input resistance   |  | 25°C  |            | 10 <sup>12</sup> | Ω           |       |
| r <sub>i(c)</sub> Common-mode input resistance  |  | 25°C  |            | 10 <sup>12</sup> | Ω           |       |
| c <sub>i(c)</sub> Common-mode input capacitance   | f = 10 kHz, P package  | 25°C  |            | 8                | pF          |       |
| z <sub>o</sub> Closed-loop output impedance   | f = 100 kHz, A <sub>V</sub> = 10   | 25°C  |            | 220              | Ω           |       |
| CMRR Common-mode rejection ratio  | V <sub>IC</sub> = -5 V to 2.7 V, V <sub>O</sub> = 0 V, R <sub>S</sub> = 50 Ω | 25°C  | 75         | 88               | dB          |       |
|   |  | Full range                                      | 75         |                  |             |       |
| k <sub>SVR</sub> Supply-voltage rejection ratio (ΔV <sub>DD±</sub> / ΔV <sub>IO</sub> ) | V <sub>DD±</sub> = 2.2 V to ±8 V, V <sub>IC</sub> = 0, No load               | 25°C  | 80         | 95               | dB          |       |
|   |  | Full range                                      | 80         |                  |             |       |
| I <sub>DD</sub> Supply current  | V <sub>O</sub> = 0 V, No load  | 25°C  | 425        | 500              | μA          |       |
|   |  | Full range                                      |            | 500              |             |       |

† Full range is 0°C to 70°C.

NOTE 4: Typical values are based on the input offset voltage shift observed through 500 hours of operating life test at T<sub>A</sub> = 150°C extrapolated to T<sub>A</sub> = 25°C using the Arrhenius equation and assuming an activation energy of 0.96 eV.



**TLC226x, TLC226xA**  
**Advanced LinCMOS™ RAIL-TO-RAIL**  
**OPERATIONAL AMPLIFIERS**

SLOS177D – FEBRUARY 1997 – REVISED MARCH 2001

**TLC2262C operating characteristics at specified free-air temperature,  $V_{DD\pm} = \pm 5\text{ V}$**

| PARAMETER              |   | TEST CONDITIONS  |                                      | $T_A$ †    | TLC2262C   |        |                              | UNIT          |
|------------------------|---|--|--------------------------------------|------------|------------|--------|------------------------------|---------------|
|                        |   |  |                                      |            | MIN        | TYP    | MAX                          |               |
| SR                     | Slew rate at unity gain                     | $V_O = \pm 1.9\text{ V}$ ,<br>$C_L = 100\text{ pF}$  | $R_L = 50\text{ k}\Omega$            | 25°C       | 0.35       | 0.55   | $\text{V}/\mu\text{s}$       |               |
|                        |   |  |                                      | Full range | 0.3        |        |                              |               |
| $V_n$                  | Equivalent input noise voltage              |  |                                      | 25°C       | 43         |        | $\text{nV}/\sqrt{\text{Hz}}$ |               |
|                        |   |  |                                      | 25°C       | 12         |        |                              |               |
| $V_{N(PP)}$            | Peak-to-peak equivalent input noise voltage |  |                                      | 25°C       | 0.8        |        | $\mu\text{V}$                |               |
|                        |   |  |                                      | 25°C       | 1.3        |        |                              |               |
| $I_n$                  | Equivalent input noise current              |  |                                      | 25°C       | 0.6        |        | $\text{fA}/\sqrt{\text{Hz}}$ |               |
| THD + N                | Total harmonic distortion pulse duration    | $V_O = \pm 2.3\text{ V}$ ,<br>$f = 20\text{ kHz}$ ,<br>$R_L = 50\text{ k}\Omega$                                   |                                      | 25°C       | $A_V = 1$  | 0.014% |                              |               |
|                        |   |  |                                      |            | $A_V = 10$ | 0.024% |                              |               |
| Gain-bandwidth product |   | $f = 10\text{ kHz}$ ,<br>$C_L = 100\text{ pF}$   | $R_L = 50\text{ k}\Omega$            | 25°C       | 0.73       |        | MHz                          |               |
| B <sub>OM</sub>        | Maximum output-swing bandwidth              | $V_{O(PP)} = 4.6\text{ V}$ ,<br>$R_L = 50\text{ k}\Omega$ ,  | $A_V = 1$ ,<br>$C_L = 100\text{ pF}$ | 25°C       | 85         |        | kHz                          |               |
| $t_s$                  | Settling time                               | $A_V = -1$ ,<br>Step = $-2.3\text{ V}$ to $2.3\text{ V}$ ,<br>$R_L = 50\text{ k}\Omega$ ,<br>$C_L = 100\text{ pF}$ |                                      | 25°C       | To 0.1%    | 7.1    |                              | $\mu\text{s}$ |
|                        |   |  |                                      |            | To 0.01%   | 16.5   |                              |               |
| $\phi_m$               | Phase margin at unity gain                  | $R_L = 50\text{ k}\Omega$ ,  | $C_L = 100\text{ pF}$                | 25°C       | 57°        |        |                              |               |
|                        | Gain margin                                 |  |                                      | 25°C       | 11         |        |                              | dB            |

† Full range is 0°C to 70°C.

# TLC226x, TLC226xA Advanced LinCMOS™ RAIL-TO-RAIL OPERATIONAL AMPLIFIERS

SLOS177D – FEBRUARY 1997 – REVISED MARCH 2001

**TLC2264C electrical characteristics at specified free-air temperature,  $V_{DD} = 5\text{ V}$  (unless otherwise noted)**

| PARAMETER   | TEST CONDITIONS  | $T_A$ †                            | TLC2264C   |             |                              | UNIT                 |
|---|--|------------------------------------|------------|-------------|------------------------------|----------------------|
|   |  |                                    | MIN        | TYP         | MAX                          |                      |
| $V_{IO}$ Input offset voltage   | $V_{IC} = 0,$<br>$V_O = 0,$<br>$V_{DD\pm} = \pm 2.5\text{ V},$<br>$R_S = 50\ \Omega$ | 25°C                               | 300        | 2500        | $\mu\text{V}$                |                      |
|   |  | Full range                         | 3000       |             |                              |                      |
| $\alpha_{VIO}$ Temperature coefficient of input offset voltage        |  | 25°C to 70°C                       | 2          |             | $\mu\text{V}/^\circ\text{C}$ |                      |
| Input offset voltage long-term drift (see Note 4)                     |  | 25°C                               | 0.003      |             | $\mu\text{V}/\text{mo}$      |                      |
| $I_{IO}$ Input offset current   |  | 25°C                               | 0.5        |             | $\text{pA}$                  |                      |
|   |  | Full range                         | 100        |             |                              |                      |
| $I_{IB}$ Input bias current   | 25°C   | 1                                  |            | $\text{pA}$ |                              |                      |
|   | Full range   | 100                                |            |             |                              |                      |
| $V_{ICR}$ Common-mode input voltage range                             | $R_S = 50\ \Omega,$<br>$ V_{IO}  \leq 5\text{ mV}$                                   | 25°C                               | 0 to 4     | -0.3 to 4.2 | $\text{V}$                   |                      |
|   |  | Full range                         | 0 to 3.5   |             |                              |                      |
| $V_{OH}$ High-level output voltage                                    | $I_{OH} = -20\ \mu\text{A}$  | 25°C                               | 4.99       |             | $\text{V}$                   |                      |
|   | $I_{OH} = -100\ \mu\text{A}$   | 25°C                               | 4.85       | 4.94        |                              |                      |
|   | $I_{OH} = -400\ \mu\text{A}$   | Full range                         | 4.82       |             |                              |                      |
|   |  | 25°C                               | 4.70       | 4.85        |                              |                      |
| $V_{OL}$ Low-level output voltage                                     | $V_{IC} = 2.5\text{ V},$<br>$I_{OL} = 50\ \mu\text{A}$                               | 25°C                               | 0.01       |             | $\text{V}$                   |                      |
|   |  | Full range                         | 0.09       | 0.15        |                              |                      |
|   | $V_{IC} = 2.5\text{ V},$<br>$I_{OL} = 500\ \mu\text{A}$                              | 25°C                               | 0.09       |             |                              |                      |
|   |  | Full range                         | 0.15       |             |                              |                      |
|   | $V_{IC} = 2.5\text{ V},$<br>$I_{OL} = 1\text{ mA}$                                   | 25°C                               | 0.2        | 0.3         |                              |                      |
|   |  | Full range                         | 0.3        |             |                              |                      |
| $V_{IC} = 2.5\text{ V},$<br>$I_{OL} = 4\text{ mA}$                    | 25°C   | 0.7                                | 1          |             |                              |                      |
|   | Full range   | 1.2                                |            |             |                              |                      |
| $A_{VD}$ Large-signal differential voltage amplification              | $V_{IC} = 2.5\text{ V},$<br>$V_O = 1\text{ V to }4\text{ V}$                         | $R_L = 50\text{ k}\Omega^\ddagger$ | 25°C       | 80          | 170                          | $\text{V}/\text{mV}$ |
|   |  | $R_L = 1\text{ M}\Omega^\ddagger$  | Full range | 55          |                              |                      |
|   |  |                                    | 25°C       | 550         |                              |                      |
| $r_{i(d)}$ Differential input resistance                              |  | 25°C                               | $10^{12}$  |             | $\Omega$                     |                      |
| $r_{i(c)}$ Common-mode input resistance                               |  | 25°C                               | $10^{12}$  |             | $\Omega$                     |                      |
| $c_{i(c)}$ Common-mode input capacitance                              | $f = 10\text{ kHz},$<br>N package  | 25°C                               | 8          |             | $\text{pF}$                  |                      |
| $z_o$ Closed-loop output impedance                                    | $f = 100\text{ kHz},$<br>$A_V = 10$  | 25°C                               | 240        |             | $\Omega$                     |                      |
| CMRR Common-mode rejection ratio                                      | $V_{IC} = 0\text{ to }2.7\text{ V},$<br>$V_O = 2.5\text{ V},$<br>$R_S = 50\ \Omega$  | 25°C                               | 70         | 83          | $\text{dB}$                  |                      |
|   |  | Full range                         | 70         |             |                              |                      |
| kSVR Supply-voltage rejection ratio ( $\Delta V_{DD}/\Delta V_{IO}$ ) | $V_{DD} = 4.4\text{ V to }16\text{ V},$<br>$V_{IC} = V_{DD}/2,$<br>No load           | 25°C                               | 80         | 95          | $\text{dB}$                  |                      |
|   |  | Full range                         | 80         |             |                              |                      |
| $I_{DD}$ Supply current (four amplifiers)                             | $V_O = 2.5\text{ V},$<br>No load   | 25°C                               | 0.8        | 1           | $\text{mA}$                  |                      |
|   |  | Full range                         | 1          |             |                              |                      |

† Full range is 0°C to 70°C.

‡ Referenced to 2.5 V

NOTE 4. Typical values are based on the input offset voltage shift observed through 500 hours of operating life test at  $T_A = 150^\circ\text{C}$  extrapolated to  $T_A = 25^\circ\text{C}$  using the Arrhenius equation and assuming an activation energy of 0.96 eV.



**TLC226x, TLC226xA**  
**Advanced LinCMOS™ RAIL-TO-RAIL**  
**OPERATIONAL AMPLIFIERS**

SLOS177D – FEBRUARY 1997 – REVISED MARCH 2001

**TLC2264C operating characteristics at specified free-air temperature,  $V_{DD} = 5\text{ V}$**

| PARAMETER              |   | TEST CONDITIONS   |  | $T_A$ †    | TLC2264C   |        |                        | UNIT          |
|------------------------|---|---|--|------------|------------|--------|------------------------|---------------|
|                        |   |   |  |            | MIN        | TYP    | MAX                    |               |
| SR                     | Slew rate at unity gain                     | $V_O = 1.4\text{ V to }2.6\text{ V}, R_L = 50\text{ k}\Omega^\ddagger, C_L = 100\text{ pF}^\ddagger$                    |  | 25°C       | 0.35       | 0.55   | V/ $\mu\text{s}$       |               |
|                        |   |   |  | Full range | 0.3        |        |                        |               |
| $V_n$                  | Equivalent input noise voltage              |   |  | 25°C       | 40         |        | nV/ $\sqrt{\text{Hz}}$ |               |
|                        |   |   |  | 25°C       | 12         |        |                        |               |
| $V_{N(PP)}$            | Peak-to-peak equivalent input noise voltage |   |  | 25°C       | 0.7        |        | $\mu\text{V}$          |               |
|                        |   |   |  | 25°C       | 1.3        |        |                        |               |
| $I_n$                  | Equivalent input noise current              |   |  | 25°C       | 0.6        |        | fA/ $\sqrt{\text{Hz}}$ |               |
| THD + N                | Total harmonic distortion plus noise        | $V_O = 0.5\text{ V to }2.5\text{ V}, f = 20\text{ kHz}, R_L = 50\text{ k}\Omega^\ddagger$                               |  | 25°C       | $A_V = 1$  | 0.017% |                        |               |
|                        |   |   |  |            | $A_V = 10$ | 0.03%  |                        |               |
| Gain-bandwidth product |   | $f = 10\text{ kHz}, C_L = 100\text{ pF}^\ddagger$   |  | 25°C       | 0.71       |        | MHz                    |               |
| BOM                    | Maximum output-swing bandwidth              | $V_{O(PP)} = 2\text{ V}, R_L = 50\text{ k}\Omega^\ddagger,$   |  | 25°C       | 185        |        | kHz                    |               |
| $t_s$                  | Settling time                               | $A_V = -1, \text{ Step} = 0.5\text{ V to }2.5\text{ V}, R_L = 50\text{ k}\Omega^\ddagger, C_L = 100\text{ pF}^\ddagger$ |  | 25°C       | To 0.1%    | 6.4    |                        | $\mu\text{s}$ |
|                        |   |   |  |            | To 0.01%   | 14.1   |                        |               |
| $\phi_m$               | Phase margin at unity gain                  | $R_L = 50\text{ k}\Omega^\ddagger, C_L = 100\text{ pF}^\ddagger$  |  | 25°C       | 56°        |        |                        |               |
|                        | Gain margin                                 |   |  | 25°C       | 11         |        | dB                     |               |

† Full range is 0°C to 70°C.

‡ Referenced to 2.5 V

**TLC226x, TLC226xA**  
**Advanced LinCMOS™ RAIL-TO-RAIL**  
**OPERATIONAL AMPLIFIERS**

SLOS177D – FEBRUARY 1997 – REVISED MARCH 2001

**TLC2264C electrical characteristics at specified free-air temperature,  $V_{DD\pm} = \pm 5\text{ V}$  (unless otherwise specified)**

| PARAMETER  | TEST CONDITIONS  | T <sub>A</sub> †      | TLC2264C               |             |     | UNIT  |
|--|--|-----------------------|------------------------|-------------|-----|-------|
|  |  |                       | MIN                    | TYP         | MAX |       |
| V <sub>IO</sub> Input offset voltage   | V <sub>IC</sub> = 0, R <sub>S</sub> = 50 Ω, V <sub>O</sub> = 0,            | 25°C                  | 300                    | 2500        |     | μV    |
|  |  | Full range            |                        | 3000        |     |       |
| α <sub>VIO</sub> Temperature coefficient of input offset voltage                       |  | 25°C to 70°C          | 2                      |             |     | μV/°C |
| Input offset voltage long-term drift (see Note 4)                                      |  | 25°C                  | 0.003                  |             |     | μV/mo |
| I <sub>IO</sub> Input offset current   |  | 25°C                  | 0.5                    |             |     | pA    |
|  |  | Full range            |                        | 100         |     |       |
| I <sub>IB</sub> Input bias current   |  | 25°C                  | 1                      |             |     | pA    |
|  |  | Full range            |                        | 100         |     |       |
| V <sub>ICR</sub> Common-mode input voltage range                                       | V <sub>IO</sub>   ≤ 5 mV, R <sub>S</sub> = 50 Ω                            | 25°C                  | -5 to 4                | -5.3 to 4.2 |     | V     |
|  |  | Full range            | -5 to 3.5              |             |     |       |
| V <sub>OM+</sub> Maximum positive peak output voltage                                  | I <sub>O</sub> = -20 μA  | 25°C                  |                        | 4.99        |     | V     |
|  | I <sub>O</sub> = -100 μA   | 25°C                  | 4.85                   | 4.94        |     |       |
|  |  | Full range            | 4.82                   |             |     |       |
|  | I <sub>O</sub> = -400 μA   | 25°C                  | 4.7                    | 4.85        |     |       |
| Full range   |  | 4.6                   |                        |             |     |       |
| V <sub>OM-</sub> Maximum negative peak output voltage                                  | V <sub>IC</sub> = 0, I <sub>O</sub> = 50 μA                                | 25°C                  | -4.99                  |             | V   |       |
|  |  | 25°C                  | -4.85                  | -4.91       |     |       |
|  | V <sub>IC</sub> = 0, I <sub>O</sub> = 500 μA                               | Full range            | -4.85                  |             |     |       |
|  |  | 25°C                  | -4.7                   | -4.8        |     |       |
|  | V <sub>IC</sub> = 0, I <sub>O</sub> = 1 mA                                 | Full range            | -4.7                   |             |     |       |
|  |  | 25°C                  | -4                     | -4.3        |     |       |
| V <sub>IC</sub> = 0, I <sub>O</sub> = 4 mA   | Full range   | -3.8                  |                        |             |     |       |
|  | A <sub>VD</sub> Large-signal differential voltage amplification            | V <sub>O</sub> = ±4 V | R <sub>L</sub> = 50 kΩ | 25°C        | 80  | 200   |
| Full range   |  |                       |                        | 55          |     |       |
| R <sub>L</sub> = 1 MΩ  |  |                       | 25°C                   | 1000        |     |       |
| r <sub>i(d)</sub> Differential input resistance  |  | 25°C                  | 10 <sup>12</sup>       |             | Ω   |       |
| r <sub>i(c)</sub> Common-mode input resistance   |  | 25°C                  | 10 <sup>12</sup>       |             | Ω   |       |
| c <sub>i(c)</sub> Common-mode input capacitance  | f = 10 kHz, N package  | 25°C                  | 8                      |             | pF  |       |
| z <sub>o</sub> Closed-loop output impedance  | f = 100 kHz, A <sub>V</sub> = 10   | 25°C                  | 220                    |             | Ω   |       |
| CMRR Common-mode rejection ratio   | V <sub>IC</sub> = -5 V to 2.7 V, V <sub>O</sub> = 0, R <sub>S</sub> = 50 Ω | 25°C                  | 75                     | 88          | dB  |       |
|  |  | Full range            | 75                     |             |     |       |
| k <sub>SVR</sub> Supply-voltage rejection ratio (ΔV <sub>DD±</sub> /ΔV <sub>IO</sub> ) | V <sub>DD±</sub> = ±2.2 V to ±8 V, V <sub>IC</sub> = 0, No load            | 25°C                  | 80                     | 95          | dB  |       |
|  |  | Full range            | 80                     |             |     |       |
| I <sub>DD</sub> Supply current (four amplifiers)                                       | V <sub>O</sub> = 0, No load  | 25°C                  | 0.85                   | 1           | mA  |       |
|  |  | Full range            |                        | 1           |     |       |

† Full range is 0°C to 70°C.

NOTE 4: Typical values are based on the input offset voltage shift observed through 500 hours of operating life test at T<sub>A</sub> = 150°C extrapolated to T<sub>A</sub> = 25°C using the Arrhenius equation and assuming an activation energy of 0.96 eV.



**TLC2264C operating characteristics at specified free-air temperature,  $V_{DD\pm} = \pm 5\text{ V}$**

| PARAMETER   |   | TEST CONDITIONS  |                                      | $T_A$ †    | TLC2264C   |        |                        | UNIT          |
|-------------|---|--|--------------------------------------|------------|------------|--------|------------------------|---------------|
|             |   |  |                                      |            | MIN        | TYP    | MAX                    |               |
| SR          | Slew rate at unity gain                     | $V_O = \pm 1.9\text{ V}$ ,<br>$C_L = 100\text{ pF}$  | $R_L = 50\text{ k}\Omega$            | 25°C       | 0.35       | 0.55   | V/ $\mu\text{s}$       |               |
|             |   |  |                                      | Full range | 0.3        |        |                        |               |
| $V_n$       | Equivalent input noise voltage              |  |                                      | 25°C       | 43         |        | nV/ $\sqrt{\text{Hz}}$ |               |
|             |   |  |                                      | 25°C       | 12         |        |                        |               |
| $V_{N(PP)}$ | Peak-to-peak equivalent input noise voltage |  |                                      | 25°C       | 0.8        |        | $\mu\text{V}$          |               |
|             |   |  |                                      | 25°C       | 1.3        |        |                        |               |
| $I_n$       | Equivalent input noise current              |  |                                      | 25°C       | 0.6        |        | fA/ $\sqrt{\text{Hz}}$ |               |
| THD + N     | Total harmonic distortion plus noise        | $V_O = \pm 2.3\text{ V}$ ,<br>$f = 20\text{ kHz}$ ,<br>$R_L = 50\text{ k}\Omega$                                   |                                      | 25°C       | $A_V = 1$  | 0.014% |                        |               |
|             |   |  |                                      |            | $A_V = 10$ | 0.024% |                        |               |
|             | Gain-bandwidth product                      | $f = 10\text{ kHz}$ ,<br>$C_L = 100\text{ pF}$   | $R_L = 50\text{ k}\Omega$            | 25°C       | 0.73       |        | MHz                    |               |
| $B_{OM}$    | Maximum output-swing bandwidth              | $V_{O(PP)} = 4.6\text{ V}$ ,<br>$R_L = 50\text{ k}\Omega$  | $A_V = 1$ ,<br>$C_L = 100\text{ pF}$ | 25°C       | 70         |        | kHz                    |               |
| $t_s$       | Settling time                               | $A_V = -1$ ,<br>Step = $-2.3\text{ V}$ to $2.3\text{ V}$ ,<br>$R_L = 50\text{ k}\Omega$ ,<br>$C_L = 100\text{ pF}$ |                                      | 25°C       | To 0.1%    | 7.1    |                        | $\mu\text{s}$ |
|             |   |  |                                      |            | To 0.01%   | 16.5   |                        |               |
| $\phi_m$    | Phase margin at unity gain                  | $R_L = 50\text{ k}\Omega$  | $C_L = 100\text{ pF}$                | 25°C       | 57°        |        |                        |               |
|             | Gain margin                                 |  |                                      | 25°C       | 11         |        | dB                     |               |

† Full range is 0°C to 70°C.

# TLC226x, TLC226xA Advanced LinCMOS™ RAIL-TO-RAIL OPERATIONAL AMPLIFIERS

SLOS177D – FEBRUARY 1997 – REVISED MARCH 2001

**TLC2262I electrical characteristics at specified free-air temperature,  $V_{DD} = 5\text{ V}$  (unless otherwise noted)**

| PARAMETER  | TEST CONDITIONS  | $T_A$ †                      | TLC2262I   |             |      | TLC2262AI |             |          | UNIT                         |
|--|--|------------------------------|------------|-------------|------|-----------|-------------|----------|------------------------------|
|  |  |                              | MIN        | TYP         | MAX  | MIN       | TYP         | MAX      |                              |
| $V_{IO}$ Input offset voltage                                  | $V_{DD\pm} = \pm 2.5\text{ V}$ ,<br>$V_O = 0$ ,<br>$V_{IC} = 0$ ,<br>$R_S = 50\ \Omega$                          | 25°C                         | 300        | 2500        |      | 300       | 950         |          | $\mu\text{V}$                |
|  |  | Full range                   |            |             | 3000 |           | 1500        |          |                              |
| $\alpha_{VIO}$ Temperature coefficient of input offset voltage |  | 25°C to 85°C                 |            | 2           |      |           | 2           |          | $\mu\text{V}/^\circ\text{C}$ |
|  |  | 25°C                         |            | 0.003       |      |           | 0.003       |          | $\mu\text{V}/\text{mo}$      |
| $I_{IO}$ Input offset current                                  |  | 25°C                         |            | 0.5         |      |           | 0.5         |          | pA                           |
|  |  | 85°C                         |            |             | 150  |           | 150         |          | pA                           |
|  |  | Full range                   |            |             | 800  |           | 800         |          | pA                           |
| $I_{IB}$ Input bias current                                    |  | 25°C                         |            | 1           |      |           | 1           |          | pA                           |
|  | 85°C   |                              |            | 150         |      | 150       |             | pA       |                              |
|  | Full range   |                              |            | 800         |      | 800       |             | pA       |                              |
| $V_{ICR}$ Common-mode input voltage range                      | $R_S = 50\ \Omega$ ,<br>$ V_{IO}  \leq 5\text{ mV}$  | 25°C                         | 0 to 4     | -0.3 to 4.2 |      | 0 to 4    | -0.3 to 4.2 |          | V                            |
|  |  | Full range                   | 0 to 3.5   |             |      | 0 to 3.5  |             |          |                              |
| $V_{OH}$ High-level output voltage                             | $I_{OH} = -20\ \mu\text{A}$<br>$I_{OH} = -100\ \mu\text{A}$<br>$I_{OH} = -400\ \mu\text{A}$                      | 25°C                         |            | 4.99        |      |           | 4.99        |          | V                            |
|  |  | 25°C                         | 4.85       | 4.94        |      | 4.85      | 4.94        |          |                              |
|  |  | Full range                   | 4.82       |             |      | 4.82      |             |          |                              |
|  |  | 25°C                         | 4.7        | 4.85        |      | 4.7       | 4.85        |          |                              |
| $V_{OL}$ Low-level output voltage                              | $V_{IC} = 2.5\text{ V}$ ,<br>$I_{OL} = 50\ \mu\text{A}$<br>$I_{OL} = 500\ \mu\text{A}$<br>$I_{OL} = 4\text{ mA}$ | 25°C                         |            | 0.01        |      |           | 0.01        |          | V                            |
|  |  | 25°C                         | 0.09       | 0.15        |      | 0.09      | 0.15        |          |                              |
|  |  | Full range                   |            | 0.15        |      |           | 0.15        |          |                              |
|  |  | 25°C                         | 0.8        | 1           |      | 0.7       | 1           |          |                              |
| $A_{VD}$ Large-signal differential voltage amplification       | $V_{IC} = 2.5\text{ V}$ ,<br>$V_O = 1\text{ V to } 4\text{ V}$   | $R_L = 50\ \text{k}\Omega$ ‡ | 25°C       | 80          | 100  |           | 80          | 170      | V/mV                         |
|  |  |                              | Full range | 50          |      |           | 50          |          |                              |
|  |  | $R_L = 1\ \text{M}\Omega$ ‡  | 25°C       |             | 550  |           |             | 550      |                              |
| $r_{i(d)}$ Differential input resistance                       |  | 25°C                         |            | $10^{12}$   |      |           | $10^{12}$   | $\Omega$ |                              |
| $r_{i(c)}$ Common-mode input resistance                        |  | 25°C                         |            | $10^{12}$   |      |           | $10^{12}$   | $\Omega$ |                              |
| $C_{i(c)}$ Common-mode input capacitance                       | $f = 10\ \text{kHz}$ ,<br>P package  | 25°C                         |            | 8           |      |           | 8           | pF       |                              |
| $z_o$ Closed-loop output impedance                             | $f = 100\ \text{kHz}$ ,<br>$A_V = 10$  | 25°C                         |            | 240         |      |           | 240         | $\Omega$ |                              |
| CMRR Common-mode rejection ratio                               | $V_{IC} = 0\text{ to } 2.7\text{ V}$ ,<br>$V_O = 2.5\text{ V}$ ,<br>$R_S = 50\ \Omega$                           | 25°C                         | 70         | 83          |      | 70        | 83          | dB       |                              |
|  |  | Full range                   | 70         |             |      | 70        |             |          |                              |

† Full range is  $-40^\circ\text{C}$  to  $125^\circ\text{C}$ .

‡ Referenced to 2.5 V

NOTE 4: Typical values are based on the input offset voltage shift observed through 500 hours of operating life test at  $T_A = 150^\circ\text{C}$  extrapolated to  $T_A = 25^\circ\text{C}$  using the Arrhenius equation and assuming an activation energy of 0.96 eV.



**TLC2262I operating characteristics at specified free-air temperature,  $V_{DD} = 5\text{ V}$**

| PARAMETER   | TEST CONDITIONS  | $T_A$ †  | TLC2262I                                     |      |        | TLC2262AI |        |      | UNIT                         |               |
|-------------|--|--|--|------|--------|-----------|--------|------|------------------------------|---------------|
|             |  |  | MIN  | TYP  | MAX    | MIN       | TYP    | MAX  |                              |               |
| $k_{SVR}$   | Supply-voltage re-<br>jection ratio<br>( $\Delta V_{DD}/\Delta V_{IO}$ ) | $V_{DD} = 4.4\text{ V to }16\text{ V},$<br>$V_{IC} = V_{DD}/2,$<br>No load                                     | 25°C   | 80   | 95     |           | 80     | 95   | dB                           |               |
|             |  |  | Full range                                   | 80   |        |           | 80     |      |                              |               |
| $I_{DD}$    | Supply current   | $V_O = 2.5\text{ V},$<br>No load   | 25°C   |      | 400    | 500       |        | 400  | 500                          | $\mu\text{A}$ |
|             |  |  | Full range                                   |      |        | 500       |        |      | 500                          |               |
| SR          | Slew rate at unity gain  | $V_O = 1.5\text{ V to }3.5\text{ V},$<br>$R_L = 50\text{ k}\Omega^\ddagger,$<br>$C_L = 100\text{ pF}^\ddagger$ | 25°C   | 0.35 | 0.55   |           | 0.35   | 0.55 | $\text{V}/\mu\text{s}$       |               |
|             |  |  | Full range                                   | 0.25 |        |           | 0.25   |      |                              |               |
| $V_n$       | Equivalent input noise voltage   | $f = 10\text{ Hz}$<br>$f = 1\text{ kHz}$   | 25°C   |      | 40     |           |        | 40   | $\text{nV}/\sqrt{\text{Hz}}$ |               |
|             |  |  | 25°C   |      | 12     |           |        | 12   |                              |               |
| $V_{N(PP)}$ | Peak-to-peak equivalent input noise voltage                              | $f = 0.1\text{ Hz to }1\text{ Hz}$<br>$f = 0.1\text{ Hz to }10\text{ Hz}$                                      | 25°C   |      | 0.7    |           |        | 0.7  | $\mu\text{V}$                |               |
|             |  |  | 25°C   |      | 1.3    |           |        | 1.3  |                              |               |
| $I_n$       | Equivalent input noise current   |  | 25°C   |      | 0.6    |           |        | 0.6  | $\text{fA}/\sqrt{\text{Hz}}$ |               |
| THD + N     | Total harmonic distortion plus noise                                     | $V_O = 0.5\text{ V to }2.5\text{ V},$<br>$f = 20\text{ kHz},$<br>$R_L = 50\text{ k}\Omega^\ddagger$            | $A_V = 1$                                    | 25°C | 0.017% |           | 0.017% |      |                              |               |
|             |  |  | $A_V = 10$                                   |      | 0.03%  |           | 0.03%  |      |                              |               |
|             | Gain-bandwidth product   | $f = 50\text{ kHz},$<br>$C_L = 100\text{ pF}^\ddagger$   | $R_L = 50\text{ k}\Omega^\ddagger,$          | 25°C | 0.82   |           | 0.82   |      | MHz                          |               |
| $B_{OM}$    | Maximum output-swing bandwidth   | $V_{O(PP)} = 2\text{ V},$<br>$R_L = 50\text{ k}\Omega^\ddagger,$   | $A_V = 1,$<br>$C_L = 100\text{ pF}^\ddagger$ | 25°C | 185    |           | 185    |      | kHz                          |               |
| $t_s$       | Settling time  | $A_V = -1,$<br>Step = 0.5 V to 2.5 V,<br>$R_L = 50\text{ k}\Omega^\ddagger,$<br>$C_L = 100\text{ pF}^\ddagger$ | To 0.1%                                      | 25°C | 6.4    |           | 6.4    |      | $\mu\text{s}$                |               |
|             |  |  | To 0.01%                                     |      | 14.1   |           | 14.1   |      |                              |               |
| $\phi_m$    | Phase margin at unity gain   | $R_L = 50\text{ k}\Omega^\ddagger,$<br>$C_L = 100\text{ pF}^\ddagger$  | 25°C   | 56°  |        | 56°       |        |      |                              |               |
|             | Gain margin  |  | 25°C   | 11   |        | 11        |        |      | dB                           |               |

† Full range is  $-40^\circ\text{C}$  to  $125^\circ\text{C}$ .

‡ Referenced to 2.5 V

# TLC226x, TLC226xA Advanced LinCMOS™ RAIL-TO-RAIL OPERATIONAL AMPLIFIERS

SLOS177D – FEBRUARY 1997 – REVISED MARCH 2001

**TLC2262I electrical characteristics at specified free-air temperature,  $V_{DD\pm} = \pm 5\text{ V}$  (unless otherwise noted)**

| PARAMETER   | TEST CONDITIONS   | $T_A$ †                    | TLC2262I   |             |      | TLC2262AI |             |                              | UNIT |
|---|---|----------------------------|------------|-------------|------|-----------|-------------|------------------------------|------|
|   |   |                            | MIN        | TYP         | MAX  | MIN       | TYP         | MAX                          |      |
| $V_{IO}$ Input offset voltage   | $V_{IC} = 0, V_O = 0$<br>$R_S = 50\ \Omega$   | 25°C                       | 300        | 2500        |      | 300       | 950         | $\mu\text{V}$                |      |
|   |   | Full range                 |            |             | 3000 |           | 1500        |                              |      |
| $\alpha V_{IO}$ Temperature coefficient of input offset voltage                 |   | 25°C to 85°C               | 2          |             |      | 2         |             | $\mu\text{V}/^\circ\text{C}$ |      |
| Input offset voltage long-term drift (see Note 4)                               |   | 25°C                       | 0.003      |             |      | 0.003     |             | $\mu\text{V}/\text{mo}$      |      |
| $I_{IO}$ Input offset current   |   | 25°C                       | 0.5        |             |      | 0.5       |             | pA                           |      |
|   |   | 85°C                       |            |             | 150  |           | 150         | pA                           |      |
|   |   | Full range                 |            |             | 800  |           | 800         | pA                           |      |
| $I_{IB}$ Input bias current   |   | 25°C                       | 1          |             |      | 1         |             | pA                           |      |
|   | 85°C  |                            |            | 150         |      | 150       | pA          |                              |      |
|   | Full range  |                            |            | 800         |      | 800       | pA          |                              |      |
| $V_{ICR}$ Common-mode input voltage range                                       | $R_S = 50\ \Omega,  V_{IO}  \leq 5\ \text{mV}$  | 25°C                       | -5 to 4    | -5.3 to 4.2 |      | -5 to 4   | -5.3 to 4.2 | V                            |      |
|   |   | Full range                 | -5 to 3.5  |             |      | -5 to 3.5 |             |                              |      |
| $V_{OM+}$ Maximum positive peak output voltage                                  | $I_O = -20\ \mu\text{A}$<br>$I_O = -100\ \mu\text{A}$<br>$I_O = -400\ \mu\text{A}$                              | 25°C                       | 4.99       |             |      | 4.99      |             | V                            |      |
|   |   | 25°C                       | 4.85       | 4.94        |      | 4.85      | 4.94        |                              |      |
|   |   | Full range                 | 4.82       |             |      | 4.82      |             |                              |      |
|   |   | 25°C                       | 4.7        | 4.85        |      | 4.7       | 4.85        |                              |      |
| $V_{OM-}$ Maximum negative peak output voltage                                  | $V_{IC} = 0, I_O = 50\ \mu\text{A}$<br>$V_{IC} = 0, I_O = 500\ \mu\text{A}$<br>$V_{IC} = 0, I_O = 4\ \text{mA}$ | 25°C                       | -4.99      |             |      | -4.99     |             | V                            |      |
|   |   | 25°C                       | -4.85      | -4.91       |      | -4.85     | -4.91       |                              |      |
|   |   | Full range                 | -4.85      |             |      | -4.85     |             |                              |      |
|   |   | 25°C                       | -4         | -4.3        |      | -4        | -4.3        |                              |      |
| $A_{VD}$ Large-signal differential voltage amplification                        | $V_O = \pm 4\ \text{V}$   | $R_L = 50\ \text{k}\Omega$ | 25°C       | 80          | 200  |           | 80          | 200                          | V/mV |
|   |   |                            | Full range | 50          |      |           | 50          |                              |      |
|   |   | $R_L = 1\ \text{M}\Omega$  | 25°C       | 1000        |      |           | 1000        |                              |      |
| $r_{i(d)}$ Differential input resistance  |   | 25°C                       | 1012       |             |      | 1012      | $\Omega$    |                              |      |
| $r_{i(c)}$ Common-mode input resistance   |   | 25°C                       | 1012       |             |      | 1012      | $\Omega$    |                              |      |
| $C_{i(c)}$ Common-mode input capacitance  | $f = 10\ \text{kHz}, \text{ P package}$   | 25°C                       | 8          |             |      | 8         | pF          |                              |      |
| $z_o$ Closed-loop output impedance  | $f = 100\ \text{kHz}, A_V = 10$   | 25°C                       | 220        |             |      | 220       | $\Omega$    |                              |      |
| CMRR Common-mode rejection ratio  | $V_{IC} = -5\ \text{V to } 2.7\ \text{V}, V_O = 0, R_S = 50\ \Omega$  | 25°C                       | 75         | 88          |      | 75        | 88          | dB                           |      |
|   |   | Full range                 | 75         |             |      | 75        |             |                              |      |
| $k_{SVR}$ Supply-voltage rejection ratio ( $\Delta V_{DD\pm} / \Delta V_{IO}$ ) | $V_{DD} = 4.4\ \text{V to } 16\ \text{V}, V_{IC} = V_{DD}/2, \text{ No load}$                                   | 25°C                       | 80         | 95          |      | 80        | 95          | dB                           |      |
|   |   | Full range                 | 80         |             |      | 80        |             |                              |      |

† Full range is -40°C to 125°C.

NOTE 4: Typical values are based on the input offset voltage shift observed through 500 hours of operating life test at  $T_A = 150^\circ\text{C}$  extrapolated to  $T_A = 25^\circ\text{C}$  using the Arrhenius equation and assuming an activation energy of 0.96 eV.



**TLC2262I operating characteristics at specified free-air temperature,  $V_{DD\pm} = \pm 5\text{ V}$**

| PARAMETER   | TEST CONDITIONS  | $T_A$ †    | TLC2262I |            |     | TLC2262AI |      |                        | UNIT |
|---|--|------------|----------|------------|-----|-----------|------|------------------------|------|
|   |  |            | MIN      | TYP        | MAX | MIN       | TYP  | MAX                    |      |
| $I_{DD}$ Supply Current                                 | $V_O = 2.5\text{ V}$ ,<br>No load  | 25°C       | 425      | 500        |     | 425       | 500  |                        |      |
|   |  | Full range |          | 500        |     |           | 500  |                        |      |
| SR Slew rate at unity gain                              | $V_O = \pm 1.9\text{ V}$ ,<br>$C_L = 100\text{ pF}$ ,<br>$R_L = 50\text{ k}\Omega$                               | 25°C       | 0.35     | 0.55       |     | 0.35      | 0.55 | V/ $\mu\text{s}$       |      |
|   |  | Full range | 0.25     |            |     | 0.25      |      |                        |      |
| $V_n$ Equivalent input noise voltage                    | $f = 10\text{ Hz}$<br>$f = 1\text{ kHz}$   | 25°C       |          | 43         |     |           | 43   | nV/ $\sqrt{\text{Hz}}$ |      |
|   |  | 25°C       |          | 12         |     |           | 12   |                        |      |
| $V_{N(PP)}$ Peak-to-peak equivalent input noise voltage | $f = 0.1\text{ Hz to }1\text{ Hz}$<br>$f = 0.1\text{ Hz to }10\text{ Hz}$  | 25°C       |          | 0.8        |     |           | 0.8  | $\mu\text{V}$          |      |
|   |  | 25°C       |          | 1.3        |     |           | 1.3  |                        |      |
| $I_n$ Equivalent input noise current                    |  | 25°C       |          | 0.6        |     |           | 0.6  | fA/ $\sqrt{\text{Hz}}$ |      |
| THD + N Total harmonic distortion plus noise            | $V_O = \pm 2.3\text{ V}$ ,<br>$R_L = 50\text{ k}\Omega$ ,<br>$f = 20\text{ kHz}$                                 | 25°C       |          | $A_V = 1$  |     | 0.014%    |      | 0.014%                 |      |
|   |  |            |          | $A_V = 10$ |     | 0.024%    |      | 0.024%                 |      |
| Gain-bandwidth product                                  | $f = 10\text{ kHz}$ ,<br>$C_L = 100\text{ pF}$ ,<br>$R_L = 50\text{ k}\Omega$                                    | 25°C       |          | 0.73       |     |           | 0.73 | MHz                    |      |
| $B_{OM}$ Maximum output-swing bandwidth                 | $V_{O(PP)} = 4.6\text{ V}$ ,<br>$R_L = 50\text{ k}\Omega$ ,<br>$A_V = 1$ ,<br>$C_L = 100\text{ pF}$              | 25°C       |          | 85         |     |           | 85   | kHz                    |      |
| $t_s$ Settling time                                     | $A_V = -1$ ,<br>Step = $-2.3\text{ V to }2.3\text{ V}$ ,<br>$R_L = 50\text{ k}\Omega$ ,<br>$C_L = 100\text{ pF}$ | 25°C       |          | To 0.1%    |     | 7.1       |      | 7.1                    |      |
|   |  |            |          | To 0.01%   |     | 16.5      |      | 16.5                   |      |
| $\phi_m$ Phase margin at unity gain                     | $R_L = 50\text{ k}\Omega$ ,<br>$C_L = 100\text{ pF}$   | 25°C       |          | 57°        |     |           | 57°  |                        |      |
|   |  | 25°C       |          | 11         |     |           | 11   | dB                     |      |

† Full range is  $-40^\circ\text{C}$  to  $125^\circ\text{C}$ .

# TLC226x, TLC226xA Advanced LinCMOS™ RAIL-TO-RAIL OPERATIONAL AMPLIFIERS

SLOS177D – FEBRUARY 1997 – REVISED MARCH 2001

**TLC2264I electrical characteristics at specified free-air temperature,  $V_{DD} = 5\text{ V}$  (unless otherwise noted)**

| PARAMETER  | TEST CONDITIONS   | $T_A$ †                      | TLC2264I  |             |      | TLC2264AI |               |                              | UNIT          |
|--|---|------------------------------|-----------|-------------|------|-----------|---------------|------------------------------|---------------|
|  |   |                              | MIN       | TYP         | MAX  | MIN       | TYP           | MAX                          |               |
| $V_{IO}$ Input offset voltage  | $V_{DD} = \pm 2.5\text{ V}$ ,<br>$V_O = 0$ ,<br>$V_{IC} = 0$ ,<br>$R_S = 50\ \Omega$  | 25°C                         | 300       | 2500        |      | 300       | 950           | $\mu\text{V}$                |               |
|  |   | Full range                   |           |             | 3000 |           | 1500          |                              |               |
| $\alpha V_{IO}$ Temperature coefficient of input offset voltage            |   | 25°C to 125°C                | 2         |             |      | 2         |               | $\mu\text{V}/^\circ\text{C}$ |               |
| Input offset voltage long-term drift (see Note 4)                          |   | 25°C                         | 0.003     |             |      | 0.003     |               | $\mu\text{V}/\text{mo}$      |               |
| $I_{IO}$ Input offset current  |   | 25°C                         | 0.5       |             |      | 0.5       |               | $\text{pA}$                  |               |
|  |   | 85°C                         |           | 150         |      | 150       |               |                              |               |
|  |   | Full range                   |           | 800         |      | 800       |               |                              |               |
| $I_{IB}$ Input bias current  |   | 25°C                         | 1         |             |      | 1         |               | $\text{pA}$                  |               |
|  |   | 85°C                         |           | 150         |      | 150       |               |                              |               |
|  |   | Full range                   |           | 800         |      | 800       |               |                              |               |
| $V_{ICR}$ Common-mode input voltage range                                  | $R_S = 50\ \Omega$ ,<br>$ V_{IO}  \leq 5\text{ mV}$                                   | 25°C                         | 0 to 4    | -0.3 to 4.2 |      | 0 to 4    | -0.3 to 4.2   | $\text{V}$                   |               |
|  |   | Full range                   | 0 to 3.5  |             |      | 0 to 3.5  |               |                              |               |
| $V_{OH}$ High-level output voltage   | $I_{OH} = -20\ \mu\text{A}$   | 25°C                         | 4.99      |             |      | 4.99      |               | $\text{V}$                   |               |
|  | $I_{OH} = -100\ \mu\text{A}$  | 25°C                         | 4.85      | 4.94        |      | 4.85      | 4.94          |                              |               |
|  |   | Full range                   | 4.82      |             |      | 4.82      |               |                              |               |
|  | $I_{OH} = -400\ \mu\text{A}$  | 25°C                         | 4.7       | 4.85        |      | 4.7       | 4.85          |                              |               |
| Full range   |   | 4.5                          |           |             | 4.5  |           |               |                              |               |
| $V_{OL}$ Low-level output voltage  | $V_{IC} = 2.5\text{ V}$ ,<br>$I_{OL} = 50\ \mu\text{A}$                               | 25°C                         | 0.01      |             |      | 0.01      |               | $\text{V}$                   |               |
|  |   | Full range                   | 0.09      | 0.15        |      | 0.09      | 0.15          |                              |               |
|  | $V_{IC} = 2.5\text{ V}$ ,<br>$I_{OL} = 500\ \mu\text{A}$                              | 25°C                         | 0.09      | 0.15        |      | 0.09      | 0.15          |                              |               |
|  |   | Full range                   |           | 0.15        |      |           | 0.15          |                              |               |
| $V_{IC} = 2.5\text{ V}$ ,<br>$I_{OL} = 4\text{ mA}$                        | 25°C  | 0.8                          | 1         |             | 0.7  | 1         | $\text{V}$    |                              |               |
|  |   | Full range                   |           | 1.2         |      |           |               | 1.2                          |               |
|  | Full range  | 80                           | 100       |             | 80   | 170       |               | $\text{V/mV}$                |               |
|  |   | 50                           |           |             | 50   |           |               |                              |               |
| $A_{VD}$ Large-signal differential voltage amplification                   | $V_{IC} = 2.5\text{ V}$ ,<br>$V_O = 1\text{ V to }4\text{ V}$                         | $R_L = 50\ \text{k}\Omega$ ‡ | 25°C      | 80          | 100  |           | 80            | 170                          | $\text{V/mV}$ |
|  |   | Full range                   | 50        |             |      | 50        |               |                              |               |
| $R_L = 1\ \text{M}\Omega$ ‡  | 25°C  | 550                          |           |             | 550  |           | $\text{V/mV}$ |                              |               |
|  | Full range  |                              |           |             |      |           |               |                              |               |
| $r_{i(d)}$ Differential input resistance                                   |   | 25°C                         | $10^{12}$ |             |      | $10^{12}$ | $\Omega$      |                              |               |
| $r_{i(c)}$ Common-mode input resistance                                    |   | 25°C                         | $10^{12}$ |             |      | $10^{12}$ | $\Omega$      |                              |               |
| $C_{i(c)}$ Common-mode input capacitance                                   | $f = 10\text{ kHz}$ ,<br>N package  | 25°C                         | 8         |             |      | 8         | $\text{pF}$   |                              |               |
| $z_o$ Closed-loop output impedance   | $f = 100\text{ kHz}$ ,<br>$A_V = 10$  | 25°C                         | 240       |             |      | 240       | $\Omega$      |                              |               |
| CMRR Common-mode rejection ratio   | $V_{IC} = 0\text{ to }2.7\text{ V}$ ,<br>$V_O = 2.5\text{ V}$ ,<br>$R_S = 50\ \Omega$ | 25°C                         | 70        | 83          |      | 70        | 83            | $\text{dB}$                  |               |
|  |   | Full range                   | 70        |             |      | 70        |               |                              |               |
| $k_{SVR}$ Supply-voltage rejection ratio ( $\Delta V_{DD}/\Delta V_{IO}$ ) | $V_{DD} = 4.4\text{ V to }16\text{ V}$ ,<br>$V_{IC} = V_{DD}/2$ ,<br>No load          | 25°C                         | 80        | 95          |      | 80        | 95            | $\text{dB}$                  |               |
|  |   | Full range                   | 80        |             |      | 80        |               |                              |               |

† Full range is  $-40^\circ\text{C}$  to  $125^\circ\text{C}$ .

‡ Referenced to 2.5 V

NOTE 4: Typical values are based on the input offset voltage shift observed through 500 hours of operating life test at  $T_A = 150^\circ\text{C}$  extrapolated to  $T_A = 25^\circ\text{C}$  using the Arrhenius equation and assuming an activation energy of 0.96 eV.



**TLC2264I operating characteristics at specified free-air temperature,  $V_{DD} = 5\text{ V}$**

| PARAMETER   | TEST CONDITIONS   | $T_A$ †    | TLC2264I |            |     | TLC2264AI |      |                       | UNIT          |
|-------------|---|------------|----------|------------|-----|-----------|------|-----------------------|---------------|
|             |   |            | MIN      | TYP        | MAX | MIN       | TYP  | MAX                   |               |
| $I_{DD}$    | Supply current<br>(four amplifiers)<br>$V_O = 2.5\text{ V}$ , No load   | 25°C       | 0.8      | 1          |     | 0.8       | 1    | $V/\mu\text{s}$       |               |
|             |   | Full range |          |            | 1   |           | 1    |                       |               |
| SR          | Slew rate at unity gain<br>$V_O = 1.4\text{ V to }2.6\text{ V}$ ,<br>$R_L = 50\text{ k}\Omega^\ddagger$ ,<br>$C_L = 100\text{ pF}^\ddagger$   | 25°C       | 0.35     | 0.55       |     | 0.35      | 0.55 | $V/\mu\text{s}$       |               |
|             |   | Full range | 0.25     |            |     | 0.25      |      |                       |               |
| $V_n$       | Equivalent input noise voltage<br>$f = 10\text{ Hz}$<br>$f = 1\text{ kHz}$  | 25°C       |          | 40         |     |           | 40   | $nV/\sqrt{\text{Hz}}$ |               |
|             |   | 25°C       |          | 12         |     |           | 12   |                       |               |
| $V_{N(PP)}$ | Peak-to-peak equivalent input noise voltage<br>$f = 0.1\text{ Hz to }1\text{ Hz}$<br>$f = 0.1\text{ Hz to }10\text{ Hz}$                      | 25°C       |          | 0.7        |     |           | 0.7  | $\mu\text{V}$         |               |
|             |   | 25°C       |          | 1.3        |     |           | 1.3  |                       |               |
| $I_n$       | Equivalent input noise current  | 25°C       |          | 0.6        |     |           | 0.6  | $fA/\sqrt{\text{Hz}}$ |               |
| THD + N     | Total harmonic distortion plus noise<br>$V_O = 0.5\text{ V to }2.5\text{ V}$ ,<br>$f = 20\text{ kHz}$ ,<br>$R_L = 50\text{ k}\Omega^\ddagger$ | 25°C       |          | $A_V = 1$  |     | 0.017%    |      | 0.017%                |               |
|             |   |            |          | $A_V = 10$ |     | 0.03%     |      | 0.03%                 |               |
|             | Gain-bandwidth product<br>$f = 50\text{ kHz}$ ,<br>$C_L = 100\text{ pF}^\ddagger$   | 25°C       |          | 0.71       |     |           | 0.71 | MHz                   |               |
| $B_{OM}$    | Maximum output-swing bandwidth<br>$V_{O(PP)} = 2\text{ V}$ ,<br>$R_L = 50\text{ k}\Omega^\ddagger$  | 25°C       |          | 185        |     |           | 185  | kHz                   |               |
| $t_s$       | Settling time<br>$A_V = -1$ ,<br>Step = 0.5 V to 2.5 V,<br>$R_L = 50\text{ k}\Omega^\ddagger$ ,<br>$C_L = 100\text{ pF}^\ddagger$             | 25°C       |          | To 0.1%    |     | 6.4       |      | 6.4                   | $\mu\text{s}$ |
|             |   |            |          | To 0.01%   |     | 14.1      |      | 14.1                  |               |
| $\phi_m$    | Phase margin at unity gain<br>$R_L = 50\text{ k}\Omega^\ddagger$ ,<br>$C_L = 100\text{ pF}^\ddagger$  | 25°C       |          | 56°        |     |           | 56°  |                       |               |
|             |   | 25°C       |          | 11         |     |           | 11   |                       |               |
|             | Gain margin   | 25°C       |          | 11         |     |           | 11   | dB                    |               |

† Full range is – 40°C to 125°C.

‡ Referenced to 2.5 V

# TLC226x, TLC226xA Advanced LinCMOS™ RAIL-TO-RAIL OPERATIONAL AMPLIFIERS

SLOS177D – FEBRUARY 1997 – REVISED MARCH 2001

**TLC2264I electrical characteristics at specified free-air temperature,  $V_{DD\pm} = \pm 5\text{ V}$  (unless otherwise noted)**

| PARAMETER   | TEST CONDITIONS  | $T_A$ †                    | TLC2264I   |             |      | TLC2264AI |             |                              | UNIT |
|---|--|----------------------------|------------|-------------|------|-----------|-------------|------------------------------|------|
|   |  |                            | MIN        | TYP         | MAX  | MIN       | TYP         | MAX                          |      |
| $V_{IO}$ Input offset voltage   |  | 25°C                       | 300        | 2500        |      | 300       | 950         | $\mu\text{V}$                |      |
|   |  | Full range                 |            |             | 3000 |           | 1500        |                              |      |
| $\alpha V_{IO}$ Temperature coefficient of input offset voltage               |  | 25°C to 125°C              | 2          |             |      | 2         |             | $\mu\text{V}/^\circ\text{C}$ |      |
| Input offset voltage long-term drift (see Note 4)                             | $V_{IC} = 0, V_O = 0, R_S = 50\ \Omega$  | 25°C                       | 0.003      |             |      | 0.003     |             | $\mu\text{V}/\text{mo}$      |      |
| $I_{IO}$ Input offset current   |  | 25°C                       | 0.5        |             |      | 0.5       |             | pA                           |      |
|   | 85°C   |                            | 150        |             | 150  |           |             |                              |      |
|   | Full range   |                            | 800        |             | 800  |           |             |                              |      |
| $I_{IB}$ Input bias current   |  | 25°C                       | 1          |             |      | 1         |             | pA                           |      |
|   |  | 85°C                       |            | 150         |      | 150       |             | pA                           |      |
|   |  | Full range                 |            | 800         |      | 800       |             | pA                           |      |
| $V_{ICR}$ Common-mode input voltage range                                     | $R_S = 50\ \Omega,  V_{IO}  \leq 5\ \text{mV}$   | 25°C                       | -5 to 4    | -5.3 to 4.2 |      | -5 to 4   | -5.3 to 4.2 | V                            |      |
|   |  | Full range                 | -5 to 3.5  |             |      | -5 to 3.5 |             |                              |      |
| $V_{OM+}$ Maximum positive peak output voltage                                | $I_O = -20\ \mu\text{A}$   | 25°C                       | 4.99       |             |      | 4.99      |             | V                            |      |
|   | $I_O = -100\ \mu\text{A}$  | 25°C                       | 4.85       | 4.94        |      | 4.85      | 4.94        |                              |      |
|   |  | Full range                 | 4.82       |             |      | 4.82      |             |                              |      |
|   | $I_O = -400\ \mu\text{A}$  | 25°C                       | 4.7        | 4.85        |      | 4.7       | 4.85        |                              |      |
| $V_{OM-}$ Maximum negative peak output voltage                                | $V_{IC} = 0, I_O = 50\ \mu\text{A}$  | 25°C                       | -4.99      |             |      | -4.99     |             | V                            |      |
|   |  | 25°C                       | -4.85      | -4.91       |      | -4.85     | -4.91       |                              |      |
|   | $V_{IC} = 0, I_O = 500\ \mu\text{A}$   | Full range                 | -4.85      |             |      | -4.85     |             |                              |      |
|   |  | 25°C                       | -4         | -4.3        |      | -4        | -4.3        |                              |      |
| $V_{IC} = 0, I_O = 4\ \text{mA}$  | Full range   | -3.8                       |            |             | -3.8 |           |             |                              |      |
|   |  |                            |            |             |      |           |             |                              |      |
| $A_{VD}$ Large-signal differential voltage amplification                      | $V_O = \pm 4\ \text{V}$  | $R_L = 50\ \text{k}\Omega$ | 25°C       | 80          | 200  |           | 80          | 200                          | V/mV |
|   |  |                            | Full range | 50          |      |           | 50          |                              |      |
|   |  | $R_L = 1\ \text{M}\Omega$  | 25°C       | 1000        |      |           | 1000        |                              |      |
| $r_{i(d)}$ Differential input resistance                                      |  | 25°C                       | $10^{12}$  |             |      | $10^{12}$ |             | $\Omega$                     |      |
| $r_{i(c)}$ Common-mode input resistance                                       |  | 25°C                       | $10^{12}$  |             |      | $10^{12}$ |             | $\Omega$                     |      |
| $C_{i(c)}$ Common-mode input capacitance                                      | $f = 10\ \text{kHz}, \text{N package}$   | 25°C                       | 8          |             |      | 8         |             | pF                           |      |
| $z_o$ Closed-loop output impedance  | $f = 100\ \text{kHz}, A_V = 10$  | 25°C                       | 220        |             |      | 220       |             | $\Omega$                     |      |
| CMRR Common-mode rejection ratio  | $V_{IC} = -5\ \text{V to } 2.7\ \text{V}, V_O = 0, R_S = 50\ \Omega$                   | 25°C                       | 75         | 88          |      | 75        | 88          | dB                           |      |
|   |  | Full range                 | 75         |             |      | 75        |             |                              |      |
| $k_{SVR}$ Supply-voltage rejection ratio ( $\Delta V_{DD\pm}/\Delta V_{IO}$ ) | $V_{DD\pm} = \pm 2.2\ \text{V to } \pm 8\ \text{V}, V_{IC} = V_{DD}/2, \text{No load}$ | 25°C                       | 80         | 95          |      | 80        | 95          | dB                           |      |
|   |  | Full range                 | 80         |             |      | 80        |             |                              |      |

† Full range is -40°C to 125°C.

NOTE 4: Typical values are based on the input offset voltage shift observed through 500 hours of operating life test at  $T_A = 150^\circ\text{C}$  extrapolated to  $T_A = 25^\circ\text{C}$  using the Arrhenius equation and assuming an activation energy of 0.96 eV.



**TLC2264I operating characteristics at specified free-air temperature,  $V_{DD\pm} = \pm 5\text{ V}$**

| PARAMETER   | TEST CONDITIONS   | $T_A$ †     | TLC2264I |      |     | TLC2264AI |      |                | UNIT |
|---|---|-------------|----------|------|-----|-----------|------|----------------|------|
|   |   |             | MIN      | TYP  | MAX | MIN       | TYP  | MAX            |      |
| $I_{DD}$ Supply current (four amplifiers)               | $V_O = 0$ , No load   | 25°C        | 0.85     | 1    |     | 0.85      | 1    |                |      |
|   |   | Full range  |          |      | 1   |           | 1    |                |      |
| SR Slew rate at unity gain                              | $V_O = \pm 1.9\text{ V}$ , $C_L = 100\text{ pF}$ , $R_L = 50\text{ k}\Omega$                            | 25°C        | 0.35     | 0.55 |     | 0.35      | 0.55 |                |      |
|   |   | Full range  | 0.25     |      |     | 0.25      |      |                |      |
| $V_n$ Equivalent input noise voltage                    | $f = 10\text{ Hz}$  | 25°C        |          | 43   |     |           | 43   | $nV/\sqrt{Hz}$ |      |
|   | $f = 1\text{ kHz}$  | 25°C        |          | 12   |     |           | 12   |                |      |
| $V_{N(PP)}$ Peak-to-peak equivalent input noise voltage | $f = 0.1\text{ Hz to }1\text{ Hz}$  | 25°C        |          | 0.8  |     |           | 0.8  | $\mu V$        |      |
|   | $f = 0.1\text{ Hz to }10\text{ Hz}$   | 25°C        |          | 1.3  |     |           | 1.3  |                |      |
| $I_n$ Equivalent input noise current                    |   | 25°C        |          | 0.6  |     |           | 0.6  | $fA/\sqrt{Hz}$ |      |
| THD + N Total harmonic distortion plus noise            | $V_O = \pm 2.3\text{ V}$ , $R_L = 50\text{ k}\Omega$ , $f = 20\text{ kHz}$                              | $A_V = 1$   | 25°C     |      |     | 0.014%    |      | 0.014%         |      |
|   |   | $A_V = 10$  | 25°C     |      |     | 0.024%    |      | 0.024%         |      |
| Gain-bandwidth product                                  | $f = 10\text{ kHz}$ , $C_L = 100\text{ pF}$ , $R_L = 50\text{ k}\Omega$                                 | 25°C        |          | 0.73 |     |           | 0.73 | MHz            |      |
| $B_{OM}$ Maximum output-swing bandwidth                 | $V_{O(PP)} = 4.6\text{ V}$ , $R_L = 50\text{ k}\Omega$ , $A_V = 1$ , $C_L = 100\text{ pF}$              | 25°C        |          | 70   |     |           | 70   | kHz            |      |
| $t_s$ Settling time                                     | $A_V = -1$ , Step = $-2.3\text{ V to }2.3\text{ V}$ , $R_L = 50\text{ k}\Omega$ , $C_L = 100\text{ pF}$ | To 0.1%     | 25°C     |      |     | 7.1       |      | 7.1            |      |
|   |   | To 0.01%    | 25°C     |      |     | 16.5      |      | 16.5           |      |
| $\phi_m$ Phase margin at unity gain                     | $R_L = 50\text{ k}\Omega$ , $C_L = 100\text{ pF}$   | 25°C        |          | 57°  |     |           | 57°  |                |      |
|   |   | Gain margin | 25°C     |      | 11  |           |      | 11             | dB   |

† Full range is  $-40^\circ\text{C}$  to  $125^\circ\text{C}$ .

# TLC226x, TLC226xA Advanced LinCMOS™ RAIL-TO-RAIL OPERATIONAL AMPLIFIERS

SLOS177D – FEBRUARY 1997 – REVISED MARCH 2001

**TLC2262Q/M electrical characteristics at specified free-air temperature,  $V_{DD} = 5\text{ V}$  (unless otherwise noted)**

| PARAMETER  | TEST CONDITIONS   | $T_A$ †                     | TLC2262Q,<br>TLC2262M |             |      | TLC2262AQ,<br>TLC2262AM |             |                              | UNIT          |
|--|---|-----------------------------|-----------------------|-------------|------|-------------------------|-------------|------------------------------|---------------|
|  |   |                             | MIN                   | TYP         | MAX  | MIN                     | TYP         | MAX                          |               |
| $V_{IO}$ Input offset voltage  | $V_{DD\pm} = \pm 2.5\text{ V}$ ,<br>$V_O = 0$ ,<br>$V_{IC} = 0$ ,<br>$R_S = 50\ \Omega$ | 25°C                        | 300                   | 2500        |      | 300                     | 950         | $\mu\text{V}$                |               |
|  |   | Full range                  |                       |             | 3000 |                         | 1500        |                              |               |
| $\alpha_{VIO}$ Temperature coefficient of input offset voltage             |   | Full range                  |                       | 5           |      |                         | 5           | $\mu\text{V}/^\circ\text{C}$ |               |
| Input offset voltage long-term drift (see Note 4)                          |   | 25°C                        |                       | 0.003       |      |                         | 0.003       | $\mu\text{V}/\text{mo}$      |               |
| $I_{IO}$ Input offset current  |   | 25°C                        |                       | 0.5         |      |                         | 0.5         | $\text{pA}$                  |               |
|  |   | 125°C                       |                       |             | 800  |                         | 800         |                              |               |
| $I_{IB}$ Input bias current  | 25°C  |                             | 1                     |             |      | 1                       | $\text{pA}$ |                              |               |
|  | 125°C   |                             |                       | 800         |      | 800                     |             |                              |               |
| $V_{ICR}$ Common-mode input voltage range                                  | $R_S = 50\ \Omega$ ,<br>$ V_{IO}  \leq 5\text{ mV}$                                     | 25°C                        | 0 to 4                | -0.3 to 4.2 |      | 0 to 4                  | -0.3 to 4.2 | V                            |               |
|  |   | Full range                  | 0 to 3.5              |             |      | 0 to 3.5                |             |                              |               |
| $V_{OH}$ High-level output voltage   | $I_{OH} = -20\ \mu\text{A}$   | 25°C                        |                       | 4.99        |      |                         | 4.99        | V                            |               |
|  |   | 25°C                        | 4.85                  | 4.94        |      | 4.85                    | 4.94        |                              |               |
|  |   | Full range                  | 4.82                  |             |      | 4.82                    |             |                              |               |
|  |   | 25°C                        | 4.7                   | 4.85        |      | 4.7                     | 4.85        |                              |               |
| $V_{OL}$ Low-level output voltage  | $V_{IC} = 2.5\text{ V}$ ,<br>$I_{OL} = 50\ \mu\text{A}$                                 | 25°C                        |                       | 0.01        |      |                         | 0.01        | V                            |               |
|  |   | 25°C                        | 0.09                  | 0.15        |      | 0.09                    | 0.15        |                              |               |
|  |   | Full range                  |                       | 0.15        |      |                         | 0.15        |                              |               |
|  |   | 25°C                        | 0.8                   | 1           |      | 0.7                     | 1           |                              |               |
| $V_{OL}$ Low-level output voltage  | $V_{IC} = 2.5\text{ V}$ ,<br>$I_{OL} = 500\ \mu\text{A}$                                | 25°C                        |                       | 0.01        |      |                         | 0.01        | V                            |               |
|  |   | 25°C                        | 0.09                  | 0.15        |      | 0.09                    | 0.15        |                              |               |
|  |   | Full range                  |                       | 0.15        |      |                         | 0.15        |                              |               |
|  |   | 25°C                        | 0.8                   | 1           |      | 0.7                     | 1           |                              |               |
| $V_{OL}$ Low-level output voltage  | $V_{IC} = 2.5\text{ V}$ ,<br>$I_{OL} = 4\text{ mA}$                                     | 25°C                        |                       | 0.01        |      |                         | 0.01        | V                            |               |
|  |   | 25°C                        | 0.09                  | 0.15        |      | 0.09                    | 0.15        |                              |               |
|  |   | Full range                  |                       | 0.15        |      |                         | 0.15        |                              |               |
|  |   | 25°C                        | 0.8                   | 1           |      | 0.7                     | 1           |                              |               |
| $A_{VD}$ Large-signal differential voltage amplification                   | $V_{IC} = 2.5\text{ V}$ ,<br>$V_O = 1\text{ V to }4\text{ V}$                           | $R_L = 50\text{ k}\Omega$ ‡ | 25°C                  | 80          | 100  |                         | 80          | 170                          | V/mV          |
|  |   |                             | Full range            | 50          |      |                         | 50          |                              |               |
|  |   | $R_L = 1\text{ M}\Omega$ ‡  | 25°C                  |             | 550  |                         |             | 550                          |               |
| $r_{i(d)}$ Differential input resistance                                   |   | 25°C                        |                       | $10^{12}$   |      |                         | $10^{12}$   | $\Omega$                     |               |
| $r_{i(c)}$ Common-mode input resistance                                    |   | 25°C                        |                       | $10^{12}$   |      |                         | $10^{12}$   | $\Omega$                     |               |
| $C_{i(c)}$ Common-mode input capacitance                                   | $f = 10\text{ kHz}$ ,<br>P package  | 25°C                        |                       | 8           |      |                         | 8           | pF                           |               |
| $Z_o$ Closed-loop output impedance   | $f = 100\text{ kHz}$ ,<br>$A_V = 10$  | 25°C                        |                       | 240         |      |                         | 240         | $\Omega$                     |               |
| CMRR Common-mode rejection ratio   | $V_{IC} = 0\text{ to }2.7\text{ V}$ ,<br>$V_O = 2.5\text{ V}$ ,<br>$R_S = 50\ \Omega$   | 25°C                        | 70                    | 83          |      | 70                      | 83          | dB                           |               |
|  |   | Full range                  | 70                    |             |      | 70                      |             |                              |               |
| $k_{SVR}$ Supply-voltage rejection ratio ( $\Delta V_{DD}/\Delta V_{IO}$ ) | $V_{DD} = 4.4\text{ V to }16\text{ V}$ ,<br>$V_{IC} = V_{DD}/2$ ,<br>No load            | 25°C                        | 80                    | 95          |      | 80                      | 95          | dB                           |               |
|  |   | Full range                  | 80                    |             |      | 80                      |             |                              |               |
| $I_{DD}$ Supply current  | $V_O = 2.5\text{ V}$ ,<br>No load   | 25°C                        |                       | 400         | 500  |                         | 400         | 500                          | $\mu\text{A}$ |
|  |   | Full range                  |                       |             | 500  |                         |             | 500                          |               |

† Full range is  $-40^\circ\text{C}$  to  $125^\circ\text{C}$  for Q suffix,  $-55^\circ\text{C}$  to  $125^\circ\text{C}$  for M suffix.

‡ Referenced to 2.5 V

NOTE 4: Typical values are based on the input offset voltage shift observed through 500 hours of operating life test at  $T_A = 150^\circ\text{C}$  extrapolated to  $T_A = 25^\circ\text{C}$  using the Arrhenius equation and assuming an activation energy of 0.96 eV.



**TLC2262Q/M operating characteristics at specified free-air temperature,  $V_{DD} = 5\text{ V}$**

| PARAMETER   | TEST CONDITIONS  | $T_A$ †    | TLC2262Q,<br>TLC2262M |      |     | TLC2262AQ,<br>TLC2262AM |      |     | UNIT                   |
|-------------|--|------------|-----------------------|------|-----|-------------------------|------|-----|------------------------|
|             |  |            | MIN                   | TYP  | MAX | MIN                     | TYP  | MAX |                        |
| SR          | Slew rate at unity gain<br>$V_O = 0.5\text{ V to }3.5\text{ V}, R_L = 50\text{ k}\Omega\ddagger, C_L = 100\text{ pF}\ddagger$          | 25°C       | 0.35                  | 0.55 |     | 0.35                    | 0.55 |     | V/ $\mu$ s             |
|             |  | Full range | 0.25                  |      |     | 0.25                    |      |     |                        |
| $V_n$       | Equivalent input noise voltage<br>$f = 10\text{ Hz}$<br>$f = 1\text{ kHz}$   | 25°C       | 40                    |      |     | 40                      |      |     | nV/ $\sqrt{\text{Hz}}$ |
|             |  | 25°C       | 12                    |      |     | 12                      |      |     |                        |
| $V_{N(PP)}$ | Peak-to-peak equivalent input noise voltage<br>$f = 0.1\text{ Hz to }1\text{ Hz}$<br>$f = 0.1\text{ Hz to }10\text{ Hz}$               | 25°C       | 0.7                   |      |     | 0.7                     |      |     | $\mu$ V                |
|             |  | 25°C       | 1.3                   |      |     | 1.3                     |      |     |                        |
| $I_n$       | Equivalent input noise current   | 25°C       | 0.6                   |      |     | 0.6                     |      |     | fA/ $\sqrt{\text{Hz}}$ |
| THD + N     | Total harmonic distortion plus noise<br>$V_O = 0.5\text{ V to }2.5\text{ V}, f = 20\text{ kHz}, R_L = 50\text{ k}\Omega\ddagger$       | 25°C       | $A_V = 1$             |      |     | 0.017%                  |      |     |                        |
|             |  |            | $A_V = 10$            |      |     | 0.03%                   |      |     |                        |
|             | Gain-bandwidth product<br>$f = 50\text{ kHz}, C_L = 100\text{ pF}\ddagger$   | 25°C       | 0.82                  |      |     | 0.82                    |      |     | MHz                    |
| $B_{OM}$    | Maximum output-swing bandwidth<br>$V_{O(PP)} = 2\text{ V}, R_L = 50\text{ k}\Omega\ddagger, C_L = 100\text{ pF}\ddagger$               | 25°C       | 185                   |      |     | 185                     |      |     | kHz                    |
| $t_s$       | Settling time<br>$A_V = -1, \text{ Step} = 0.5\text{ V to }2.5\text{ V}, R_L = 50\text{ k}\Omega\ddagger, C_L = 100\text{ pF}\ddagger$ | 25°C       | To 0.1%               |      |     | 6.4                     |      |     | $\mu$ s                |
|             |  |            | To 0.01%              |      |     | 14.1                    |      |     |                        |
| $\phi_m$    | Phase margin at unity gain<br>$R_L = 50\text{ k}\Omega\ddagger, C_L = 100\text{ pF}\ddagger$   | 25°C       | 56°                   |      |     | 56°                     |      |     |                        |
|             |  | 25°C       | 11                    |      |     | 11                      |      |     | dB                     |

† Full range is  $-40^\circ\text{C}$  to  $125^\circ\text{C}$  for Q suffix,  $-55^\circ\text{C}$  to  $125^\circ\text{C}$  for M suffix.

‡ Referenced to 2.5 V

# TLC226x, TLC226xA Advanced LinCMOS™ RAIL-TO-RAIL OPERATIONAL AMPLIFIERS

SLOS177D – FEBRUARY 1997 – REVISED MARCH 2001

**TLC2262Q/M electrical characteristics at specified free-air temperature,  $V_{DD\pm} = \pm 5\text{ V}$  (unless otherwise noted)**

| PARAMETER   | TEST CONDITIONS  | $T_A$ †                    | TLC2262Q,<br>TLC2262M |           |     | TLC2262AQ,<br>TLC2262AM |             |                              | UNIT |
|---|--|----------------------------|-----------------------|-----------|-----|-------------------------|-------------|------------------------------|------|
|   |  |                            | MIN                   | TYP       | MAX | MIN                     | TYP         | MAX                          |      |
| $V_{IO}$ Input offset voltage   | $V_{IC} = 0, \quad V_O = 0,$<br>$R_S = 50\ \Omega$                                 | 25°C                       | 300                   | 2500      |     | 300                     | 950         | $\mu\text{V}$                |      |
|   |  | Full range                 |                       | 3000      |     | 1500                    |             |                              |      |
| $\alpha_{VIO}$ Temperature coefficient of input offset voltage                  |  | Full range                 | 5                     |           |     | 5                       |             | $\mu\text{V}/^\circ\text{C}$ |      |
| Input offset voltage long-term drift (see Note 4)                               |  | 25°C                       | 0.003                 |           |     | 0.003                   |             | $\mu\text{V}/\text{mo}$      |      |
| $I_{IO}$ Input offset current   |  | 25°C                       | 0.5                   |           |     | 0.5                     |             | $\text{pA}$                  |      |
|   |  | 125°C                      |                       | 800       |     | 800                     |             |                              |      |
| $I_{IB}$ Input bias current   | 25°C   | 1                          |                       |           | 1   |                         | $\text{pA}$ |                              |      |
|   | 125°C  |                            | 800                   |           | 800 |                         |             |                              |      |
| $V_{ICR}$ Common-mode input voltage range                                       | $R_S = 50\ \Omega, \quad  V_{IO}  \leq 5\ \text{mV}$                               | 25°C                       | -5 to 4               | -5.3 to 4 |     | -5 to 4                 | -5.3 to 4.2 | V                            |      |
|   |  | Full range                 | -5 to 3.5             |           |     | -5 to 3.5               |             |                              |      |
| $V_{OM+}$ Maximum positive peak output voltage                                  | $I_O = -20\ \mu\text{A}$   | 25°C                       | 4.99                  |           |     | 4.99                    | V           |                              |      |
|   |  | 25°C                       | 4.85                  | 4.94      |     | 4.85                    |             | 4.94                         |      |
|   |  | Full range                 | 4.82                  |           |     | 4.82                    |             |                              |      |
|   |  | 25°C                       | 4.7                   | 4.85      |     | 4.7                     |             | 4.85                         |      |
| $V_{OM-}$ Maximum negative peak output voltage                                  | $I_O = -400\ \mu\text{A}$  | 25°C                       | -4.99                 |           |     | -4.99                   | V           |                              |      |
|   |  | 25°C                       | -4.85                 | -4.91     |     | -4.85                   |             | -4.91                        |      |
|   |  | Full range                 | -4.85                 |           |     | -4.85                   |             |                              |      |
|   |  | 25°C                       | -4                    | -4.3      |     | -4                      |             | -4.3                         |      |
| $A_{VD}$ Large-signal differential voltage amplification                        | $V_O = \pm 4\ \text{V}$  | $R_L = 50\ \text{k}\Omega$ | 25°C                  | 80        | 200 |                         | 80          | 200                          | V/mV |
|   |  |                            | Full range            | 50        |     |                         | 50          |                              |      |
|   |  | $R_L = 1\ \text{M}\Omega$  | 25°C                  | 1000      |     |                         | 1000        |                              |      |
|   |  |                            | Full range            |           |     |                         |             |                              |      |
| $r_{i(d)}$ Differential input resistance  |  | 25°C                       | 10 <sup>12</sup>      |           |     | 10 <sup>12</sup>        | $\Omega$    |                              |      |
| $r_{i(c)}$ Common-mode input resistance   |  | 25°C                       | 10 <sup>12</sup>      |           |     | 10 <sup>12</sup>        | $\Omega$    |                              |      |
| $C_{i(c)}$ Common-mode input capacitance  | f = 10 kHz, P package  | 25°C                       | 8                     |           |     | 8                       | pF          |                              |      |
| $z_o$ Closed-loop output impedance  | f = 100 kHz, $A_V = 10$  | 25°C                       | 220                   |           |     | 220                     | $\Omega$    |                              |      |
| CMRR Common-mode rejection ratio  | $V_{IC} = -5\ \text{V to } 2.7\ \text{V},$<br>$V_O = 0, \quad R_S = 50\ \Omega$    | 25°C                       | 75                    | 88        |     | 75                      | 88          | dB                           |      |
|   |  | Full range                 | 75                    |           |     | 75                      |             |                              |      |
| $k_{SVR}$ Supply-voltage rejection ratio ( $\Delta V_{DD\pm} / \Delta V_{IO}$ ) | $V_{DD} = 4.4\ \text{V to } 16\ \text{V},$<br>$V_{IC} = V_{DD}/2, \text{ No load}$ | 25°C                       | 80                    | 95        |     | 80                      | 95          | dB                           |      |
|   |  | Full range                 | 80                    |           |     | 80                      |             |                              |      |
| $I_{DD}$ Supply current   | $V_O = 0, \quad \text{No load}$  | 25°C                       | 425                   | 500       |     | 425                     | 500         | $\mu\text{A}$                |      |
|   |  | Full range                 |                       | 500       |     |                         | 500         |                              |      |

† Full range is -40°C to 125°C for Q suffix, -55°C to 125°C for M suffix.

NOTE 4: Typical values are based on the input offset voltage shift observed through 500 hours of operating life test at  $T_A = 150^\circ\text{C}$  extrapolated to  $T_A = 25^\circ\text{C}$  using the Arrhenius equation and assuming an activation energy of 0.96 eV.



**TLC2262Q/M operating characteristics at specified free-air temperature,  $V_{DD\pm} = \pm 5\text{ V}$**

| PARAMETER   | TEST CONDITIONS   | $T_A$ †                              | TLC2262Q,<br>TLC2262M |        |      | TLC2262AQ,<br>TLC2262AM |        |      | UNIT             |                        |
|-------------|---|--------------------------------------|-----------------------|--------|------|-------------------------|--------|------|------------------|------------------------|
|             |   |                                      | MIN                   | TYP    | MAX  | MIN                     | TYP    | MAX  |                  |                        |
| SR          | Slew rate at unity gain<br>$V_O = \pm 2\text{ V}$ ,<br>$C_L = 100\text{ pF}$  | $R_L = 50\text{ k}\Omega$            | 25°C                  | 0.35   | 0.55 |                         | 0.35   | 0.55 | V/ $\mu\text{s}$ |                        |
|             |   |                                      | Full range            | 0.25   |      |                         | 0.25   |      |                  |                        |
| $V_n$       | Equivalent input noise voltage  |                                      | 25°C                  | 43     |      |                         | 43     |      |                  | nV/ $\sqrt{\text{Hz}}$ |
|             |   |                                      | 25°C                  | 12     |      |                         | 12     |      |                  |                        |
| $V_{N(PP)}$ | Peak-to-peak equivalent input noise voltage   |                                      | 25°C                  | 0.8    |      |                         | 0.8    |      |                  | $\mu\text{V}$          |
|             |   |                                      | 25°C                  | 1.3    |      |                         | 1.3    |      |                  |                        |
| $I_n$       | Equivalent input noise current  |                                      | 25°C                  | 0.6    |      |                         | 0.6    |      |                  | fA $\sqrt{\text{Hz}}$  |
| THD + N     | Total harmonic distortion plus noise<br>$V_O = \pm 2.3\text{ V}$ ,<br>$R_L = 50\text{ k}\Omega$ ,<br>$f = 20\text{ kHz}$            | $A_V = 1$                            | 25°C                  | 0.014% |      |                         | 0.014% |      |                  |                        |
|             |   |                                      | $A_V = 10$            | 0.024% |      |                         | 0.024% |      |                  |                        |
|             | Gain-bandwidth product<br>$f = 10\text{ kHz}$ ,<br>$C_L = 100\text{ pF}$  | $R_L = 50\text{ k}\Omega$            | 25°C                  | 0.73   |      |                         | 0.73   |      |                  | MHz                    |
| $B_{OM}$    | Maximum output-swing bandwidth<br>$V_{O(PP)} = 4.6\text{ V}$ ,<br>$R_L = 50\text{ k}\Omega$   | $A_V = 1$ ,<br>$C_L = 100\text{ pF}$ | 25°C                  | 85     |      |                         | 85     |      |                  | kHz                    |
| $t_s$       | Settling time<br>$A_V = -1$ ,<br>Step = $-2.3\text{ V}$ to $2.3\text{ V}$ ,<br>$R_L = 50\text{ k}\Omega$ ,<br>$C_L = 100\text{ pF}$ | To 0.1%                              | 25°C                  | 7.1    |      |                         | 7.1    |      |                  | $\mu\text{s}$          |
|             |   | To 0.01%                             |                       | 16.5   |      |                         | 16.5   |      |                  |                        |
| $\phi_m$    | Phase margin at unity gain<br>$R_L = 50\text{ k}\Omega$   | $C_L = 100\text{ pF}$                | 25°C                  | 57°    |      |                         | 57°    |      |                  |                        |
|             | Gain margin   |                                      | 25°C                  | 11     |      |                         | 11     |      |                  |                        |

† Full range is  $-40^\circ\text{C}$  to  $125^\circ\text{C}$  for Q suffix,  $-55^\circ\text{C}$  to  $125^\circ\text{C}$  for M suffix.

# TLC226x, TLC226xA Advanced LinCMOS™ RAIL-TO-RAIL OPERATIONAL AMPLIFIERS

SLOS177D – FEBRUARY 1997 – REVISED MARCH 2001

**TLC2264Q/M electrical characteristics at specified free-air temperature,  $V_{DD} = 5\text{ V}$  (unless otherwise noted)**

| PARAMETER  | TEST CONDITIONS  | $T_A$ †                             | TLC2264Q,<br>TLC2264M |             |          | TLC2264AQ,<br>TLC2264AM |             |               | UNIT                         |
|--|--|-------------------------------------|-----------------------|-------------|----------|-------------------------|-------------|---------------|------------------------------|
|  |  |                                     | MIN                   | TYP         | MAX      | MIN                     | TYP         | MAX           |                              |
| $V_{IO}$ Input offset voltage  |  | 25°C                                | 300                   | 2500        |          | 300                     | 950         | $\mu\text{V}$ |                              |
|  |  | Full range                          |                       |             | 3000     |                         | 1500        |               |                              |
| $\alpha_{VIO}$ Temperature coefficient of input offset voltage             |  | Full range                          | 2                     |             |          | 2                       |             |               | $\mu\text{V}/^\circ\text{C}$ |
| Input offset voltage long-term drift (see Note 4)                          | $V_{DD\pm} = \pm 2.5\text{ V}$ ,<br>$V_O = 0$ ,<br>$V_{IC} = 0$ ,<br>$R_S = 50\ \Omega$                          | 25°C                                | 0.003                 |             |          | 0.003                   |             |               | $\mu\text{V}/\text{mo}$      |
| $I_{IO}$ Input offset current  |  | 25°C                                | 0.5                   |             |          | 0.5                     |             |               | $\text{pA}$                  |
|  |  | 125°C                               | 800                   |             |          | 800                     |             |               |                              |
| $I_{IB}$ Input bias current  |  | 25°C                                | 1                     |             |          | 1                       |             |               | $\text{pA}$                  |
|  | 125°C  | 800                                 |                       |             | 800      |                         |             |               |                              |
| $V_{ICR}$ Common-mode input voltage range                                  | $R_S = 50\ \Omega$ ,<br>$ V_{IO}  \leq 5\text{ mV}$  | 25°C                                | 0 to 4                | -0.3 to 4.2 |          | 0 to 4                  | -0.3 to 4.2 | $\text{V}$    |                              |
|  |  | Full range                          | 0 to 3.5              |             | 0 to 3.5 |                         |             |               |                              |
| $V_{OH}$ High-level output voltage   | $I_{OH} = -20\ \mu\text{A}$<br>$I_{OH} = -100\ \mu\text{A}$<br>$I_{OH} = -400\ \mu\text{A}$                      | 25°C                                | 4.99                  |             |          | 4.99                    |             |               | $\text{V}$                   |
|  |  | 25°C                                | 4.85                  | 4.94        |          | 4.85                    | 4.94        |               |                              |
|  |  | Full range                          | 4.82                  |             |          | 4.82                    |             |               |                              |
|  |  | 25°C                                | 4.7                   | 4.85        |          | 4.7                     | 4.85        |               |                              |
| $V_{OL}$ Low-level output voltage  | $V_{IC} = 2.5\text{ V}$ ,<br>$I_{OL} = 50\ \mu\text{A}$<br>$I_{OL} = 500\ \mu\text{A}$<br>$I_{OL} = 4\text{ mA}$ | 25°C                                | 0.01                  |             |          | 0.01                    |             |               | $\text{V}$                   |
|  |  | 25°C                                | 0.09                  | 0.15        |          | 0.09                    | 0.15        |               |                              |
|  |  | Full range                          | 0.15                  |             |          | 0.15                    |             |               |                              |
|  |  | 25°C                                | 0.8                   | 1           |          | 0.7                     | 1           |               |                              |
| $AVD$ Large-signal differential voltage amplification                      | $V_{IC} = 2.5\text{ V}$ ,<br>$V_O = 1\text{ V to } 4\text{ V}$   | $R_L = 50\ \text{k}\Omega^\ddagger$ | 25°C                  | 80          | 100      |                         | 80          | 170           | $\text{V}/\text{mV}$         |
|  |  |                                     | Full range            | 50          |          |                         | 50          |               |                              |
|  |  | $R_L = 1\ \text{M}\Omega^\ddagger$  | 25°C                  | 550         |          |                         | 550         |               |                              |
| $r_{i(d)}$ Differential input resistance                                   |  | 25°C                                | $10^{12}$             |             |          | $10^{12}$               |             |               | $\Omega$                     |
| $r_{i(c)}$ Common-mode input resistance                                    |  | 25°C                                | $10^{12}$             |             |          | $10^{12}$               |             |               | $\Omega$                     |
| $C_{i(c)}$ Common-mode input capacitance                                   | $f = 10\ \text{kHz}$ ,<br>N package  | 25°C                                | 8                     |             |          | 8                       |             |               | $\text{pF}$                  |
| $z_o$ Closed-loop output impedance   | $f = 100\ \text{kHz}$ ,<br>$A_V = 10$  | 25°C                                | 240                   |             |          | 240                     |             |               | $\Omega$                     |
| CMRR Common-mode rejection ratio   | $V_{IC} = 0\text{ to } 2.7\text{ V}$ ,<br>$V_O = 2.5\text{ V}$ ,<br>$R_S = 50\ \Omega$                           | 25°C                                | 70                    | 83          |          | 70                      | 83          | $\text{dB}$   |                              |
|  |  | Full range                          | 70                    |             |          | 70                      |             |               |                              |
| $k_{SVR}$ Supply-voltage rejection ratio ( $\Delta V_{DD}/\Delta V_{IO}$ ) | $V_{DD} = 4.4\text{ V to } 16\text{ V}$ ,  | 25°C                                | 80                    | 95          |          | 80                      | 95          | $\text{dB}$   |                              |
| $I_{DD}$ Supply current (four amplifiers)                                  | $V_O = 2.5\text{ V}$ ,<br>No load  | 25°C                                | 0.8                   | 1           |          | 0.8                     | 1           | $\text{mA}$   |                              |
|  |  | Full range                          | 1                     |             |          | 1                       |             |               |                              |

† Full range is  $-40^\circ\text{C}$  to  $125^\circ\text{C}$  for Q suffix,  $-55^\circ\text{C}$  to  $125^\circ\text{C}$  for M suffix.

‡ Referenced to 2.5 V

NOTE 4: Typical values are based on the input offset voltage shift observed through 500 hours of operating life test at  $T_A = 150^\circ\text{C}$  extrapolated to  $T_A = 25^\circ\text{C}$  using the Arrhenius equation and assuming an activation energy of 0.96 eV.



**TLC2264Q/M operating characteristics at specified free-air temperature,  $V_{DD} = 5\text{ V}$**

| PARAMETER   | TEST CONDITIONS  | $T_A$ †  | TLC2264Q,<br>TLC2264M |      |     | TLC2264AQ,<br>TLC2264AM |      |     | UNIT                   |
|-------------|--|--|-----------------------|------|-----|-------------------------|------|-----|------------------------|
|             |  |  | MIN                   | TYP  | MAX | MIN                     | TYP  | MAX |                        |
| SR          | Slew rate at unity gain<br>$V_O = 0.5\text{ V to }3.5\text{ V}, R_L = 50\text{ k}\Omega^\ddagger, C_L = 100\text{ pF}^\ddagger$          | 25°C   | 0.35                  | 0.55 |     | 0.35                    | 0.55 |     | V/ $\mu\text{s}$       |
|             |  | Full range   | 0.25                  |      |     | 0.25                    |      |     |                        |
| $V_n$       | Equivalent input noise voltage   | f = 10 Hz  | 40                    |      |     | 40                      |      |     | nV/ $\sqrt{\text{Hz}}$ |
|             |  | f = 1 kHz  | 12                    |      |     | 12                      |      |     |                        |
| $V_{N(PP)}$ | Peak-to-peak equivalent input noise voltage  | f = 0.1 Hz to 1 Hz                                   | 0.7                   |      |     | 0.7                     |      |     | $\mu\text{V}$          |
|             |  | f = 0.1 Hz to 10 Hz                                  | 1.3                   |      |     | 1.3                     |      |     |                        |
| $I_n$       | Equivalent input noise current   | 25°C   | 0.6                   |      |     | 0.6                     |      |     | fA/ $\sqrt{\text{Hz}}$ |
| THD + N     | Total harmonic distortion plus noise<br>$V_O = 0.5\text{ V to }2.5\text{ V}, f = 20\text{ kHz}, R_L = 50\text{ k}\Omega^\ddagger$        | $A_V = 1$  | 0.017%                |      |     | 0.017%                  |      |     |                        |
|             |  | $A_V = 10$   | 0.03%                 |      |     | 0.03%                   |      |     |                        |
|             | Gain-bandwidth product<br>f = 50 kHz, $C_L = 100\text{ pF}^\ddagger$   | $R_L = 50\text{ k}\Omega^\ddagger, 25^\circ\text{C}$ | 0.71                  |      |     | 0.71                    |      |     | MHz                    |
| $B_{OM}$    | Maximum output-swing bandwidth<br>$V_{O(PP)} = 2\text{ V}, R_L = 50\text{ k}\Omega^\ddagger, A_V = 1, C_L = 100\text{ pF}^\ddagger$      | 25°C   | 185                   |      |     | 185                     |      |     | kHz                    |
| $t_s$       | Settling time<br>$A_V = -1, \text{ Step} = 0.5\text{ V to }2.5\text{ V}, R_L = 50\text{ k}\Omega^\ddagger, C_L = 100\text{ pF}^\ddagger$ | To 0.1%  | 6.4                   |      |     | 6.4                     |      |     | $\mu\text{s}$          |
|             |  | To 0.01%   | 14.1                  |      |     | 14.1                    |      |     |                        |
| $\phi_m$    | Phase margin at unity gain<br>$R_L = 50\text{ k}\Omega^\ddagger, C_L = 100\text{ pF}^\ddagger$   | 25°C   | 56°                   |      |     | 56°                     |      |     |                        |
|             |  | 25°C   | 11                    |      |     | 11                      |      |     |                        |

† Full range is  $-40^\circ\text{C}$  to  $125^\circ\text{C}$  for Q suffix,  $-55^\circ\text{C}$  to  $125^\circ\text{C}$  for M suffix.

‡ Referenced to 2.5 V

# TLC226x, TLC226xA Advanced LinCMOS™ RAIL-TO-RAIL OPERATIONAL AMPLIFIERS

SLOS177D – FEBRUARY 1997 – REVISED MARCH 2001

**TLC2264Q/M electrical characteristics at specified free-air temperature,  $V_{DD\pm} = \pm 5\text{ V}$  (unless otherwise noted)**

| PARAMETER   | TEST CONDITIONS  | $T_A$ †                    | TLC2264Q,<br>TLC2264M |             |      | TLC2264AQ,<br>TLC2264AM |             |                              | UNIT |
|---|--|----------------------------|-----------------------|-------------|------|-------------------------|-------------|------------------------------|------|
|   |  |                            | MIN                   | TYP         | MAX  | MIN                     | TYP         | MAX                          |      |
| $V_{IO}$ Input offset voltage   | $V_{IC} = 0, V_O = 0, R_S = 50\ \Omega$  | 25°C                       | 300                   | 2500        |      | 300                     | 950         | $\mu\text{V}$                |      |
|   |  | Full range                 |                       |             | 3000 |                         | 1500        |                              |      |
| $\alpha_{VIO}$ Temperature coefficient of input offset voltage                |  | Full range                 |                       | 2           |      |                         | 2           | $\mu\text{V}/^\circ\text{C}$ |      |
| Input offset voltage long-term drift (see Note 4)                             |  | 25°C                       |                       | 0.003       |      |                         | 0.003       | $\mu\text{V}/\text{mo}$      |      |
| $I_{IO}$ Input offset current   |  | 25°C                       |                       | 0.5         |      |                         | 0.5         | pA                           |      |
|   |  | 125°C                      |                       |             | 800  |                         | 800         |                              |      |
| $I_{IB}$ Input bias current   | 25°C   |                            | 1                     |             |      | 1                       | pA          |                              |      |
|   | 125°C  |                            |                       | 800         |      | 800                     |             |                              |      |
| $V_{ICR}$ Common-mode input voltage range                                     | $R_S = 50\ \Omega,  V_{IO}  \leq 5\ \text{mV}$   | 25°C                       | -5 to 4               | -5.3 to 4.2 |      | -5 to 4                 | -5.3 to 4.2 | V                            |      |
|   |  | Full range                 | -5 to 3.5             |             |      | -5 to 3.5               |             |                              |      |
| $V_{OM+}$ Maximum positive peak output voltage                                | $I_O = -20\ \mu\text{A}$   | 25°C                       |                       | 4.99        |      |                         | 4.99        | V                            |      |
|   | $I_O = -100\ \mu\text{A}$  | 25°C                       | 4.85                  | 4.94        |      | 4.85                    | 4.94        |                              |      |
|   |  | Full range                 | 4.82                  |             |      | 4.82                    |             |                              |      |
|   | $I_O = -400\ \mu\text{A}$  | 25°C                       | 4.7                   | 4.85        |      | 4.7                     | 4.85        |                              |      |
| Full range  |  | 4.5                        |                       |             | 4.5  |                         |             |                              |      |
| $V_{OM-}$ Maximum negative peak output voltage                                | $V_{IC} = 0, I_O = 50\ \mu\text{A}$  | 25°C                       |                       | -4.99       |      |                         | -4.99       | V                            |      |
|   | $V_{IC} = 0, I_O = 500\ \mu\text{A}$   | 25°C                       | -4.85                 | -4.91       |      | -4.85                   | -4.91       |                              |      |
|   |  | Full range                 | -4.85                 |             |      | -4.85                   |             |                              |      |
|   | $V_{IC} = 0, I_O = 4\ \text{mA}$   | 25°C                       | -4                    | -4.3        |      | -4                      | -4.3        |                              |      |
| Full range  |  | -3.8                       |                       |             | -3.8 |                         |             |                              |      |
| $A_{VD}$ Large-signal differential voltage amplification                      | $V_O = \pm 4\ \text{V}$  | $R_L = 50\ \text{k}\Omega$ | 25°C                  | 80          | 200  |                         | 80          | 200                          | V/mV |
|   |  |                            | Full range            | 50          |      |                         | 50          |                              |      |
|   |  | $R_L = 1\ \text{M}\Omega$  | 25°C                  |             | 1000 |                         |             | 1000                         |      |
| $r_{i(d)}$ Differential input resistance                                      |  | 25°C                       |                       | $10^{12}$   |      |                         | $10^{12}$   | $\Omega$                     |      |
| $r_{i(c)}$ Common-mode input resistance                                       |  | 25°C                       |                       | $10^{12}$   |      |                         | $10^{12}$   | $\Omega$                     |      |
| $C_{i(c)}$ Common-mode input capacitance                                      | $f = 10\ \text{kHz}, \text{N package}$   | 25°C                       |                       | 8           |      |                         | 8           | pF                           |      |
| $z_o$ Closed-loop output impedance  | $f = 100\ \text{kHz}, A_V = 10$  | 25°C                       |                       | 220         |      |                         | 220         | $\Omega$                     |      |
| CMRR Common-mode rejection ratio  | $V_{IC} = -5\ \text{V to } 2.7\ \text{V}, V_O = 0, R_S = 50\ \Omega$                   | 25°C                       | 75                    | 88          |      | 75                      | 88          | dB                           |      |
|   |  | Full range                 | 75                    |             |      | 75                      |             |                              |      |
| $k_{SVR}$ Supply-voltage rejection ratio ( $\Delta V_{DD\pm}/\Delta V_{IO}$ ) | $V_{DD\pm} = \pm 2.2\ \text{V to } \pm 8\ \text{V}, V_{IC} = V_{DD}/2, \text{No load}$ | 25°C                       | 80                    | 95          |      | 80                      | 95          | dB                           |      |
|   |  | Full range                 | 80                    |             |      | 80                      |             |                              |      |
| $I_{DD}$ Supply current (four amplifiers)                                     | $V_O = 0, \text{No load}$  | 25°C                       |                       | 0.85        | 1    |                         | 0.85        | 1                            | mA   |
|   |  | Full range                 |                       |             | 1    |                         |             | 1                            |      |

† Full range is  $-40^\circ\text{C}$  to  $125^\circ\text{C}$  for Q suffix,  $-55^\circ\text{C}$  to  $125^\circ\text{C}$  for M suffix.

NOTE 4: Typical values are based on the input offset voltage shift observed through 500 hours of operating life test at  $T_A = 150^\circ\text{C}$  extrapolated to  $T_A = 25^\circ\text{C}$  using the Arrhenius equation and assuming an activation energy of 0.96 eV.



**TLC2264Q/M operating characteristics at specified free-air temperature,  $V_{DD\pm} = \pm 5\text{ V}$**

| PARAMETER   | TEST CONDITIONS   | $T_A$ †                              | TLC2264Q,<br>TLC2264M |            |      | TLC2264AQ,<br>TLC2264AM |        |      | UNIT             |                        |
|-------------|---|--------------------------------------|-----------------------|------------|------|-------------------------|--------|------|------------------|------------------------|
|             |   |                                      | MIN                   | TYP        | MAX  | MIN                     | TYP    | MAX  |                  |                        |
| SR          | Slew rate at unity gain<br>$V_O = \pm 2\text{ V}$ ,<br>$C_L = 100\text{ pF}$  | $R_L = 50\text{ k}\Omega$            | 25°C                  | 0.35       | 0.55 |                         | 0.35   | 0.55 | V/ $\mu\text{s}$ |                        |
|             |   |                                      | Full range            | 0.25       |      | 0.25                    |        |      |                  |                        |
| $V_n$       | Equivalent input noise voltage  |                                      | 25°C                  | 43         |      |                         | 43     |      |                  | nV/ $\sqrt{\text{Hz}}$ |
|             |   |                                      | 25°C                  | 12         |      |                         | 12     |      |                  |                        |
| $V_{N(PP)}$ | Peak-to-peak equivalent input noise voltage   |                                      | 25°C                  | 0.8        |      |                         | 0.8    |      |                  | $\mu\text{V}$          |
|             |   |                                      | 25°C                  | 1.3        |      |                         | 1.3    |      |                  |                        |
| $I_n$       | Equivalent input noise current  |                                      | 25°C                  | 0.6        |      |                         | 0.6    |      |                  | fA/ $\sqrt{\text{Hz}}$ |
| THD + N     | Total harmonic distortion plus noise<br>$V_O = \pm 2.3\text{ V}$ ,<br>$R_L = 50\text{ k}\Omega$ ,<br>$f = 20\text{ kHz}$            |                                      | 25°C                  | $A_V = 1$  |      |                         | 0.014% |      |                  |                        |
|             |   |                                      |                       | $A_V = 10$ |      |                         | 0.024% |      |                  |                        |
|             | Gain-bandwidth product<br>$f = 10\text{ kHz}$ ,<br>$C_L = 100\text{ pF}$  | $R_L = 50\text{ k}\Omega$            | 25°C                  | 0.73       |      |                         | 0.73   |      |                  | MHz                    |
| $B_{OM}$    | Maximum output-swing bandwidth<br>$V_{O(PP)} = 4.6\text{ V}$ ,<br>$R_L = 50\text{ k}\Omega$   | $A_V = 1$ ,<br>$C_L = 100\text{ pF}$ | 25°C                  | 70         |      |                         | 70     |      |                  | kHz                    |
| $t_s$       | Settling time<br>$A_V = -1$ ,<br>Step = $-2.3\text{ V}$ to $2.3\text{ V}$ ,<br>$R_L = 50\text{ k}\Omega$ ,<br>$C_L = 100\text{ pF}$ |                                      | 25°C                  | To 0.1%    |      |                         | 7.1    |      |                  | $\mu\text{s}$          |
|             |   |                                      |                       | To 0.01%   |      |                         | 16.5   |      |                  |                        |
| $\phi_m$    | Phase margin at unity gain<br>$R_L = 50\text{ k}\Omega$   | $C_L = 100\text{ pF}$                | 25°C                  | 57°        |      |                         | 57°    |      |                  |                        |
|             | Gain margin   |                                      | 25°C                  | 11         |      |                         | 11     |      |                  | dB                     |

† Full range is  $-40^\circ\text{C}$  to  $125^\circ\text{C}$  for Q suffix,  $-55^\circ\text{C}$  to  $125^\circ\text{C}$  for M suffix.

**TLC226x, TLC226xA**  
**Advanced LinCMOS™ RAIL-TO-RAIL**  
**OPERATIONAL AMPLIFIERS**

SLOS177D – FEBRUARY 1997 – REVISED MARCH 2001

**TYPICAL CHARACTERISTICS**

**Table of Graphs**

|                 |   |  | <b>FIGURE</b>    |
|-----------------|---|--|------------------|
| $V_{IO}$        | Input offset voltage                            | Distribution<br>vs Common-mode input voltage   | 2 – 5<br>6, 7    |
| $\alpha V_{IO}$ | Input offset voltage temperature coefficient    | Distribution                                   | 8 – 11           |
| $I_{IB}/I_{IO}$ | Input bias and input offset currents            | vs Free-air temperature                        | 12               |
| $V_I$           | Input voltage range                             | vs Supply voltage<br>vs Free-air temperature   | 13<br>14         |
| $V_{OH}$        | High-level output voltage                       | vs High-level output current                   | 15               |
| $V_{OL}$        | Low-level output voltage                        | vs Low-level output current                    | 16, 17           |
| $V_{OM+}$       | Maximum positive output voltage                 | vs Output current                              | 18               |
| $V_{OM-}$       | Maximum negative output voltage                 | vs Output current                              | 19               |
| $V_{O(PP)}$     | Maximum peak-to-peak output voltage             | vs Frequency                                   | 20               |
| $I_{OS}$        | Short-circuit output current                    | vs Supply voltage<br>vs Free-air temperature   | 21<br>22         |
| $V_O$           | Output voltage                                  | vs Differential input voltage                  | 23, 24           |
|                 | Differential gain                               | vs Load resistance                             | 25               |
| $A_{VD}$        | Large-signal differential voltage amplification | vs Frequency<br>vs Free-air temperature        | 26, 27<br>28, 29 |
| $z_o$           | Output impedance                                | vs Frequency                                   | 30, 31           |
| CMRR            | Common-mode rejection ratio                     | vs Frequency<br>vs Free-air temperature        | 32<br>33         |
| $k_{SVR}$       | Supply-voltage rejection ratio                  | vs Frequency<br>vs Free-air temperature        | 34, 35<br>36     |
| $I_{DD}$        | Supply current                                  | vs Supply voltage<br>vs Free-air temperature   | 37, 38<br>39, 40 |
| SR              | Slew rate                                       | vs Load capacitance<br>vs Free-air temperature | 41<br>42         |
| $V_O$           | Inverting large-signal pulse response           |  | 43, 44           |
|                 | Voltage-follower large-signal pulse response    |  | 45, 46           |
|                 | Inverting small-signal pulse response           |  | 47, 48           |
|                 | Voltage-follower small-signal pulse response    |  | 49, 50           |
| $V_n$           | Equivalent input noise voltage                  | vs Frequency                                   | 51, 52           |
|                 | Noise voltage (referred to input)               | Over a 10-second period                        | 53               |
|                 | Integrated noise voltage                        | vs Frequency                                   | 54               |
| THD + N         | Total harmonic distortion plus noise            | vs Frequency                                   | 55               |
|                 | Gain-bandwidth product                          | vs Supply voltage<br>vs Free-air temperature   | 56<br>57         |
| $\phi_m$        | Phase margin                                    | vs Frequency<br>vs Load capacitance            | 26, 27<br>58     |
|                 | Gain margin                                     | vs Load capacitance                            | 59               |
| $B_1$           | Unity-gain bandwidth                            | vs Load capacitance                            | 60               |
|                 | Overestimation of phase margin                  | vs Load capacitance                            | 61               |



TYPICAL CHARACTERISTICS

DISTRIBUTION OF TLC2262  
 INPUT OFFSET VOLTAGE



Figure 2

DISTRIBUTION OF TLC2262  
 INPUT OFFSET VOLTAGE



Figure 3

DISTRIBUTION OF TLC2264  
 INPUT OFFSET VOLTAGE



Figure 4

DISTRIBUTION OF TLC2264  
 INPUT OFFSET VOLTAGE

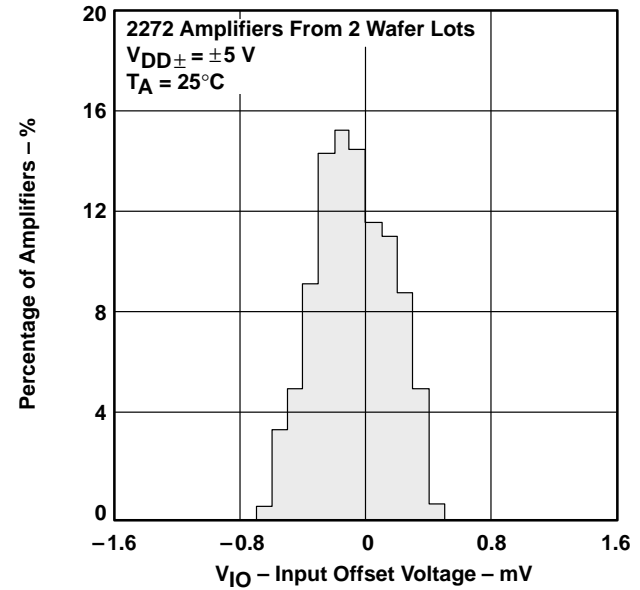

Figure 5

**TYPICAL CHARACTERISTICS**

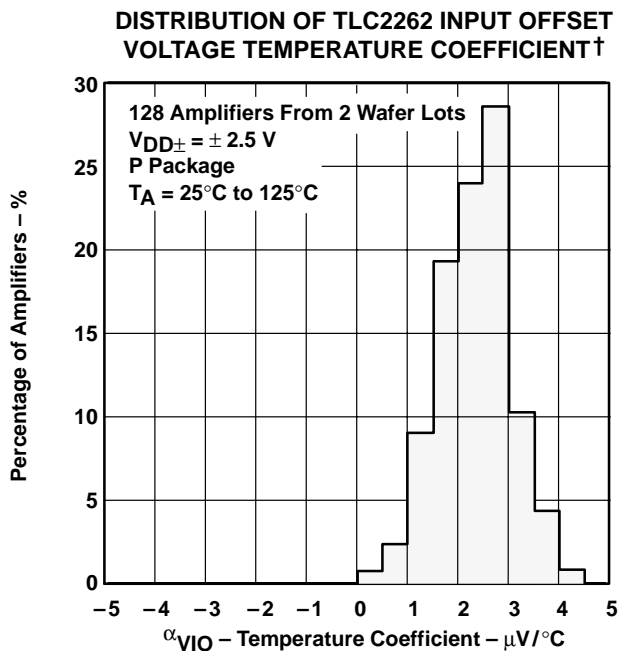

**Figure 6**



**Figure 7**

† For curves where  $V_{DD} = 5\text{ V}$ , all loads are referenced to 2.5 V.



**Figure 8**



**Figure 9**

† Data at high and low temperatures are applicable only within the rated operating free-air temperature ranges of the various devices.

TYPICAL CHARACTERISTICS



Figure 10



Figure 11



Figure 12

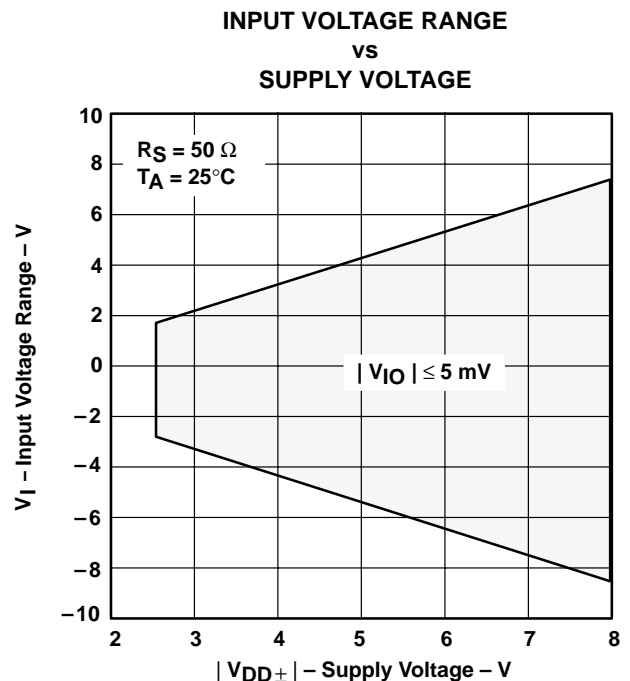

Figure 13

† Data at high and low temperatures are applicable only within the rated operating free-air temperature ranges of the various devices.

TYPICAL CHARACTERISTICS

INPUT VOLTAGE RANGE†‡  
 vs  
 FREE-AIR TEMPERATURE



Figure 14

HIGH-LEVEL OUTPUT VOLTAGE†‡  
 vs  
 HIGH-LEVEL OUTPUT CURRENT



Figure 15

LOW-LEVEL OUTPUT VOLTAGE‡  
 vs  
 LOW-LEVEL OUTPUT CURRENT



Figure 16

LOW-LEVEL OUTPUT VOLTAGE†‡  
 vs  
 LOW-LEVEL OUTPUT CURRENT



Figure 17

† Data at high and low temperatures are applicable only within the rated operating free-air temperature ranges of the various devices.

‡ For curves where  $V_{DD} = 5\text{ V}$ , all loads are referenced to 2.5 V.

TYPICAL CHARACTERISTICS

MAXIMUM POSITIVE OUTPUT VOLTAGE†  
vs  
OUTPUT CURRENT



Figure 18

MAXIMUM NEGATIVE OUTPUT VOLTAGE†  
vs  
OUTPUT CURRENT



Figure 19

MAXIMUM PEAK-TO-PEAK OUTPUT VOLTAGE‡  
vs  
FREQUENCY

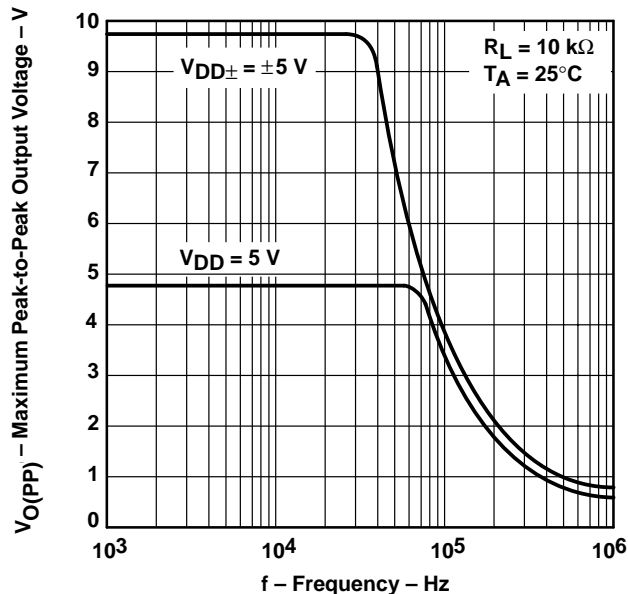

Figure 20

SHORT-CIRCUIT OUTPUT CURRENT  
vs  
SUPPLY VOLTAGE

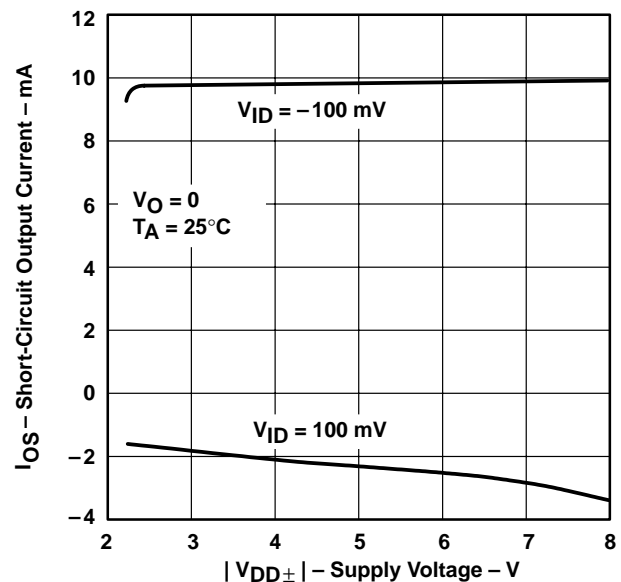

Figure 21

‡ For curves where  $V_{DD} = 5 V$ , all loads are referenced to 2.5 V.

† Data at high and low temperatures are applicable only within the rated operating free-air temperature ranges of the various devices.

**TLC226x, TLC226xA**  
**Advanced LinCMOS™ RAIL-TO-RAIL**  
**OPERATIONAL AMPLIFIERS**

SLOS177D – FEBRUARY 1997 – REVISED MARCH 2001

**TYPICAL CHARACTERISTICS**

**SHORT-CIRCUIT OUTPUT CURRENT †**  
**vs**  
**FREE-AIR TEMPERATURE**



**Figure 22**

**OUTPUT VOLTAGE ‡**  
**vs**  
**DIFFERENTIAL INPUT VOLTAGE**



**Figure 23**

**OUTPUT VOLTAGE**  
**vs**  
**DIFFERENTIAL INPUT VOLTAGE**



**Figure 24**

**DIFFERENTIAL GAIN ‡**  
**vs**  
**LOAD RESISTANCE**

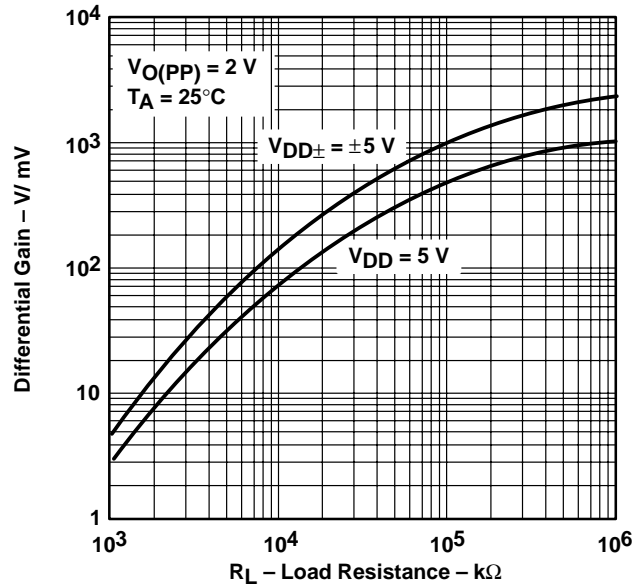

**Figure 25**

† Data at high and low temperatures are applicable only within the rated operating free-air temperature ranges of the various devices.

‡ For curves where  $V_{DD} = 5\text{ V}$ , all loads are referenced to 2.5 V.



TYPICAL CHARACTERISTICS

LARGE-SIGNAL DIFFERENTIAL VOLTAGE†  
 AMPLIFICATION AND PHASE MARGIN  
 VS  
 FREQUENCY



† For curves where  $V_{DD} = 5\text{ V}$ , all loads are referenced to 2.5 V.

Figure 26

LARGE-SIGNAL DIFFERENTIAL VOLTAGE  
 AMPLIFICATION AND PHASE MARGIN  
 VS  
 FREQUENCY

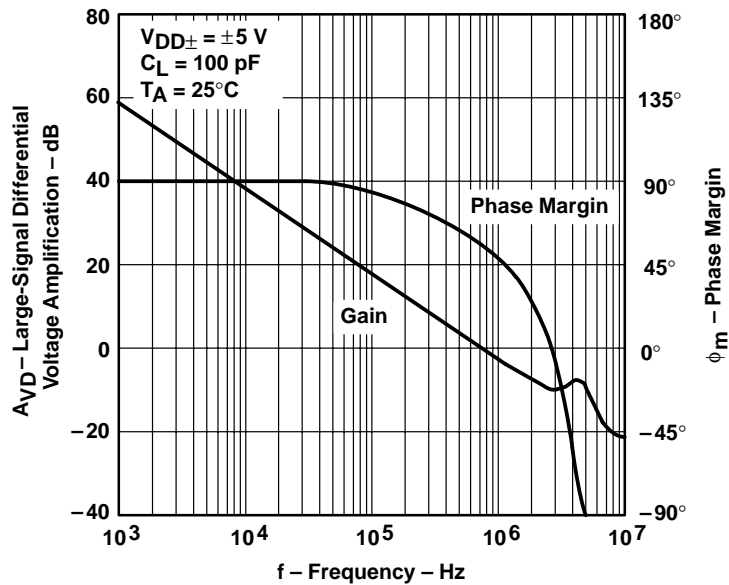

Figure 27

**TYPICAL CHARACTERISTICS**

**LARGE-SIGNAL DIFFERENTIAL VOLTAGE AMPLIFICATION†‡**  
**vs**  
**FREE-AIR TEMPERATURE**



**Figure 28**

**LARGE-SIGNAL DIFFERENTIAL VOLTAGE AMPLIFICATION†**  
**vs**  
**FREE-AIR TEMPERATURE**

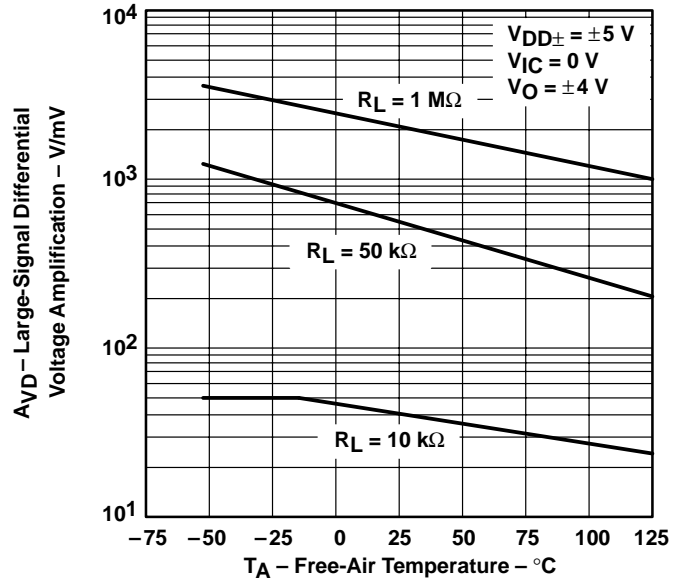

**Figure 29**

**OUTPUT IMPEDANCE‡**  
**vs**  
**FREQUENCY**



**Figure 30**

**OUTPUT IMPEDANCE**  
**vs**  
**FREQUENCY**

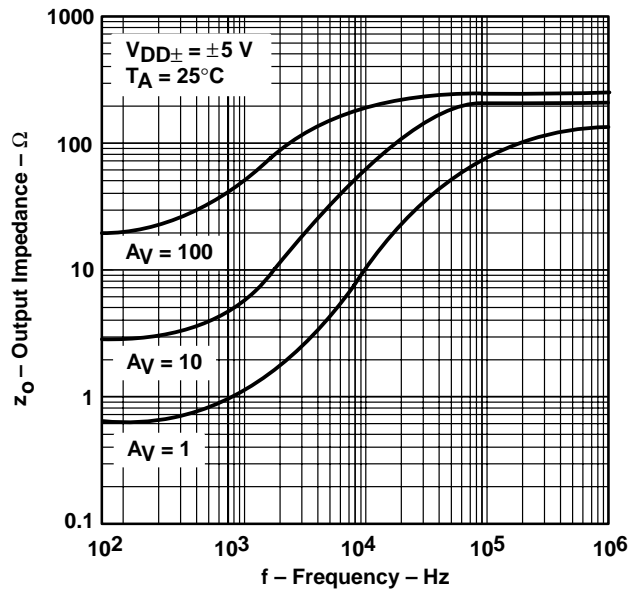
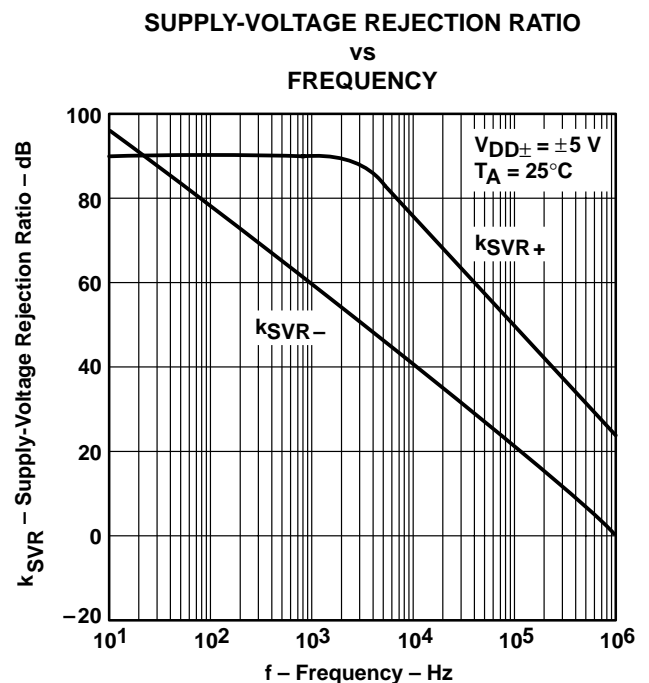
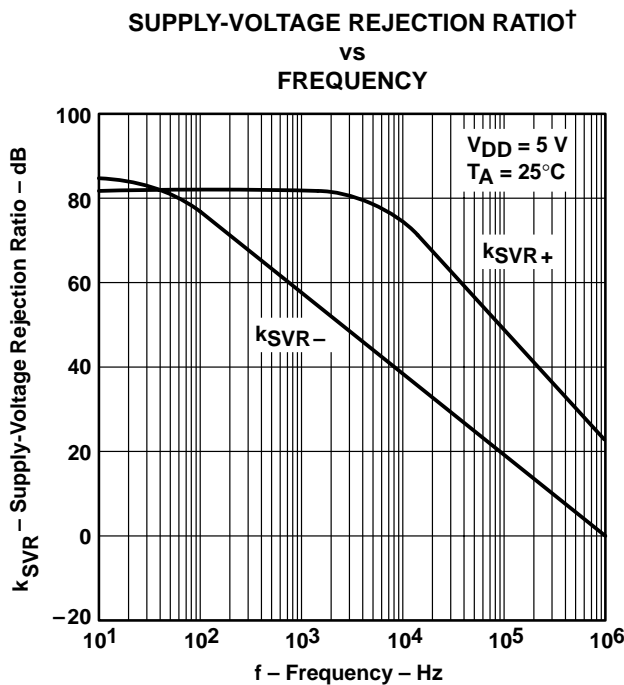
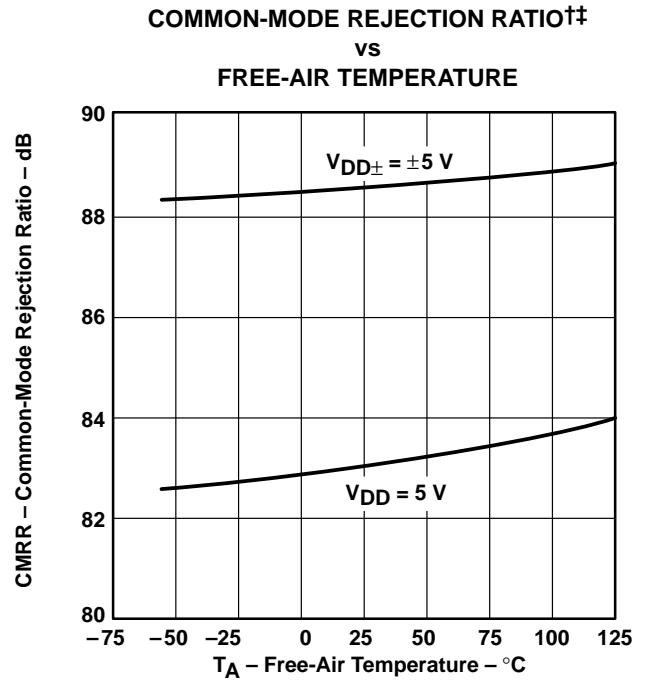

**Figure 31**

† Data at high and low temperatures are applicable only within the rated operating free-air temperature ranges of the various devices.

‡ For curves where  $V_{DD} = 5\text{ V}$ , all loads are referenced to 2.5 V.

TYPICAL CHARACTERISTICS



† For curves where  $V_{DD} = 5\text{ V}$ , all loads are referenced to  $2.5\text{ V}$ .

‡ Data at high and low temperatures are applicable only within the rated operating free-air temperature ranges of the various devices.

**TYPICAL CHARACTERISTICS**



**Figure 36**

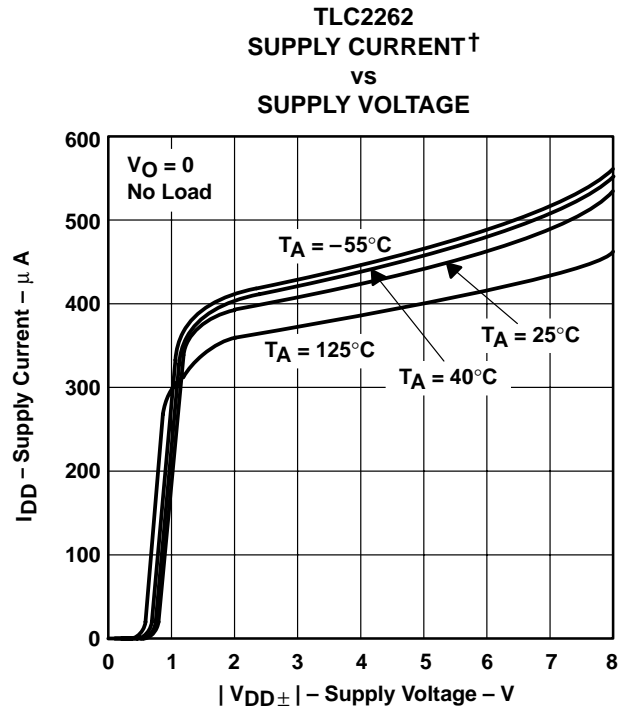

**Figure 37**

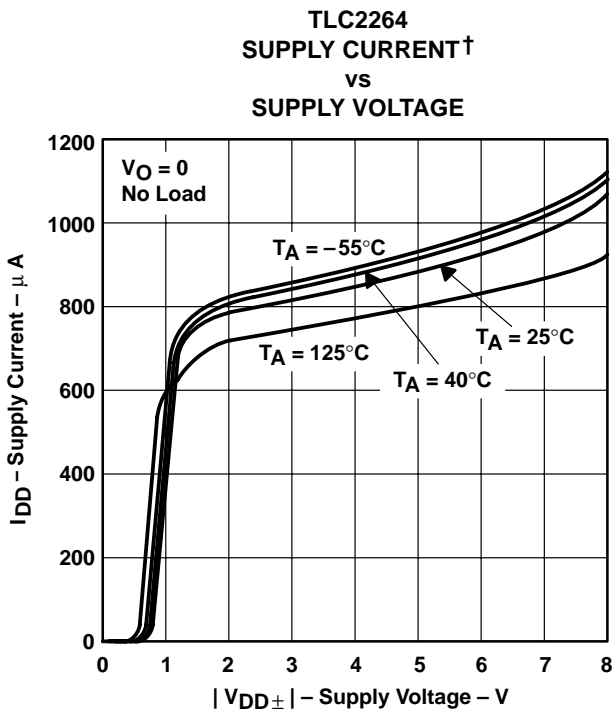

**Figure 38**

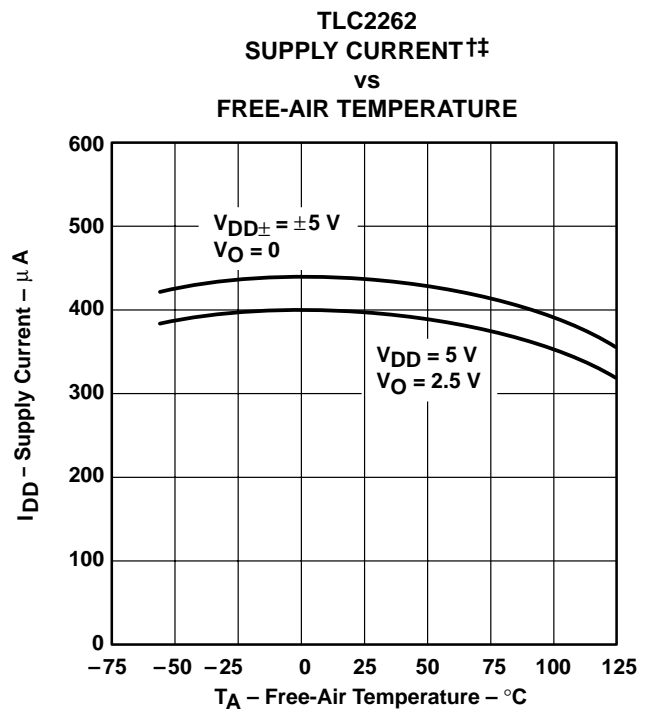

**Figure 39**

† Data at high and low temperatures are applicable only within the rated operating free-air temperature ranges of the various devices.

†† For curves where  $V_{DD} = 5 \text{ V}$ , all loads are referenced to 2.5 V.

TYPICAL CHARACTERISTICS



† Data at high and low temperatures are applicable only within the rated operating free-air temperature ranges of the various devices.

‡ For curves where  $V_{DD} = 5\text{ V}$ , all loads are referenced to 2.5 V.

**TYPICAL CHARACTERISTICS**

**INVERTING LARGE-SIGNAL PULSE RESPONSE**



**Figure 44**

**VOLTAGE-FOLLOWER LARGE-SIGNAL PULSE RESPONSE†**

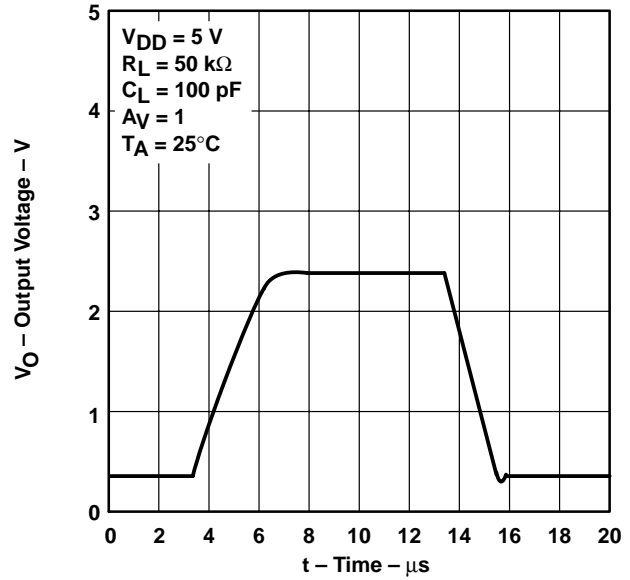

**Figure 45**

**VOLTAGE-FOLLOWER LARGE-SIGNAL PULSE RESPONSE**

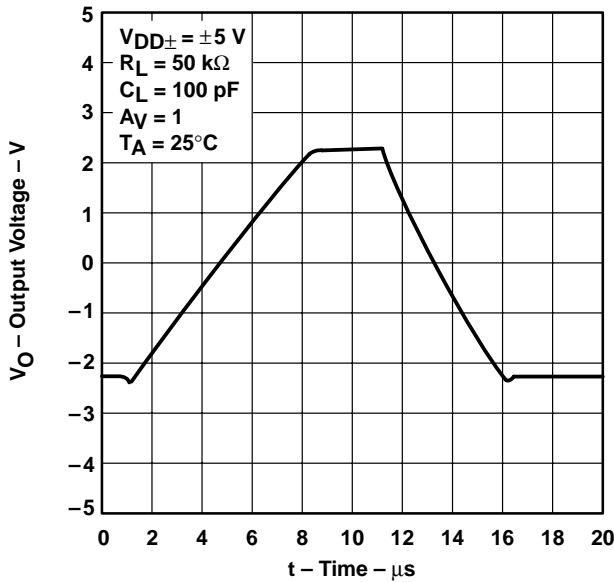

**Figure 46**

**INVERTING SMALL-SIGNAL PULSE RESPONSE†**

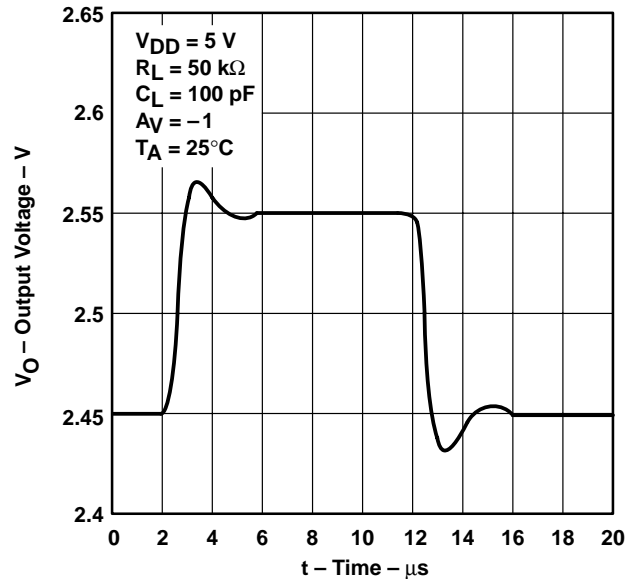

**Figure 47**

† For curves where  $V_{DD} = 5\text{ V}$ , all loads are referenced to 2.5 V.

TYPICAL CHARACTERISTICS

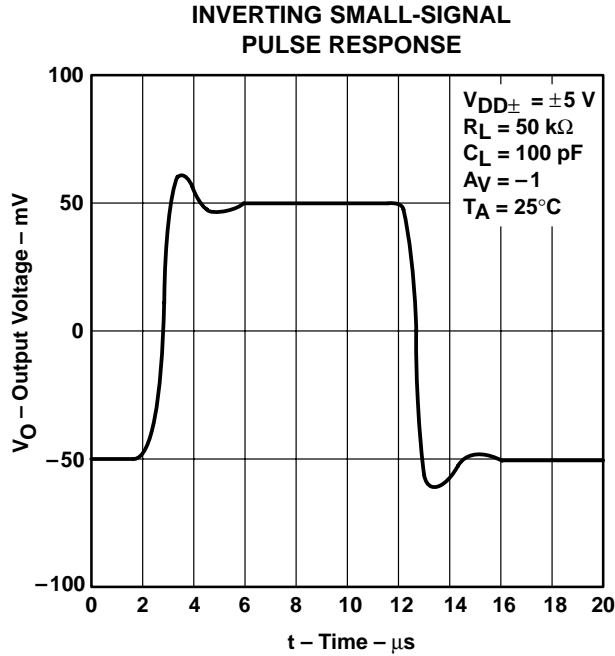

Figure 48

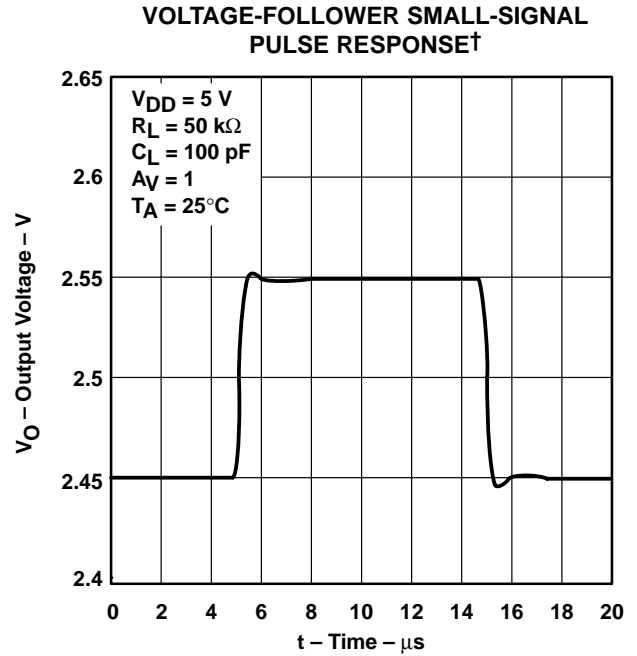

Figure 49

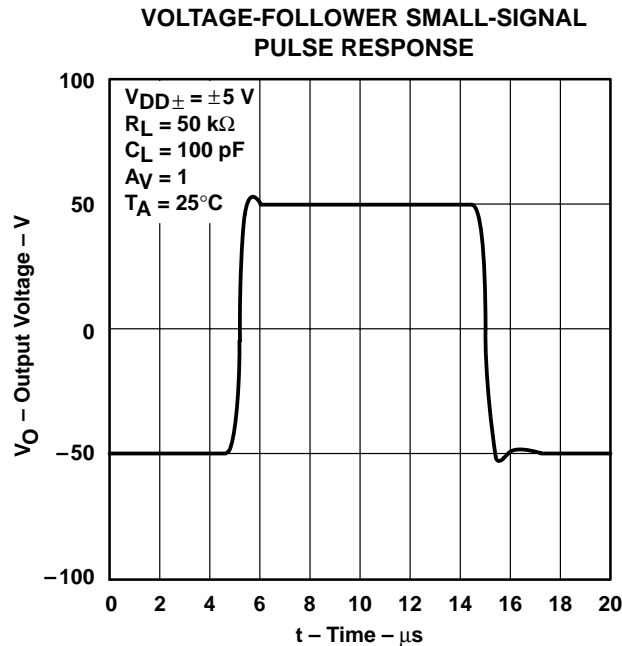

Figure 50

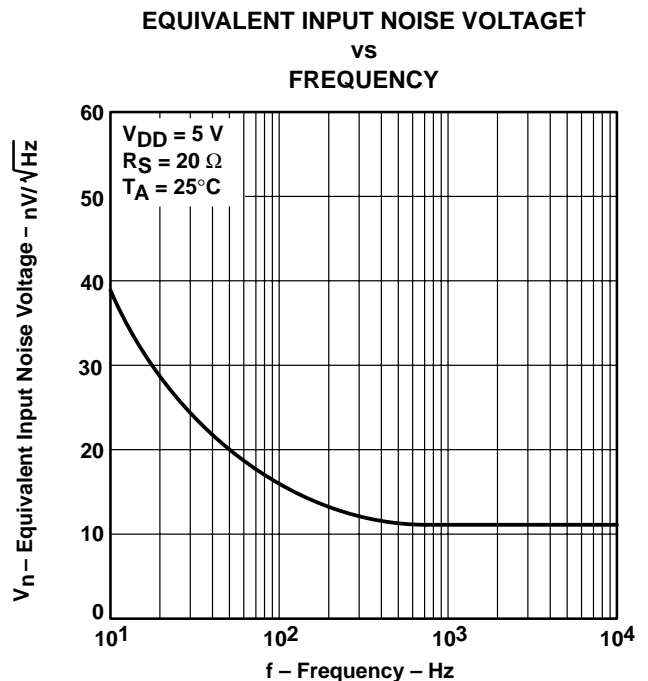

Figure 51

† For curves where  $V_{DD} = 5\text{ V}$ , all loads are referenced to 2.5 V.

TYPICAL CHARACTERISTICS

EQUIVALENT INPUT NOISE VOLTAGE  
 VS  
 FREQUENCY



Figure 52

EQUIVALENT INPUT NOISE VOLTAGE OVER  
 A 10-SECOND PERIOD†



Figure 53

INTEGRATED NOISE VOLTAGE  
 VS  
 FREQUENCY

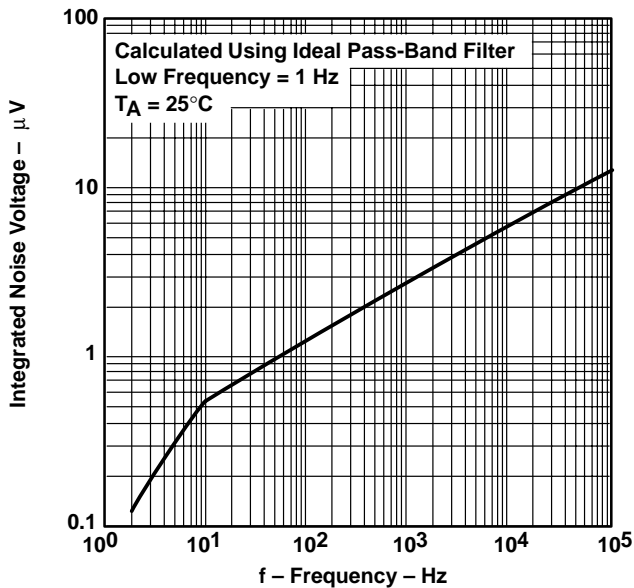

Figure 54

TOTAL HARMONIC DISTORTION PLUS NOISE†  
 VS  
 FREQUENCY

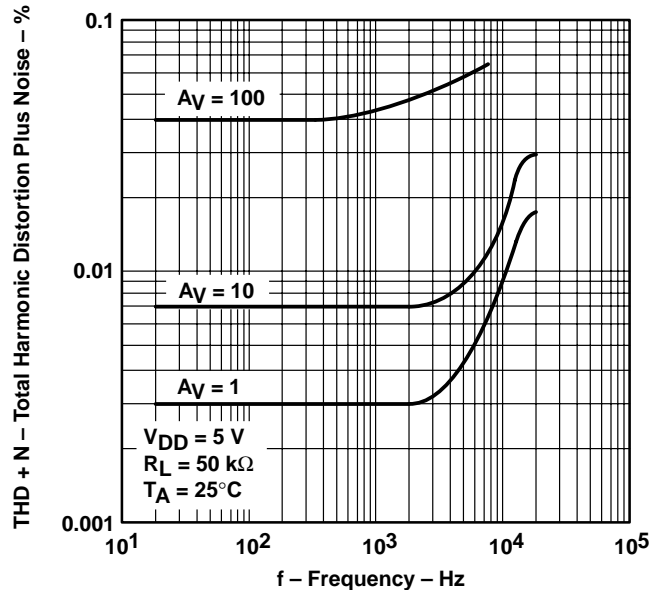

Figure 55

† For curves where  $V_{DD} = 5\text{ V}$ , all loads are referenced to 2.5 V.

TYPICAL CHARACTERISTICS

GAIN-BANDWIDTH PRODUCT  
vs  
SUPPLY VOLTAGE



Figure 56

GAIN-BANDWIDTH PRODUCT†‡  
vs  
FREE-AIR TEMPERATURE



Figure 57

PHASE MARGIN  
vs  
LOAD CAPACITANCE



Figure 58

GAIN MARGIN  
vs  
LOAD CAPACITANCE



Figure 59

† Data at high and low temperatures are applicable only within the rated operating free-air temperature ranges of the various devices.

‡ For curves where  $V_{DD} = 5$  V, all loads are referenced to 2.5 V.

**TYPICAL CHARACTERISTICS**



**Figure 60**



**Figure 61**

† See application information

## APPLICATION INFORMATION

### driving large capacitive loads

The TLC226x is designed to drive larger capacitive loads than most CMOS operational amplifiers. Figure 58 and Figure 59 illustrate its ability to drive loads greater than 400 pF while maintaining good gain and phase margins ( $R_{\text{null}} = 0$ ).

A smaller series resistor ( $R_{\text{null}}$ ) at the output of the device (see Figure 62) improves the gain and phase margins when driving large capacitive loads. Figure 58 and Figure 59 show the effects of adding series resistances of 10  $\Omega$ , 20  $\Omega$ , 50  $\Omega$ , and 100  $\Omega$ . The addition of this series resistor has two effects: the first is that it adds a zero to the transfer function and the second is that it reduces the frequency of the pole associated with the output load in the transfer function.

The zero introduced to the transfer function is equal to the series resistance times the load capacitance. To calculate the improvement in phase margin, equation 1 can be used.

$$\Delta\theta_{m1} = \tan^{-1} \left( 2 \times \pi \times \text{UGBW} \times R_{\text{null}} \times C_L \right) \quad (1)$$

Where :

- $\Delta\theta_{m1}$  = improvement in phase margin
- UGBW = unity-gain bandwidth frequency
- $R_{\text{null}}$  = output series resistance
- $C_L$  = load capacitance

The unity-gain bandwidth (UGBW) frequency decreases as the capacitive load increases (see Figure 60). To use equation 1, UGBW must be approximated from Figure 60.

Using equation 1 alone overestimates the improvement in phase margin, as illustrated in Figure 61. The overestimation is caused by the decrease in the frequency of the pole associated with the load, thus providing additional phase shift and reducing the overall improvement in phase margin. The pole associated with the load is reduced by the factor calculated in equation 2.

$$F = \frac{1}{1 + g_m \times R_{\text{null}}} \quad (2)$$

Where :

- F = factor reducing frequency of pole
- $g_m$  = small-signal output transconductance (typically  $4.83 \times 10^{-3}$  mhos)
- $R_{\text{null}}$  = output series resistance

For the TLC226x, the pole associated with the load is typically 7 MHz with 100-pF load capacitance. This value varies inversely with  $C_L$ : at  $C_L = 10$  pF, use 70 MHz, at  $C_L = 1000$  pF, use 700 kHz, and so on.

Reducing the pole associated with the load introduces phase shift, thereby reducing phase margin. This results in an error in the increase in phase margin expected by considering the zero alone (equation 1). Equation 3 approximates the reduction in phase margin due to the movement of the pole associated with the load. The result of this equation can be subtracted from the result of the equation in equation 1 to better approximate the improvement in phase margin.

**APPLICATION INFORMATION**

**driving large capacitive loads (continued)**

$$\Delta\theta_{m2} = \tan^{-1} \left[ \frac{UGBW}{(F \times P_2)} \right] - \tan^{-1} \left( \frac{UGBW}{P_2} \right) \tag{3}$$

Where :

$\Delta\theta_{m2}$  = reduction in phase margin

UGBW = unity-gain bandwidth frequency

F = factor from equation 2

$P_2$  = unadjusted pole (70 MHz @10 pF, 7 MHz @100 pF, etc.)

Using these equations with Figure 60 and Figure 61 enables the designer to choose the appropriate output series resistance to optimize the design of circuits driving large capacitive loads.



**Figure 62. Series-Resistance Circuit**

APPLICATION INFORMATION

macromodel information

Macromodel information provided was derived using Microsim *Parts*™, the model generation software used with Microsim *PSpice*™. The Boyle macromodel (see Note 5) and subcircuit in Figure 63 are generated using the TLC226x typical electrical and operating characteristics at  $T_A = 25^\circ\text{C}$ . Using this information, output simulations of the following key parameters can be generated to a tolerance of 20% (in most cases):

- Maximum positive output voltage swing
- Maximum negative output voltage swing
- Slew rate
- Quiescent power dissipation
- Input bias current
- Open-loop voltage amplification
- Unity-gain frequency
- Common-mode rejection ratio
- Phase margin
- DC output resistance
- AC output resistance
- Short-circuit output current limit

NOTE 5: G. R. Boyle, B. M. Cohn, D. O. Pederson, and J. E. Solomon, "Macromodeling of Integrated Circuit Operational Amplifiers," *IEEE Journal of Solid-State Circuits*, SC-9, 353 (1974).



Figure 63. Boyle Macromodel and Subcircuit

*PSpice* and *Parts* are trademarks of MicroSim Corporation.

**PACKAGING INFORMATION**

| Orderable Device | Status<br>(1) | Package Type | Package<br>Drawing | Pins | Package<br>Qty | Eco Plan<br>(2)     | Lead finish/<br>Ball material<br>(6) | MSL Peak Temp<br>(3) | Op Temp (°C) | Device Marking<br>(4/5)                 | Samples                 |
|------------------|---------------|--------------|--------------------|------|----------------|---------------------|--------------------------------------|----------------------|--------------|---|-------------------------|
| 5962-9469201QHA  | ACTIVE        | CFP          | U                  | 10   | 25             | Non-RoHS<br>& Green | SNPB                                 | N / A for Pkg Type   | -55 to 125   | 9469201QHA<br>TLC2262M                  | <a href="#">Samples</a> |
| 5962-9469203QPA  | ACTIVE        | CDIP         | JG                 | 8    | 50             | Non-RoHS<br>& Green | SNPB                                 | N / A for Pkg Type   | -55 to 125   | 9469203QPA<br>TLC2262AM                 | <a href="#">Samples</a> |
| 5962-9469204Q2A  | ACTIVE        | LCCC         | FK                 | 20   | 55             | Non-RoHS<br>& Green | SNPB                                 | N / A for Pkg Type   | -55 to 125   | 5962-<br>9469204Q2A<br>TLC2264<br>AMFKB | <a href="#">Samples</a> |
| 5962-9469204QCA  | ACTIVE        | CDIP         | J                  | 14   | 25             | Non-RoHS<br>& Green | SNPB                                 | N / A for Pkg Type   | -55 to 125   | 5962-9469204QC<br>A<br>TLC2264AMJB      | <a href="#">Samples</a> |
| TLC2262AID       | ACTIVE        | SOIC         | D                  | 8    | 75             | RoHS & Green        | NIPDAU                               | Level-1-260C-UNLIM   | -40 to 125   | 2262AI                                  | <a href="#">Samples</a> |
| TLC2262AIDG4     | ACTIVE        | SOIC         | D                  | 8    | 75             | TBD                 | Call TI                              | Call TI              | -40 to 125   |   | <a href="#">Samples</a> |
| TLC2262AIDR      | ACTIVE        | SOIC         | D                  | 8    | 2500           | RoHS & Green        | NIPDAU                               | Level-1-260C-UNLIM   | -40 to 125   | 2262AI                                  | <a href="#">Samples</a> |
| TLC2262AIP       | ACTIVE        | PDIP         | P                  | 8    | 50             | RoHS & Green        | NIPDAU                               | N / A for Pkg Type   | -40 to 125   | TLC2262AI                               | <a href="#">Samples</a> |
| TLC2262AIPWR     | ACTIVE        | TSSOP        | PW                 | 8    | 2000           | RoHS & Green        | NIPDAU                               | Level-1-260C-UNLIM   | -40 to 125   | Y2262A                                  | <a href="#">Samples</a> |
| TLC2262AIPWRG4   | ACTIVE        | TSSOP        | PW                 | 8    | 2000           | TBD                 | Call TI                              | Call TI              | -40 to 125   |   | <a href="#">Samples</a> |
| TLC2262AMJG      | ACTIVE        | CDIP         | JG                 | 8    | 50             | Non-RoHS<br>& Green | SNPB                                 | N / A for Pkg Type   | -55 to 125   | TLC2262<br>AMJG                         | <a href="#">Samples</a> |
| TLC2262AMJGB     | ACTIVE        | CDIP         | JG                 | 8    | 50             | Non-RoHS<br>& Green | SNPB                                 | N / A for Pkg Type   | -55 to 125   | 9469203QPA<br>TLC2262AM                 | <a href="#">Samples</a> |
| TLC2262CD        | ACTIVE        | SOIC         | D                  | 8    | 75             | RoHS & Green        | NIPDAU                               | Level-1-260C-UNLIM   | 0 to 70      | 2262C                                   | <a href="#">Samples</a> |
| TLC2262CDR       | ACTIVE        | SOIC         | D                  | 8    | 2500           | RoHS & Green        | NIPDAU                               | Level-1-260C-UNLIM   | 0 to 70      | 2262C                                   | <a href="#">Samples</a> |
| TLC2262CP        | ACTIVE        | PDIP         | P                  | 8    | 50             | RoHS & Green        | NIPDAU                               | N / A for Pkg Type   | 0 to 70      | TLC2262CP                               | <a href="#">Samples</a> |
| TLC2262CPE4      | ACTIVE        | PDIP         | P                  | 8    | 50             | TBD                 | Call TI                              | Call TI              | 0 to 70      |   | <a href="#">Samples</a> |
| TLC2262CPW       | LIFEBUY       | TSSOP        | PW                 | 8    | 150            | RoHS & Green        | NIPDAU                               | Level-1-260C-UNLIM   | 0 to 70      | P2262                                   |                         |

| Orderable Device | Status<br>(1) | Package Type | Package Drawing | Pins | Package Qty | Eco Plan<br>(2)     | Lead finish/<br>Ball material<br>(6) | MSL Peak Temp<br>(3) | Op Temp (°C) | Device Marking<br>(4/5)                 | Samples                 |
|------------------|---------------|--------------|-----------------|------|-------------|---------------------|--------------------------------------|----------------------|--------------|---|-------------------------|
| TLC2262CPWR      | ACTIVE        | TSSOP        | PW              | 8    | 2000        | RoHS & Green        | NIPDAU                               | Level-1-260C-UNLIM   | 0 to 70      | P2262                                   | <a href="#">Samples</a> |
| TLC2262CPWRG4    | ACTIVE        | TSSOP        | PW              | 8    | 2000        | TBD                 | Call TI                              | Call TI              | 0 to 70      |   | <a href="#">Samples</a> |
| TLC2262ID        | ACTIVE        | SOIC         | D               | 8    | 75          | RoHS & Green        | NIPDAU                               | Level-1-260C-UNLIM   |              | 2262I                                   | <a href="#">Samples</a> |
| TLC2262IDG4      | ACTIVE        | SOIC         | D               | 8    | 75          | TBD                 | Call TI                              | Call TI              |              |   | <a href="#">Samples</a> |
| TLC2262IDR       | ACTIVE        | SOIC         | D               | 8    | 2500        | RoHS & Green        | NIPDAU                               | Level-1-260C-UNLIM   |              | 2262I                                   | <a href="#">Samples</a> |
| TLC2262IP        | ACTIVE        | PDIP         | P               | 8    | 50          | RoHS & Green        | NIPDAU                               | N / A for Pkg Type   |              | TLC2262IP                               | <a href="#">Samples</a> |
| TLC2262MUB       | ACTIVE        | CFP          | U               | 10   | 25          | Non-RoHS<br>& Green | SNPB                                 | N / A for Pkg Type   | -55 to 125   | 9469201QHA<br>TLC2262M                  | <a href="#">Samples</a> |
| TLC2262QDR       | ACTIVE        | SOIC         | D               | 8    | 2500        | RoHS & Green        | NIPDAU                               | Level-1-260C-UNLIM   | -40 to 125   | C2262Q                                  | <a href="#">Samples</a> |
| TLC2264AID       | ACTIVE        | SOIC         | D               | 14   | 50          | RoHS & Green        | NIPDAU                               | Level-1-260C-UNLIM   | -40 to 125   | 2264AI                                  | <a href="#">Samples</a> |
| TLC2264AIDG4     | ACTIVE        | SOIC         | D               | 14   | 50          | TBD                 | Call TI                              | Call TI              | -40 to 125   |   | <a href="#">Samples</a> |
| TLC2264AIDR      | ACTIVE        | SOIC         | D               | 14   | 2500        | RoHS & Green        | NIPDAU                               | Level-1-260C-UNLIM   | -40 to 125   | 2264AI                                  | <a href="#">Samples</a> |
| TLC2264AIN       | ACTIVE        | PDIP         | N               | 14   | 25          | RoHS & Green        | NIPDAU                               | N / A for Pkg Type   | -40 to 125   | TLC2264AIN                              | <a href="#">Samples</a> |
| TLC2264AIPWR     | ACTIVE        | TSSOP        | PW              | 14   | 2000        | RoHS & Green        | NIPDAU                               | Level-1-260C-UNLIM   | -40 to 125   | Y2264A                                  | <a href="#">Samples</a> |
| TLC2264AIPWRG4   | ACTIVE        | TSSOP        | PW              | 14   | 2000        | TBD                 | Call TI                              | Call TI              | -40 to 125   |   | <a href="#">Samples</a> |
| TLC2264AMFKB     | ACTIVE        | LCCC         | FK              | 20   | 55          | Non-RoHS<br>& Green | SNPB                                 | N / A for Pkg Type   | -55 to 125   | 5962-<br>9469204Q2A<br>TLC2264<br>AMFKB | <a href="#">Samples</a> |
| TLC2264AMJB      | ACTIVE        | CDIP         | J               | 14   | 25          | Non-RoHS<br>& Green | SNPB                                 | N / A for Pkg Type   | -55 to 125   | 5962-9469204QC<br>A<br>TLC2264AMJB      | <a href="#">Samples</a> |
| TLC2264AQD       | ACTIVE        | SOIC         | D               | 14   | 50          | RoHS & Green        | NIPDAU                               | Level-1-260C-UNLIM   | -40 to 125   | 2264AQ                                  | <a href="#">Samples</a> |
| TLC2264AQDRG4    | ACTIVE        | SOIC         | D               | 14   | 2500        | RoHS & Green        | NIPDAU                               | Level-1-260C-UNLIM   |              | PJ2264A                                 | <a href="#">Samples</a> |
| TLC2264CD        | ACTIVE        | SOIC         | D               | 14   | 50          | RoHS & Green        | NIPDAU                               | Level-1-260C-UNLIM   | 0 to 70      | TLC2264C                                | <a href="#">Samples</a> |

| Orderable Device | Status<br>(1) | Package Type | Package Drawing | Pins | Package Qty | Eco Plan<br>(2) | Lead finish/<br>Ball material<br>(6) | MSL Peak Temp<br>(3) | Op Temp (°C) | Device Marking<br>(4/5) | Samples                 |
|------------------|---------------|--------------|-----------------|------|-------------|-----------------|--------------------------------------|----------------------|--------------|-------------------------|-------------------------|
| TLC2264CDR       | ACTIVE        | SOIC         | D               | 14   | 2500        | RoHS & Green    | NIPDAU                               | Level-1-260C-UNLIM   | 0 to 70      | TLC2264C                | <a href="#">Samples</a> |
| TLC2264CN        | ACTIVE        | PDIP         | N               | 14   | 25          | RoHS & Green    | NIPDAU                               | N / A for Pkg Type   | 0 to 70      | TLC2264CN               | <a href="#">Samples</a> |
| TLC2264CPWR      | ACTIVE        | TSSOP        | PW              | 14   | 2000        | RoHS & Green    | NIPDAU                               | Level-1-260C-UNLIM   | 0 to 70      | P2264                   | <a href="#">Samples</a> |
| TLC2264ID        | ACTIVE        | SOIC         | D               | 14   | 50          | RoHS & Green    | NIPDAU                               | Level-1-260C-UNLIM   |              | TLC2264I                | <a href="#">Samples</a> |
| TLC2264IDR       | ACTIVE        | SOIC         | D               | 14   | 2500        | RoHS & Green    | NIPDAU                               | Level-1-260C-UNLIM   |              | TLC2264I                | <a href="#">Samples</a> |
| TLC2264IN        | ACTIVE        | PDIP         | N               | 14   | 25          | RoHS & Green    | NIPDAU                               | N / A for Pkg Type   |              | TLC2264IN               | <a href="#">Samples</a> |

(1) The marketing status values are defined as follows:

**ACTIVE:** Product device recommended for new designs.

**LIFEBUY:** TI has announced that the device will be discontinued, and a lifetime-buy period is in effect.

**NRND:** Not recommended for new designs. Device is in production to support existing customers, but TI does not recommend using this part in a new design.

**PREVIEW:** Device has been announced but is not in production. Samples may or may not be available.

**OBSOLETE:** TI has discontinued the production of the device.

(2) **RoHS:** TI defines "RoHS" to mean semiconductor products that are compliant with the current EU RoHS requirements for all 10 RoHS substances, including the requirement that RoHS substance do not exceed 0.1% by weight in homogeneous materials. Where designed to be soldered at high temperatures, "RoHS" products are suitable for use in specified lead-free processes. TI may reference these types of products as "Pb-Free".

**RoHS Exempt:** TI defines "RoHS Exempt" to mean products that contain lead but are compliant with EU RoHS pursuant to a specific EU RoHS exemption.

**Green:** TI defines "Green" to mean the content of Chlorine (Cl) and Bromine (Br) based flame retardants meet JS709B low halogen requirements of <=1000ppm threshold. Antimony trioxide based flame retardants must also meet the <=1000ppm threshold requirement.

(3) MSL, Peak Temp. - The Moisture Sensitivity Level rating according to the JEDEC industry standard classifications, and peak solder temperature.

(4) There may be additional marking, which relates to the logo, the lot trace code information, or the environmental category on the device.

(5) Multiple Device Markings will be inside parentheses. Only one Device Marking contained in parentheses and separated by a "~" will appear on a device. If a line is indented then it is a continuation of the previous line and the two combined represent the entire Device Marking for that device.

(6) Lead finish/Ball material - Orderable Devices may have multiple material finish options. Finish options are separated by a vertical ruled line. Lead finish/Ball material values may wrap to two lines if the finish value exceeds the maximum column width.

**Important Information and Disclaimer:**The information provided on this page represents TI's knowledge and belief as of the date that it is provided. TI bases its knowledge and belief on information provided by third parties, and makes no representation or warranty as to the accuracy of such information. Efforts are underway to better integrate information from third parties. TI has taken and continues to take reasonable steps to provide representative and accurate information but may not have conducted destructive testing or chemical analysis on incoming materials and chemicals. TI and TI suppliers consider certain information to be proprietary, and thus CAS numbers and other limited information may not be available for release.

In no event shall TI's liability arising out of such information exceed the total purchase price of the TI part(s) at issue in this document sold by TI to Customer on an annual basis.

**OTHER QUALIFIED VERSIONS OF TLC2262, TLC2262A, TLC2262AM, TLC2262M, TLC2264A, TLC2264AM :**

- Catalog : [TLC2262A](#), [TLC2262](#), [TLC2264A](#)
- Automotive : [TLC2264A-Q1](#), [TLC2264A-Q1](#)
- Military : [TLC2262M](#), [TLC2262AM](#), [TLC2264AM](#)

NOTE: Qualified Version Definitions:

- Catalog - TI's standard catalog product
- Automotive - Q100 devices qualified for high-reliability automotive applications targeting zero defects
- Military - QML certified for Military and Defense Applications

## TAPE AND REEL INFORMATION

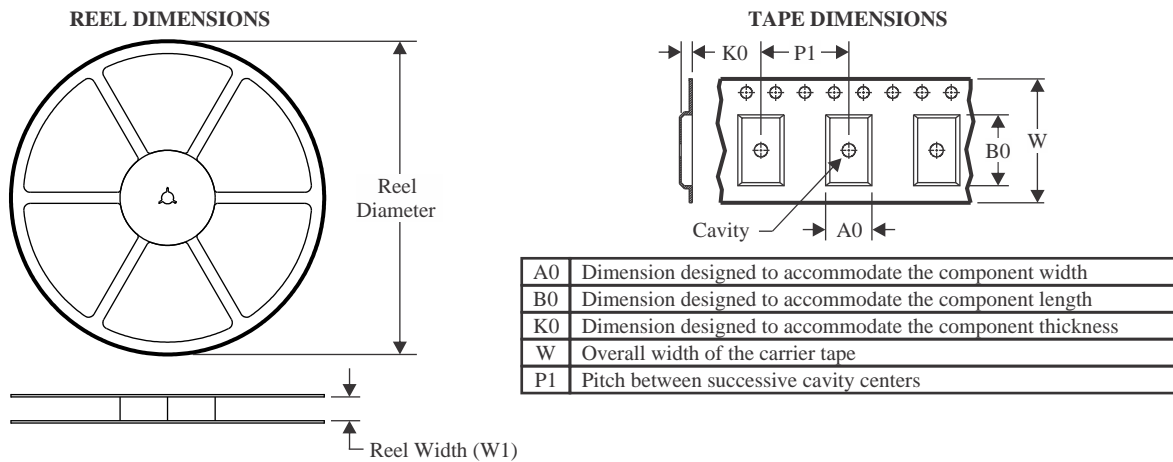

### QUADRANT ASSIGNMENTS FOR PIN 1 ORIENTATION IN TAPE

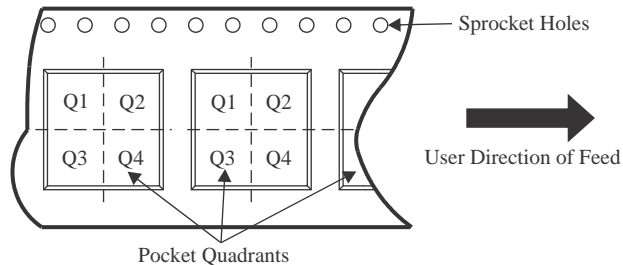

\*All dimensions are nominal

| Device        | Package Type | Package Drawing | Pins | SPQ  | Reel Diameter (mm) | Reel Width W1 (mm) | A0 (mm) | B0 (mm) | K0 (mm) | P1 (mm) | W (mm) | Pin1 Quadrant |
|---------------|--------------|-----------------|------|------|--------------------|--------------------|---------|---------|---------|---------|--------|---------------|
| TLC2262AIDR   | SOIC         | D               | 8    | 2500 | 330.0              | 12.4               | 6.4     | 5.2     | 2.1     | 8.0     | 12.0   | Q1            |
| TLC2262AIPWR  | TSSOP        | PW              | 8    | 2000 | 330.0              | 12.4               | 7.0     | 3.6     | 1.6     | 8.0     | 12.0   | Q1            |
| TLC2262CDR    | SOIC         | D               | 8    | 2500 | 330.0              | 12.4               | 6.4     | 5.2     | 2.1     | 8.0     | 12.0   | Q1            |
| TLC2262CPWR   | TSSOP        | PW              | 8    | 2000 | 330.0              | 12.4               | 7.0     | 3.6     | 1.6     | 8.0     | 12.0   | Q1            |
| TLC2262IDR    | SOIC         | D               | 8    | 2500 | 330.0              | 12.4               | 6.4     | 5.2     | 2.1     | 8.0     | 12.0   | Q1            |
| TLC2262QDR    | SOIC         | D               | 8    | 2500 | 330.0              | 12.5               | 6.4     | 5.2     | 2.1     | 8.0     | 12.0   | Q1            |
| TLC2264AIDR   | SOIC         | D               | 14   | 2500 | 330.0              | 16.4               | 6.5     | 9.0     | 2.1     | 8.0     | 16.0   | Q1            |
| TLC2264AIPWR  | TSSOP        | PW              | 14   | 2000 | 330.0              | 12.4               | 6.9     | 5.6     | 1.6     | 8.0     | 12.0   | Q1            |
| TLC2264AQDRG4 | SOIC         | D               | 14   | 2500 | 330.0              | 16.4               | 6.5     | 9.0     | 2.1     | 8.0     | 16.0   | Q1            |
| TLC2264AQDRG4 | SOIC         | D               | 14   | 2500 | 330.0              | 16.4               | 6.5     | 9.0     | 2.1     | 8.0     | 16.0   | Q1            |
| TLC2264CDR    | SOIC         | D               | 14   | 2500 | 330.0              | 16.4               | 6.5     | 9.0     | 2.1     | 8.0     | 16.0   | Q1            |
| TLC2264CPWR   | TSSOP        | PW              | 14   | 2000 | 330.0              | 12.4               | 6.9     | 5.6     | 1.6     | 8.0     | 12.0   | Q1            |
| TLC2264IDR    | SOIC         | D               | 14   | 2500 | 330.0              | 16.4               | 6.5     | 9.0     | 2.1     | 8.0     | 16.0   | Q1            |

## TAPE AND REEL BOX DIMENSIONS

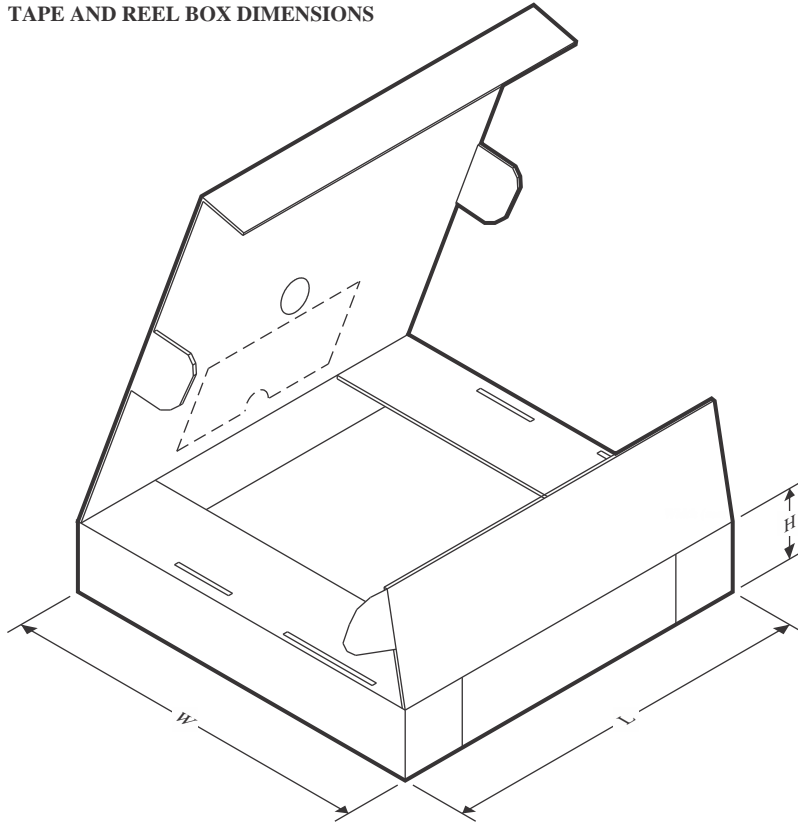

\*All dimensions are nominal

| Device        | Package Type | Package Drawing | Pins | SPQ  | Length (mm) | Width (mm) | Height (mm) |
|---------------|--------------|-----------------|------|------|-------------|------------|-------------|
| TLC2262AIDR   | SOIC         | D               | 8    | 2500 | 340.5       | 338.1      | 20.6        |
| TLC2262AIPWR  | TSSOP        | PW              | 8    | 2000 | 356.0       | 356.0      | 35.0        |
| TLC2262CDR    | SOIC         | D               | 8    | 2500 | 340.5       | 338.1      | 20.6        |
| TLC2262CPWR   | TSSOP        | PW              | 8    | 2000 | 356.0       | 356.0      | 35.0        |
| TLC2262IDR    | SOIC         | D               | 8    | 2500 | 340.5       | 338.1      | 20.6        |
| TLC2262QDR    | SOIC         | D               | 8    | 2500 | 340.5       | 338.1      | 20.6        |
| TLC2264AIDR   | SOIC         | D               | 14   | 2500 | 340.5       | 336.1      | 32.0        |
| TLC2264AIPWR  | TSSOP        | PW              | 14   | 2000 | 356.0       | 356.0      | 35.0        |
| TLC2264AQDRG4 | SOIC         | D               | 14   | 2500 | 340.5       | 336.1      | 32.0        |
| TLC2264AQDRG4 | SOIC         | D               | 14   | 2500 | 350.0       | 350.0      | 43.0        |
| TLC2264CDR    | SOIC         | D               | 14   | 2500 | 333.2       | 345.9      | 28.6        |
| TLC2264CPWR   | TSSOP        | PW              | 14   | 2000 | 356.0       | 356.0      | 35.0        |
| TLC2264IDR    | SOIC         | D               | 14   | 2500 | 340.5       | 336.1      | 32.0        |

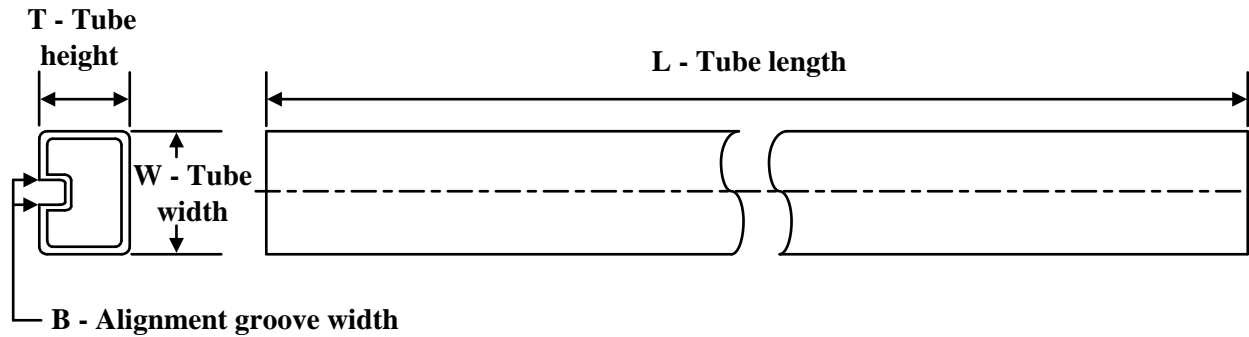
**TUBE**

\*All dimensions are nominal

| Device          | Package Name | Package Type | Pins | SPQ | L (mm) | W (mm) | T (μm) | B (mm) |
|-----------------|--------------|--------------|------|-----|--------|--------|--------|--------|
| 5962-9469201QHA | U            | CFP          | 10   | 25  | 506.98 | 26.16  | 6220   | NA     |
| 5962-9469204Q2A | FK           | LCCC         | 20   | 55  | 506.98 | 12.06  | 2030   | NA     |
| TLC2262AID      | D            | SOIC         | 8    | 75  | 505.46 | 6.76   | 3810   | 4      |
| TLC2262AID      | D            | SOIC         | 8    | 75  | 507    | 8      | 3940   | 4.32   |
| TLC2262AIP      | P            | PDIP         | 8    | 50  | 506    | 13.97  | 11230  | 4.32   |
| TLC2262CD       | D            | SOIC         | 8    | 75  | 507    | 8      | 3940   | 4.32   |
| TLC2262CP       | P            | PDIP         | 8    | 50  | 506    | 13.97  | 11230  | 4.32   |
| TLC2262CPW      | PW           | TSSOP        | 8    | 150 | 530    | 10.2   | 3600   | 3.5    |
| TLC2262ID       | D            | SOIC         | 8    | 75  | 507    | 8      | 3940   | 4.32   |
| TLC2262IP       | P            | PDIP         | 8    | 50  | 506    | 13.97  | 11230  | 4.32   |
| TLC2262MUB      | U            | CFP          | 10   | 25  | 506.98 | 26.16  | 6220   | NA     |
| TLC2264AID      | D            | SOIC         | 14   | 50  | 507    | 8      | 3940   | 4.32   |
| TLC2264AID      | D            | SOIC         | 14   | 50  | 505.46 | 6.76   | 3810   | 4      |
| TLC2264AIN      | N            | PDIP         | 14   | 25  | 506    | 13.97  | 11230  | 4.32   |
| TLC2264AMFKB    | FK           | LCCC         | 20   | 55  | 506.98 | 12.06  | 2030   | NA     |
| TLC2264AQD      | D            | SOIC         | 14   | 50  | 505.46 | 6.76   | 3810   | 4      |
| TLC2264AQD      | D            | SOIC         | 14   | 50  | 507    | 8      | 3940   | 4.32   |
| TLC2264CD       | D            | SOIC         | 14   | 50  | 505.46 | 6.76   | 3810   | 4      |
| TLC2264CD       | D            | SOIC         | 14   | 50  | 507    | 8      | 3940   | 4.32   |
| TLC2264CN       | N            | PDIP         | 14   | 25  | 506    | 13.97  | 11230  | 4.32   |
| TLC2264ID       | D            | SOIC         | 14   | 50  | 507    | 8      | 3940   | 4.32   |
| TLC2264IN       | N            | PDIP         | 14   | 25  | 506    | 13.97  | 11230  | 4.32   |

# PACKAGE OUTLINE

## JG0008A

### CDIP - 5.08 mm max height

CERAMIC DUAL IN-LINE PACKAGE



#### NOTES:

1. All linear dimensions are in millimeters. Any dimensions in parenthesis are for reference only. Dimensioning and tolerancing per ASME Y14.5M.
2. This drawing is subject to change without notice.
3. This package can be hermetically sealed with a ceramic lid using glass frit.
4. Index point is provided on cap for terminal identification.
5. Falls within MIL STD 1835 GDIP1-T8





## GENERIC PACKAGE VIEW

**FK 20**

**LCCC - 2.03 mm max height**

8.89 x 8.89, 1.27 mm pitch

LEADLESS CERAMIC CHIP CARRIER

This image is a representation of the package family, actual package may vary.  
Refer to the product data sheet for package details.

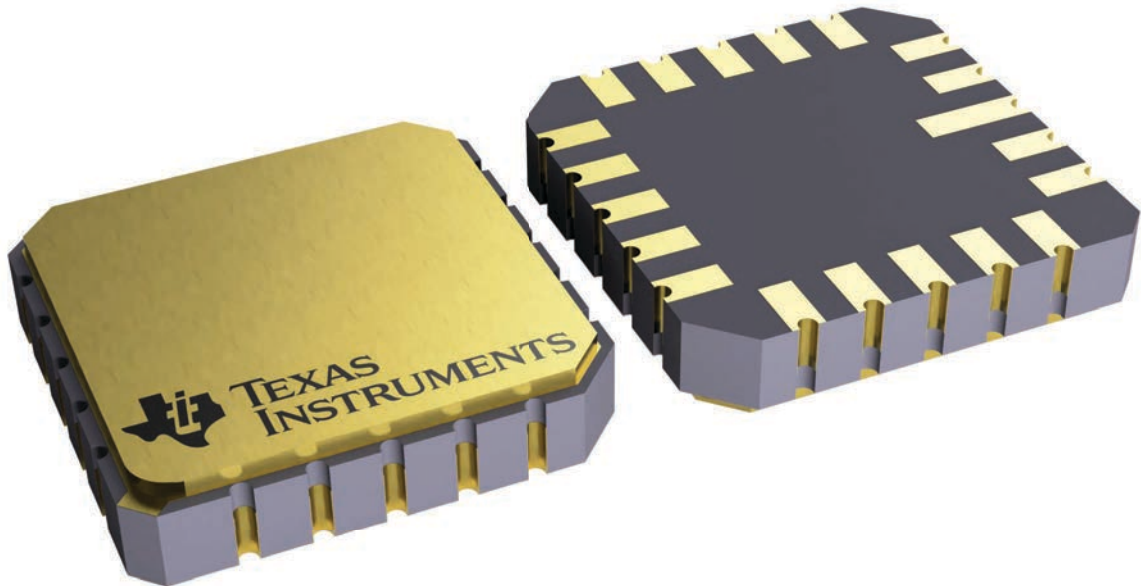

4229370VA\

J 14

**GENERIC PACKAGE VIEW**  
**CDIP - 5.08 mm max height**  
CERAMIC DUAL IN LINE PACKAGE

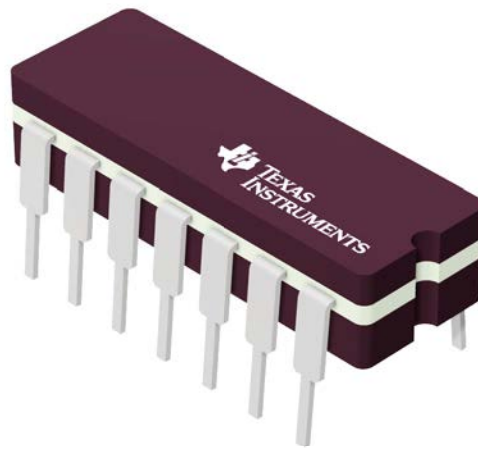

Images above are just a representation of the package family, actual package may vary.  
Refer to the product data sheet for package details.

4040083-5/G

J0014A

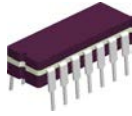

# PACKAGE OUTLINE

CDIP - 5.08 mm max height

CERAMIC DUAL IN LINE PACKAGE

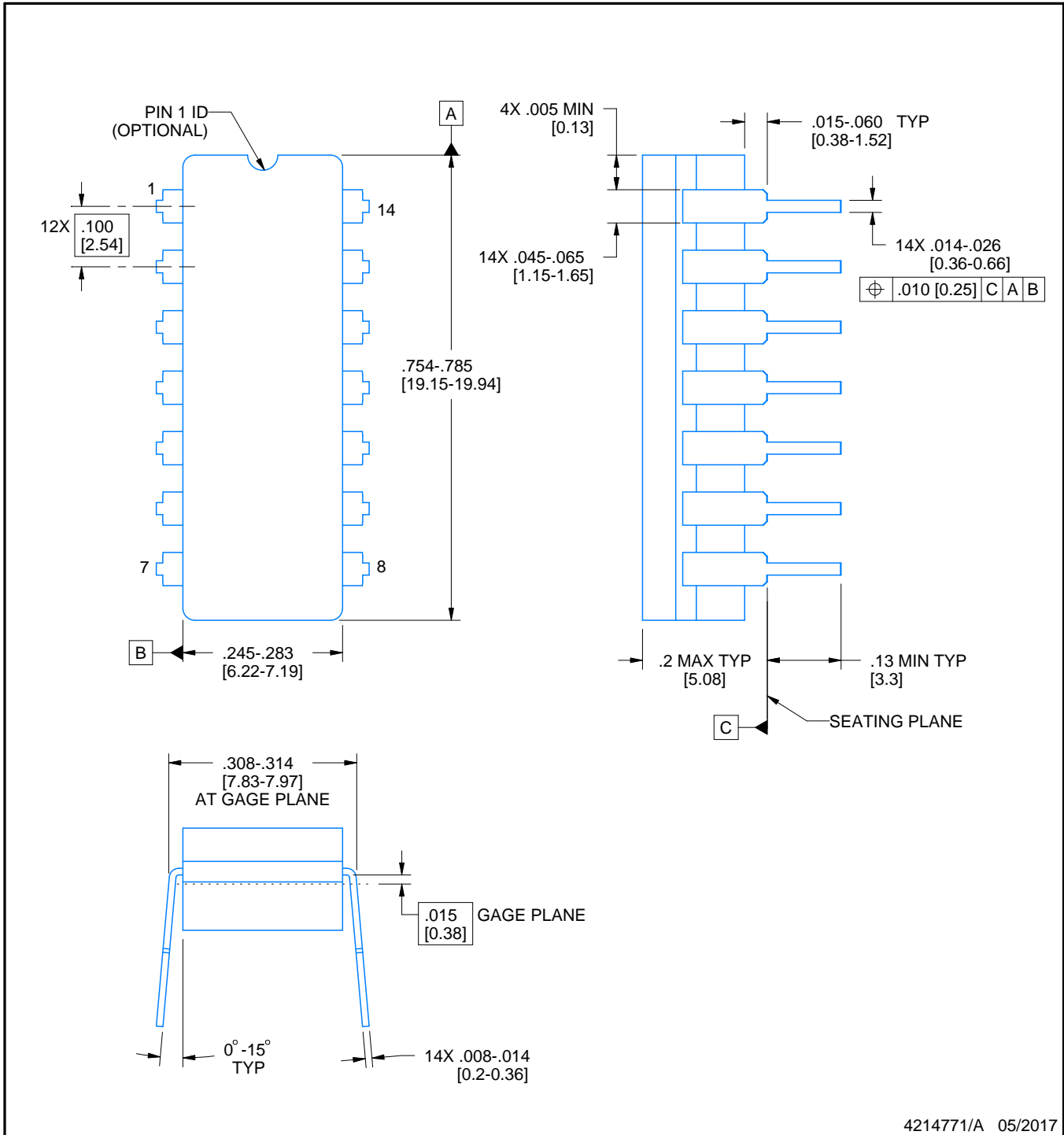

4214771/A 05/2017

NOTES:

1. All controlling linear dimensions are in inches. Dimensions in brackets are in millimeters. Any dimension in brackets or parenthesis are for reference only. Dimensioning and tolerancing per ASME Y14.5M.
2. This drawing is subject to change without notice.
3. This package is hermetically sealed with a ceramic lid using glass frit.
4. Index point is provided on cap for terminal identification only and on press ceramic glass frit seal only.
5. Falls within MIL-STD-1835 and GDIP1-T14.

# EXAMPLE BOARD LAYOUT

J0014A

CDIP - 5.08 mm max height

CERAMIC DUAL IN LINE PACKAGE

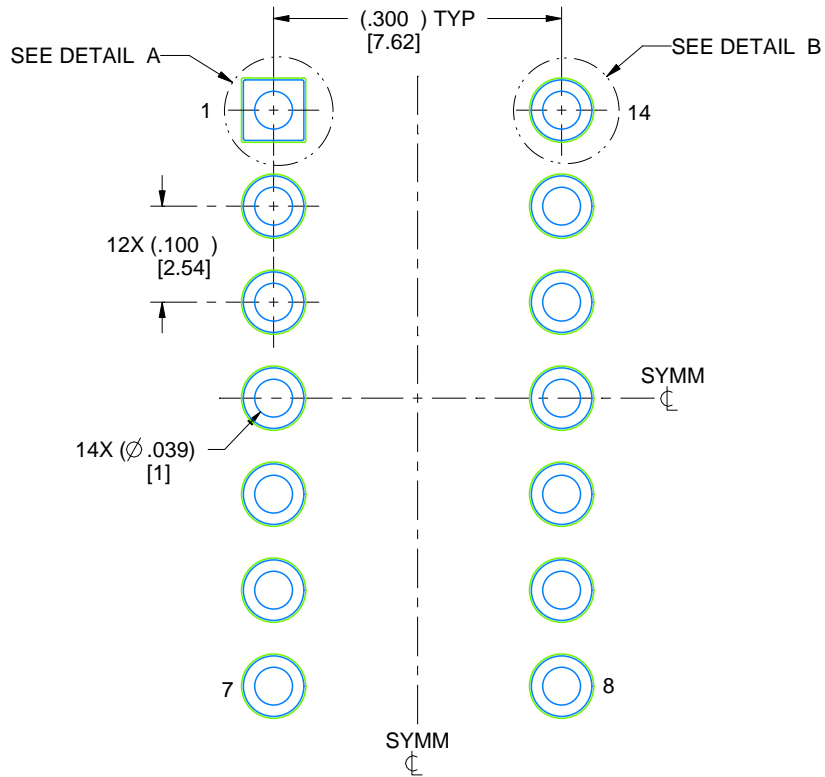

LAND PATTERN EXAMPLE  
NON-SOLDER MASK DEFINED  
SCALE: 5X

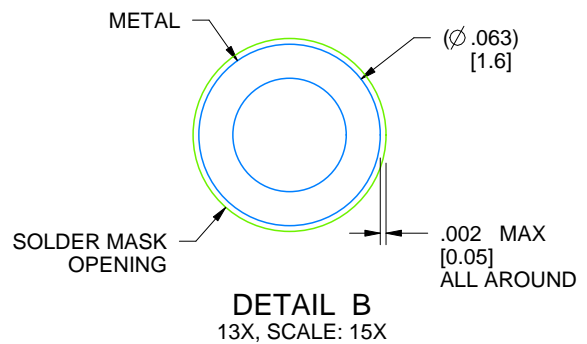
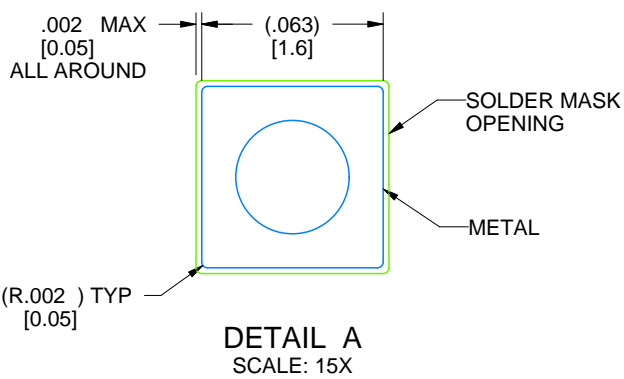

4214771/A 05/2017

D (R-PDSO-G14)

PLASTIC SMALL OUTLINE

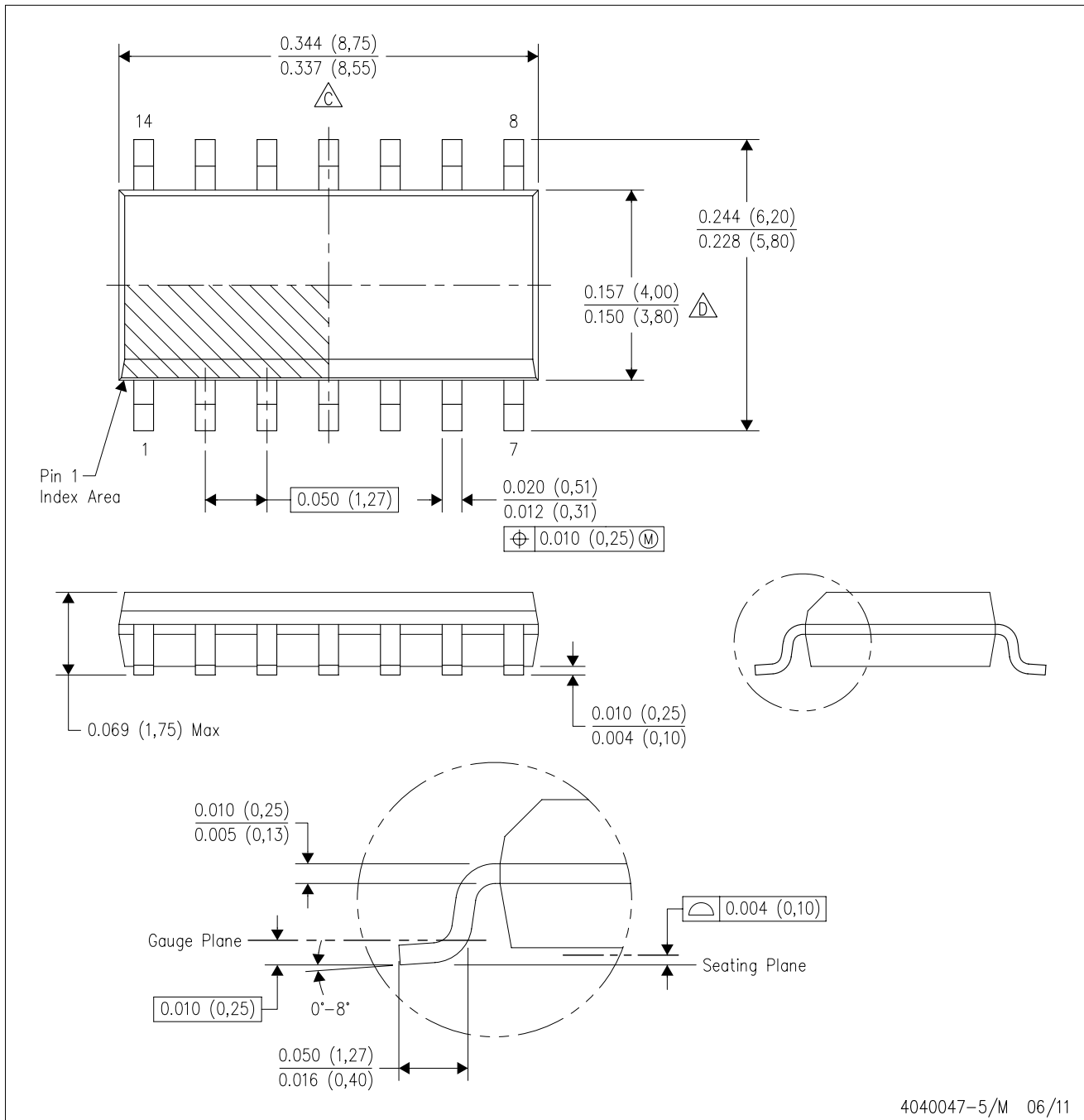

- NOTES:
- A. All linear dimensions are in inches (millimeters).
  - B. This drawing is subject to change without notice.
  - Body length does not include mold flash, protrusions, or gate burrs. Mold flash, protrusions, or gate burrs shall not exceed 0.006 (0,15) each side.
  - Body width does not include interlead flash. Interlead flash shall not exceed 0.017 (0,43) each side.
  - E. Reference JEDEC MS-012 variation AB.

D (R-PDSO-G14)

PLASTIC SMALL OUTLINE

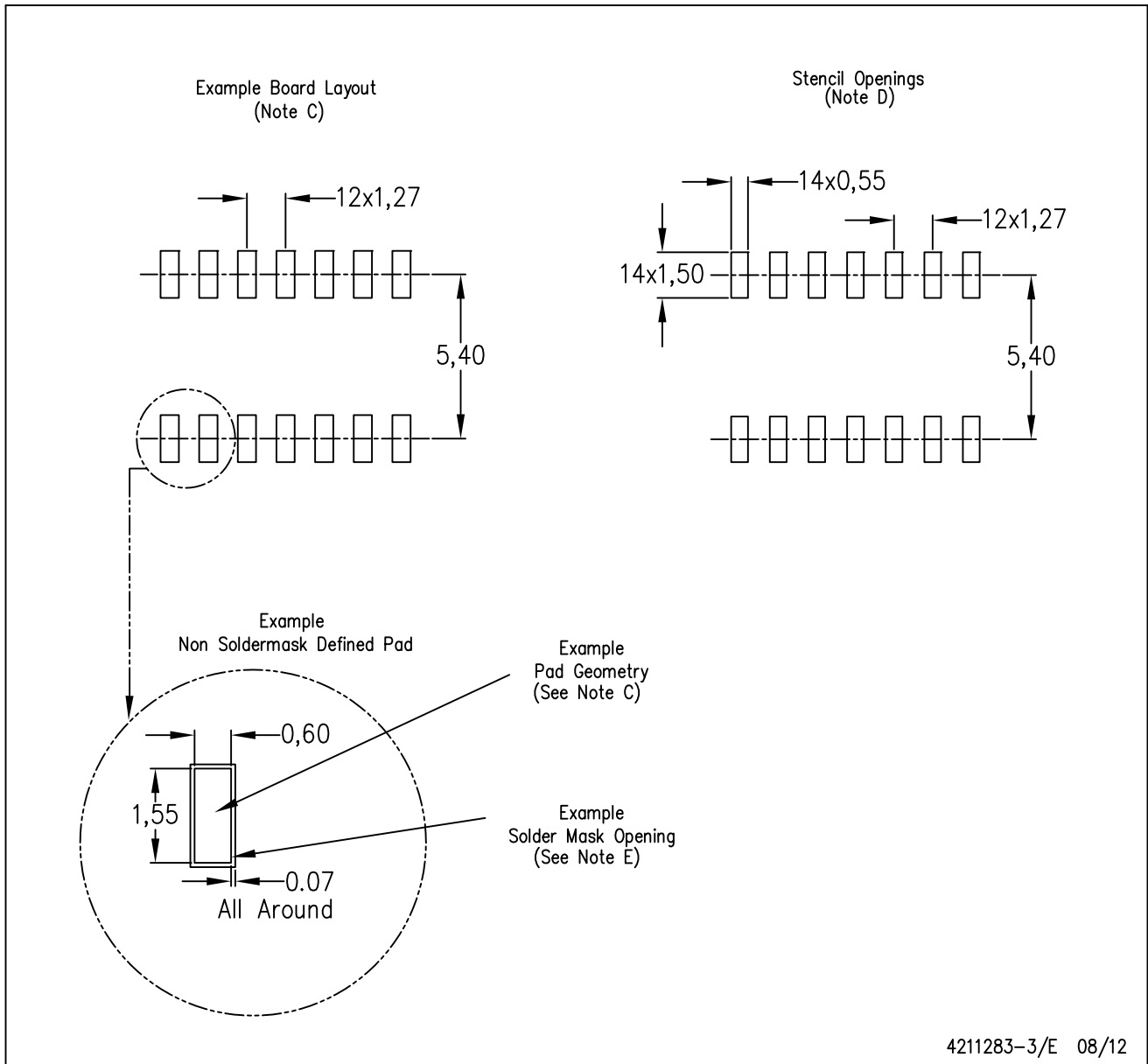

- NOTES:
- All linear dimensions are in millimeters.
  - This drawing is subject to change without notice.
  - Publication IPC-7351 is recommended for alternate designs.
  - Laser cutting apertures with trapezoidal walls and also rounding corners will offer better paste release. Customers should contact their board assembly site for stencil design recommendations. Refer to IPC-7525 for other stencil recommendations.
  - Customers should contact their board fabrication site for solder mask tolerances between and around signal pads.

PW (R-PDSO-G14)

PLASTIC SMALL OUTLINE

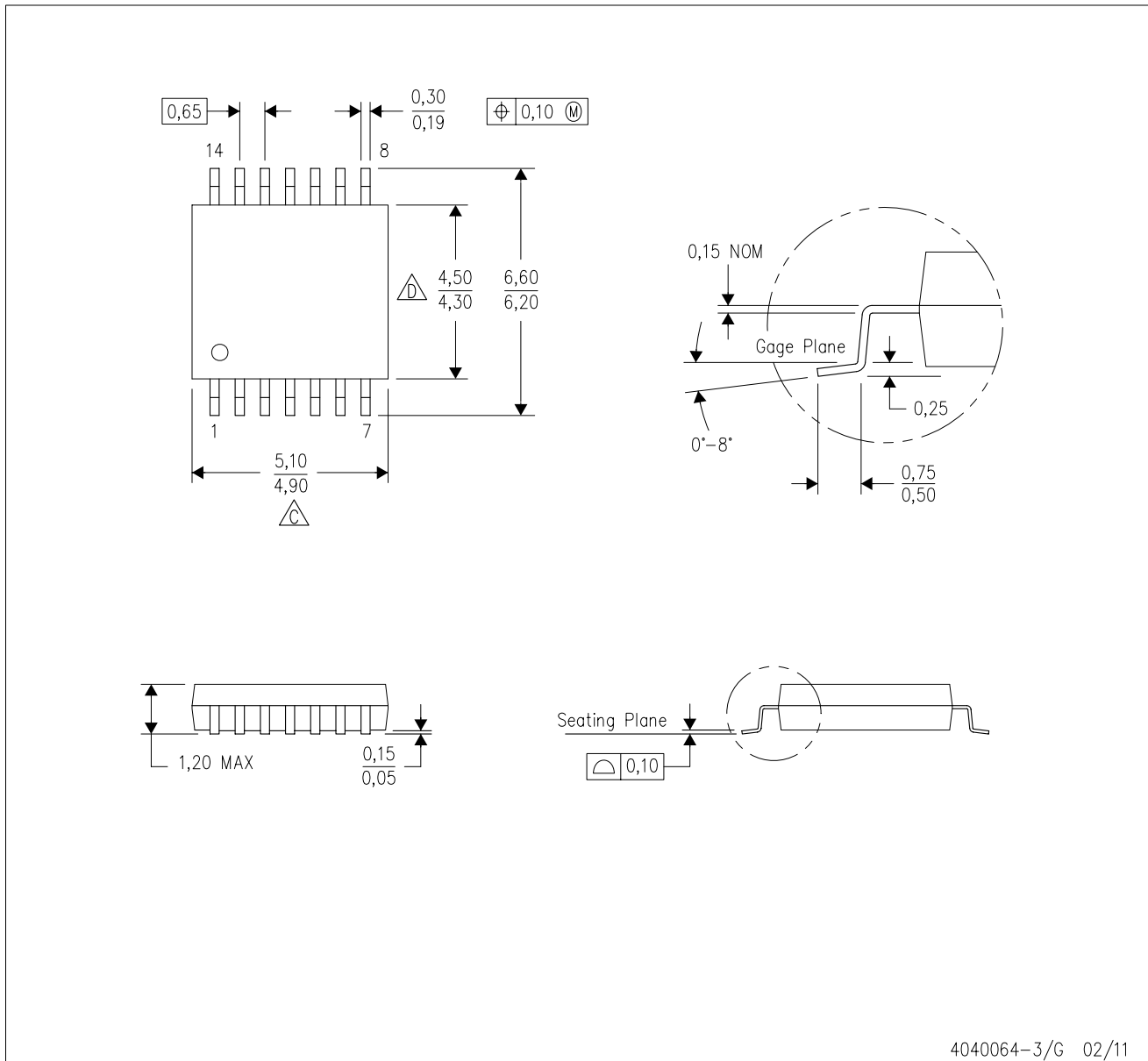

4040064-3/G 02/11

- NOTES:
- A. All linear dimensions are in millimeters. Dimensioning and tolerancing per ASME Y14.5M-1994.
  - B. This drawing is subject to change without notice.
  - C. Body length does not include mold flash, protrusions, or gate burrs. Mold flash, protrusions, or gate burrs shall not exceed 0,15 each side.
  - D. Body width does not include interlead flash. Interlead flash shall not exceed 0,25 each side.
  - E. Falls within JEDEC MO-153



D0008A

# PACKAGE OUTLINE

SOIC - 1.75 mm max height

SMALL OUTLINE INTEGRATED CIRCUIT



4214825/C 02/2019

### NOTES:

1. Linear dimensions are in inches [millimeters]. Dimensions in parenthesis are for reference only. Controlling dimensions are in inches. Dimensioning and tolerancing per ASME Y14.5M.
2. This drawing is subject to change without notice.
3. This dimension does not include mold flash, protrusions, or gate burrs. Mold flash, protrusions, or gate burrs shall not exceed  $.006$  [0.15] per side.
4. This dimension does not include interlead flash.
5. Reference JEDEC registration MS-012, variation AA.

# EXAMPLE BOARD LAYOUT

D0008A

SOIC - 1.75 mm max height

SMALL OUTLINE INTEGRATED CIRCUIT



LAND PATTERN EXAMPLE  
EXPOSED METAL SHOWN  
SCALE:8X



SOLDER MASK DETAILS

4214825/C 02/2019

NOTES: (continued)

- 6. Publication IPC-7351 may have alternate designs.
- 7. Solder mask tolerances between and around signal pads can vary based on board fabrication site.

# EXAMPLE STENCIL DESIGN

D0008A

SOIC - 1.75 mm max height

SMALL OUTLINE INTEGRATED CIRCUIT



SOLDER PASTE EXAMPLE  
BASED ON .005 INCH [0.125 MM] THICK STENCIL  
SCALE:8X

4214825/C 02/2019

NOTES: (continued)

8. Laser cutting apertures with trapezoidal walls and rounded corners may offer better paste release. IPC-7525 may have alternate design recommendations.
9. Board assembly site may have different recommendations for stencil design.

P (R-PDIP-T8)

PLASTIC DUAL-IN-LINE PACKAGE



- NOTES:
- A. All linear dimensions are in inches (millimeters).
  - B. This drawing is subject to change without notice.
  - C. Falls within JEDEC MS-001 variation BA.

N (R-PDIP-T\*\*)

PLASTIC DUAL-IN-LINE PACKAGE

16 PINS SHOWN



- NOTES:
- A. All linear dimensions are in inches (millimeters).
  - B. This drawing is subject to change without notice.
  - Falls within JEDEC MS-001, except 18 and 20 pin minimum body length (Dim A).
  - The 20 pin end lead shoulder width is a vendor option, either half or full width.



# EXAMPLE BOARD LAYOUT

PW0008A

TSSOP - 1.2 mm max height

SMALL OUTLINE PACKAGE



LAND PATTERN EXAMPLE  
SCALE:10X



SOLDER MASK DETAILS  
NOT TO SCALE

4221848/A 02/2015

NOTES: (continued)

- 6. Publication IPC-7351 may have alternate designs.
- 7. Solder mask tolerances between and around signal pads can vary based on board fabrication site.

# EXAMPLE STENCIL DESIGN

PW0008A

TSSOP - 1.2 mm max height

SMALL OUTLINE PACKAGE



SOLDER PASTE EXAMPLE  
BASED ON 0.125 mm THICK STENCIL  
SCALE:10X

4221848/A 02/2015

NOTES: (continued)

8. Laser cutting apertures with trapezoidal walls and rounded corners may offer better paste release. IPC-7525 may have alternate design recommendations.
9. Board assembly site may have different recommendations for stencil design.

## IMPORTANT NOTICE AND DISCLAIMER

TI PROVIDES TECHNICAL AND RELIABILITY DATA (INCLUDING DATA SHEETS), DESIGN RESOURCES (INCLUDING REFERENCE DESIGNS), APPLICATION OR OTHER DESIGN ADVICE, WEB TOOLS, SAFETY INFORMATION, AND OTHER RESOURCES "AS IS" AND WITH ALL FAULTS, AND DISCLAIMS ALL WARRANTIES, EXPRESS AND IMPLIED, INCLUDING WITHOUT LIMITATION ANY IMPLIED WARRANTIES OF MERCHANTABILITY, FITNESS FOR A PARTICULAR PURPOSE OR NON-INFRINGEMENT OF THIRD PARTY INTELLECTUAL PROPERTY RIGHTS.

These resources are intended for skilled developers designing with TI products. You are solely responsible for (1) selecting the appropriate TI products for your application, (2) designing, validating and testing your application, and (3) ensuring your application meets applicable standards, and any other safety, security, regulatory or other requirements.

These resources are subject to change without notice. TI grants you permission to use these resources only for development of an application that uses the TI products described in the resource. Other reproduction and display of these resources is prohibited. No license is granted to any other TI intellectual property right or to any third party intellectual property right. TI disclaims responsibility for, and you will fully indemnify TI and its representatives against, any claims, damages, costs, losses, and liabilities arising out of your use of these resources.

TI's products are provided subject to [TI's Terms of Sale](#) or other applicable terms available either on [ti.com](https://www.ti.com) or provided in conjunction with such TI products. TI's provision of these resources does not expand or otherwise alter TI's applicable warranties or warranty disclaimers for TI products.

TI objects to and rejects any additional or different terms you may have proposed.

Mailing Address: Texas Instruments, Post Office Box 655303, Dallas, Texas 75265  
Copyright © 2024, Texas Instruments Incorporated

## Looking for pricing, stock, or lifecycle information?

Click below to explore more details on WIN SOURCE:

 [View TLC2262QD on WIN SOURCE](#)

 [Texas Instruments](#) Information

## Optimize Your Supply Chain with WIN SOURCE Solutions

-  Global Sourcing Solution
-  Obsolete Management
-  Cost Control Management
-  Shortage Management
-  Alternative Solution
-  Excess Inventory Management