



**THE DATASHEET OF
DA14531MOD-00F01002**



General Description

The DA14531 SmartBond TINY™ Module is the first Dialog Semiconductor Bluetooth® Low Energy module based on world's lowest power DA14531 SoC.

The module offers a unique combination of the lowest power and the integration of all external components including antenna at a very affordable price.

The module is designed to enable the use of Bluetooth® Low Energy in applications where Bluetooth® Low Energy could not be used until now because of cost or complexity. The bigger picture is to drive Bluetooth® Low Energy technology into every application, turning every product into a connected IoT node to drive the next 1 billion IoT devices in the market.

The SmartBond TINY™ Module is supported by software that is easy to work with. This lowers the threshold to use Bluetooth® Low Energy technology and significantly speeds up the design time.

The module comes with a configurable DSPS (serial port service) and next generation Codeless software to design Bluetooth® applications without Bluetooth® knowledge or advanced programming skills.

The combination of an affordable price, the lowest power consumption and ease of use makes the DA14531 TINY™ Module an ideal product for the mass market, including the makers community.

Key Features

- Bluetooth®
 - Compatible with Bluetooth® v5.1, ETSI EN 300 328 and EN 300 440 Class 2 (Europe), FCC CFR47 Part 15 (US) and ARIB STD-T66 (Japan) core
 - Supports up to three connections
 - Renesas registered BD address preprogrammed in OTP
- Processing and memories
 - 16 MHz 32-bit Arm® Cortex® M0+ with SWD interface
 - 128 Kbytes internal FLASH
 - 48 Kbytes RAM
 - 144 Kbytes ROM
 - 32 Kbytes OTP
- Current Consumption
 - 2 mA RX at VBAT = 3 V
 - 4 mA TX at VBAT = 3 V and 0 dBm
 - 1.8 µA at sleep with all RAM retained
- Radio
 - Programmable RF transmit power from -19 to +2.2 dBm
 - -93 dBm receiver sensitivity
- Interfaces
 - Quadrature decoder with 3 channels
 - 3 channel 11-bit ENOB ADC
 - 2 general purpose timers with PWM
 - 9 GPIOs
 - SPI
 - 2x UART, 1-wire UART support
- I2C
- Power Management
 - Operating range (1.8 V - 3.6 V)
 - Inrush current control
- Other
 - Real Time Clock
 - Trimmed 32 MHz Crystal
- Packaging
 - 12.5 mm x 14.5 mm x 2.8 mm package
- Module Software Development Kit
 - Configurable DSPS
 - Codeless v2.0
 - SDK6 support
- Module Software Tools
 - Flash/OTP programmer
 - SUOTA support
 - Battery Life Estimation
 - Data Rate Monitoring
 - Real-Time Power Profiling
 - Production Line Testing
- Standards Conformance
 - BT SIG QDID 113959
 - Europe (CE/RED) and US (FCC)
 - Canada and Japan
 - South Korea and Taiwan
 - South Africa and Brazil
 - China and Thailand
 - India

Applications

- Beacons
- Remote Controls
- Proximity tags
- Low Power Sensors
- Commissioning/Provisioning
- RF pipe
- Toys
- Industrial applications
- Data acquisition
- Wellness
- Infotainment
- IoT
- Robotics
- Gaming

Contents

General Description	1
Key Features	1
Applications	2
Contents	3
Figures	4
Tables	4
1 References	5
2 Block Diagram	6
3 Pinout	7
4 Characteristics	10
4.1 Absolute Maximum Ratings	10
4.2 Recommended Operating Conditions.....	10
4.3 Device Characteristics	10
5 Mechanical Specifications	13
5.1 Dimensions	13
5.2 PCB Footprint.....	14
5.3 Marking	14
6 Packaging Information	15
6.1 Tape and Reel.....	15
6.2 Labeling.....	16
7 Application Information	16
8 Design Guidelines	17
8.1 Installation Location	17
8.2 Antenna Graphs	19
8.3 Radiation Pattern	20
9 Soldering	22
10 Ordering Information	23
11 Regulatory Information	23
11.1 CE (Radio Equipment Directive 2014/53/EU (RED)) - (Europe).....	24
11.2 FCC - (U.S.A.).....	25
11.3 IC (CANADA)	25
11.4 NCC (Taiwan)	26
11.5 MSIP (South Korea).....	27
11.6 Australia/New Zealand (RCM)	27
11.7 South Africa (ICASA)	27
11.8 Brazil (Anatel).....	27
11.9 China (SRRC)	28
11.10 MIC (JAPAN).....	28
11.11 Thailand (NBTC)	28
11.12 India (WPC).....	29
12 Environmental Information	30
13 Bluetooth® SIG Qualification	30

Revision History	31
------------------------	----

Figures

Figure 1: DA14531 SmartBond TINY™ Module Block Diagram	6
Figure 2: Pinout Diagram Top View	7
Figure 3: Mechanical Drawing	13
Figure 4: Module Footprint Top View	14
Figure 5: Module Shield Marking.....	14
Figure 6: Tape and Reel.....	15
Figure 7: Reel Labeling	16
Figure 8: Installation Locations for Optimum Antenna Performance	17
Figure 9: Antenna Performance in Proximity of Copper (Left), Laminate (Middle), and Laminate under Antenna (Right)	18
Figure 10: DA14531 TINY™ Module Evaluation Board	18
Figure 11: VSWR Installed in the Upper Left Corner (Position #1) of Evaluation Board	19
Figure 12: VSWR with Module Installed in Center (Position #2) of the Evaluation Board	19
Figure 13: VSWR with Module Installed in the Upper Right Corner (Position #3) of the Evaluation Board	19
Figure 14: Measurement Plane Definition	20
Figure 15: Radiation Pattern for XY-Plane, Horizontal Polarization.....	21
Figure 16: Radiation Pattern for XY-Plane, Vertical Polarization	21
Figure 17: Radiation Pattern for XZ-Plane, Horizontal Polarization	21
Figure 18: Radiation Pattern for XZ-Plane, Vertical Polarization	21
Figure 19: Radiation Pattern for YZ-Plane, Horizontal Polarization	21
Figure 20: Radiation Pattern for YZ-Plane, Vertical Polarization	21
Figure 21: Recommended Reflow Profile for Lead Free Solder	22

Tables

Table 1: Pin Description	7
Table 1: Absolute Maximum Ratings.....	10
Table 2: Recommended Operating Conditions	10
Table 3: DC Characteristics.....	10
Table 7: XTAL32MHz - Recommended Operating Conditions	12
Table 4: Digital IO - Recommended Operating Conditions	12
Table 5: Digital IO - DC Characteristics	12
Table 6: Radio 1Mbps - AC Characteristics	12
Table 9: Reel Specifications	15
Table 10: Antenna Efficiency vs TINY™ Module Positions.....	17
Table 11: Reflow Profile Specification.....	22
Table 12: MSL Level vs Floor Lifetime	23
Table 13: Ordering Information (Samples).....	23
Table 14: Ordering Information (Production).....	23
Table 15: Standards Conformance	24

1 References

- [1] DA14531, Datasheet.
- [2] DA14585/DA14531 SW Platform Reference Manual

2 Block Diagram

The SmartBond TINY™ Module is based on the Dialog Semiconductor DA14531 SoC configured in buck mode. With an integrated 1 Mbit flash, 32 MHz XTAL and a printed antenna, the module enables a faster time to market at reduced development costs.

The module, as seen in [Figure 1](#), is comprised of:

- 1 Mbit SPI FLASH
- 32 MHz XTAL
- 2 decoupling capacitors
- A power inductor
- A CLC filter and matching components for the printed antenna

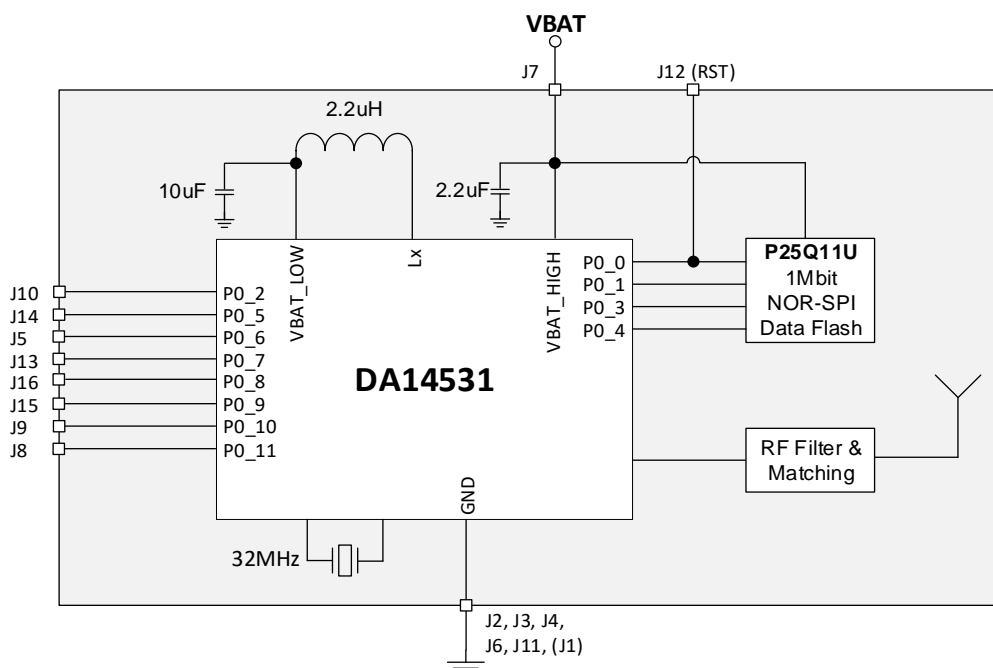

Figure 1: DA14531 SmartBond TINY™ Module Block Diagram

3 Pinout

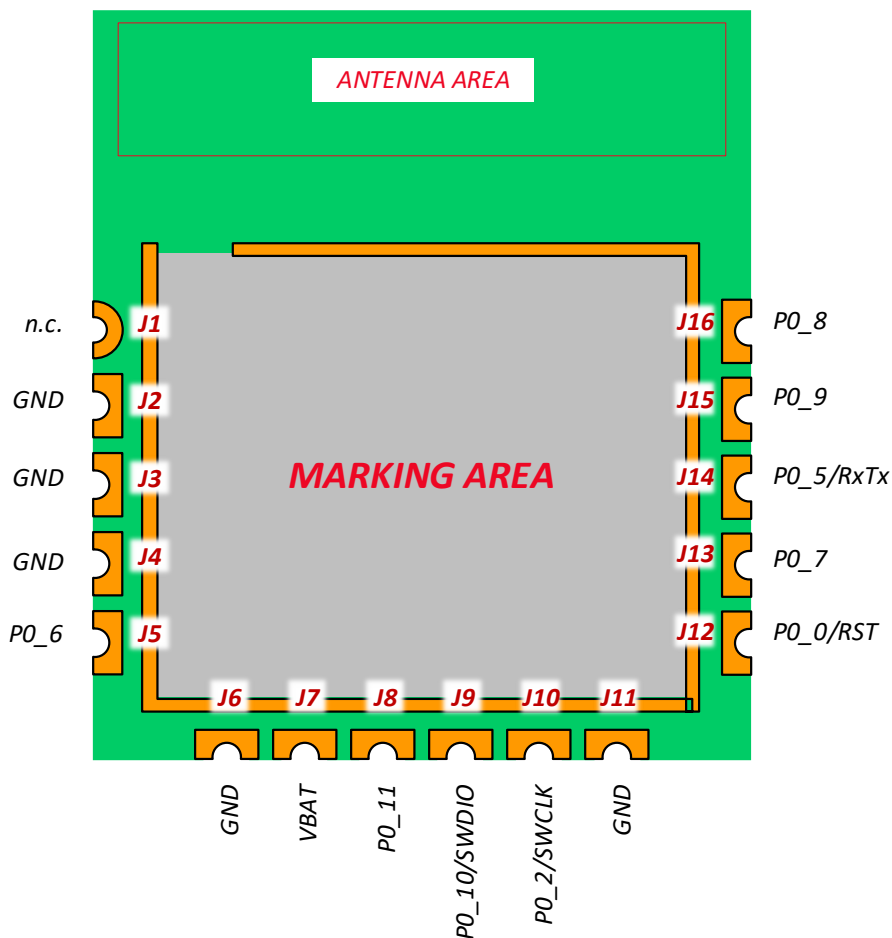

Figure 2: Pinout Diagram Top View

Note that J1 has no internal connection. J1 should be connected to ground.

Table 1: Pin Description

Pin #	Pin Name	Type	Reset State	Description
J1	n.c			Not internally connected. Recommended to be connected to ground externally
J2	GND	GND		Ground
J3	GND	GND		Ground
J4	GND	GND		Ground
J5	P0_6	DIO (Type A) Note 1	I-PD	INPUT/OUTPUT with selectable pull-up/down resistors. Pull-down enabled during and after reset. General purpose I/O port bit or alternate function nodes. Contains a state retention mechanism during power down
J6	GND	GND		Ground
J7	VBAT	PWR		POWER. Battery connection. IO supply

Pin #	Pin Name	Type	Reset State	Description
J8	P0_11	DIO (Type A)	I-PD	INPUT/OUTPUT with selectable pull-up/down resistors. Pull-down enabled during and after reset. General purpose I/O port bit or alternate function nodes. Contains a state retention mechanism during power down
J9	P0_10	DIO (Type A)	I-PD	INPUT/OUTPUT with selectable pull-up/down resistors. Pull-down enabled during and after reset. General purpose I/O port bit or alternate function nodes. Contains a state retention mechanism during power down
	SWDIO			INPUT/OUTPUT. SWI Data input/output. Bidirectional data and control communication (by default)
J10	P0_2	DIO (Type B)	I-PD	INPUT/OUTPUT with selectable pull-up/down resistors. Pull-down enabled during and after reset. General purpose I/O port bit or alternate function nodes. Contains a state retention mechanism during power-down
	SWCLK			INPUT SWI clock signal (by default)
J11	GND	GND		Ground
J12	P0_0	DIO (Type B) Note 2	I-PD	INPUT/OUTPUT with selectable pull-up/down resistors. Pull-down enabled during and after reset. General purpose I/O port bit or alternate function nodes. Contains a state retention mechanism during power-down
	RST			RST active high hardware reset (default)
J13	P0_7	DIO (Type A)	I-PD	INPUT/OUTPUT with selectable pull-up/down resistors. Pull-down enabled during and after reset. General purpose I/O port bit or alternate function nodes. Contains a state retention mechanism during power down
J14	P0_5	DIO (Type B)	I-PD	INPUT/OUTPUT with selectable pull-up/down resistors. Pull-down enabled during and after reset. General purpose I/O port bit or alternate function nodes. Contains a state retention mechanism during power down
J15	P0_9	DIO (Type A)	I-PD	INPUT/OUTPUT with selectable pull-up/down resistors. Pull-down enabled during and after reset. General purpose I/O port bit or alternate function nodes. Contains a state retention mechanism during power down
J16	P0_8	DIO (Type A)	I-PD	INPUT/OUTPUT with selectable pull-up/down resistors. Pull-down enabled during and after reset. General purpose I/O port bit or alternate function nodes. Contains a state retention mechanism during power down

Note 1 There are two types of pads, namely Type A and Type B. Type A is a normal IO pad with a Schmitt trigger on input while Type B has an extra RC Filter with a cutoff frequency of 100 kHz.

Note 2 This pin is also used for the communication to the internal SPI FLASH.

- I-PD is Input-Pulled Down
- I-PU is Input-Pulled Up
- DIO is Digital Input-Output
- PWR is power
- GND is Ground

4 Characteristics

All MIN/MAX specification limits are guaranteed by design, production testing, and/or statistical characterization. Typical values are based on characterization results at default measurement conditions and are informative only.

Default measurement conditions (unless otherwise specified): V_{BAT}= 3.0 V, T_A = 25 °C. All radio measurements are done with standard RF measurement equipment.

4.1 Absolute Maximum Ratings

Stresses beyond those listed under Absolute Maximum Ratings may cause permanent damage to the device. These are stress ratings only, so functional operation of the device at these or any other conditions beyond those indicated in the operational sections of the specification are not implied. Exposure to Absolute Maximum Rating conditions for extended periods may affect device reliability.

Table 2: Absolute Maximum Ratings

Parameter	Description	Conditions	Min	Max	Unit
V _{BAT_LIM}	Limiting battery supply voltage		-0.1	3.6	V

4.2 Recommended Operating Conditions

Table 3: Recommended Operating Conditions

Parameter	Description	Conditions	Min	Typ	Max	Unit
V _{BAT}	Battery supply voltage enabling FLASH programming		1.65		3.6	V
V _{PIN}	Voltage on a pin		-0.1		3.6	V
T _A	Ambient operating temperature		-40	25	85	°C

4.3 Device Characteristics

Table 4: DC Characteristics

Parameter	Description	Conditions	Min	Typ	Max	Unit
I _{BAT_ACTIVE}	Battery supply current with CPU running CoreMark from RAM at 16 MHz			0.4		mA
I _{BAT_BLE_ADV_100ms}	Average battery supply current with system in Advertising state (3 channels) every 100 ms and extended sleep with all RAM retained. TX output power at 2 dBm. FLASH is off.			80		μA

Parameter	Description	Conditions	Min	Typ	Max	Unit
I _{BAT_BLE_CON N_30ms}	Average battery supply current with system in a connection state with 30ms connection interval and extended sleep with all RAM retained. TX output power at 2 dBm. FLASH is off.			92		μA
I _{BAT_FLASH}	Battery supply current with CPU fetching code from serial FLASH. RF is off.			0.24		mA
I _{BAT_HIBERN}	Battery supply current with system shut down (Hibernation or shipping mode). FLASH is off.			0.6		μA
I _{BAT_IDLE}	Battery supply current with CPU in Wait for Interrupt Mode. FLASH is off.			0.23		mA
I _{BAT_SLP_20KB}	Battery supply current with system in extended sleep mode and 20 kB RAM retained			1.7		μA
I _{BAT_SLP_48KB}	Battery supply current with system in extended sleep mode and all RAM retained			2.1		μA
I _{BAT_RF_RX}	Battery supply current	Continuous RX; FLASH in sleep mode; DCDC converter is on;		2.3		mA
I _{BAT_RF_TX_+3 dBm}	Battery supply current	Continuous TX; FLASH in sleep mode; DCDC converter is on; Output power at 2.5 dBm; Note 1		4.3		mA
I _{BAT_RF_TX_0d Bm}	Battery supply current	Continuous TX; FLASH in sleep mode; DCDC converter is on; Output power at 0 dBm;		3.6		mA
I _{BAT_RF_TX_- 3dBm}	Battery supply current	Continuous TX; FLASH in sleep mode; DCDC converter is on; Output power at -3.5 dBm;		2.8		mA
I _{BAT_RF_TX_- 7dBm}	Battery supply current	Continuous TX; FLASH in sleep mode; DCDC converter is on; Output power at -7 dBm		2.3		mA
I _{BAT_RF_TX_- 19dBm}	Battery supply current	Continuous TX; FLASH in sleep mode; DCDC converter is on; Output power at -19.5 dBm		1.5		mA

Note 1 The actual TX output power is slightly different than the one indicated in the parameter name

Table 5: XTAL32MHz - Recommended Operating Conditions

Parameter	Description	Conditions	Min	Typ	Max	Unit
f _{XTAL_32M}	Crystal oscillator frequency			32		MHz
Δf _{XTAL}	Crystal frequency tolerance	After trimming; including aging and temperature drift	-25		25	ppm

Table 6: Digital IO - Recommended Operating Conditions

Parameter	Description	Conditions	Min	Typ	Max	Unit
V _{IH}	HIGH level input voltage		0.52			V
V _{IL}	LOW level input voltage				0.27	V

Table 7: Digital IO - DC Characteristics

Parameter	Description	Conditions	Min	Typ	Max	Unit
I _{IH}	HIGH level input current	V _I =V _{BAT_HIGH} = 3.0 V	-10		10	μA
I _{IL}	LOW level input current	V _I =V _{SS} = 0 V	-10		10	μA
I _{IH_PD}	HIGH level input current	V _I =V _{BAT} = 3.0 V	60		180	μA
I _{IL_PU}	LOW level input current	V _I =V _{SS} = 0 V, V _{BAT} = 3.0 V	-180		-60	μA
V _{OH}	HIGH level output voltage	I _O = 3.5 mA, V _{BAT} = 1.8 V	0.8*V _{BAT}			V
V _{OL}	LOW level output voltage	I _O = 3.5 mA, V _{BAT} = 1.8 V			0.2*V _{BAT}	V
V _{OH_LOWDRV}	HIGH level output voltage	I _O = 0.3 mA, V _{BAT} = 1.8 V	0.8*V _{BAT}			V
V _{OL_LOWDRV}	LOW level output voltage	I _O = 0.3 mA, V _{BAT} = 1.8 V			0.2*V _{BAT}	V

Table 8: Radio 1Mbps - AC Characteristics

Parameter	Description	Conditions	Min	Typ	Max	Unit
P _{SENS_CLEAN}	Sensitivity level	Dirty Transmitter disabled; DC-DC converter disabled; PER = 30.8 %; Note 1		-93		dBm
P _{SENS_EPKT}	Sensitivity level	Extended packet size (255 octets)		-91		dBm

Note 1 Measured according to Bluetooth® Low Energy Test Specification RF-PHY.TS/4.0.1, section 6.4.1.

5 Mechanical Specifications

5.1 Dimensions

The module's dimensions are shown in Figure 3.

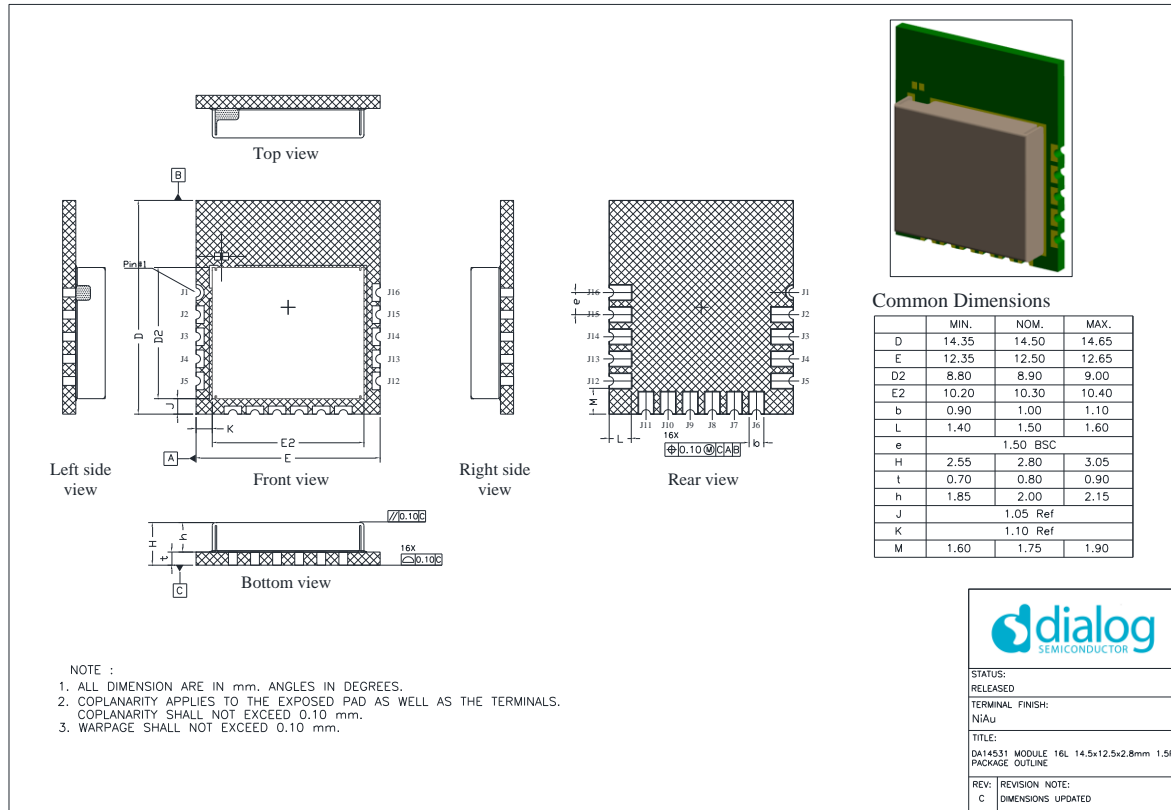

Figure 3: Mechanical Drawing

5.2 PCB Footprint

The footprint for the PCB is shown in [Figure 4](#).

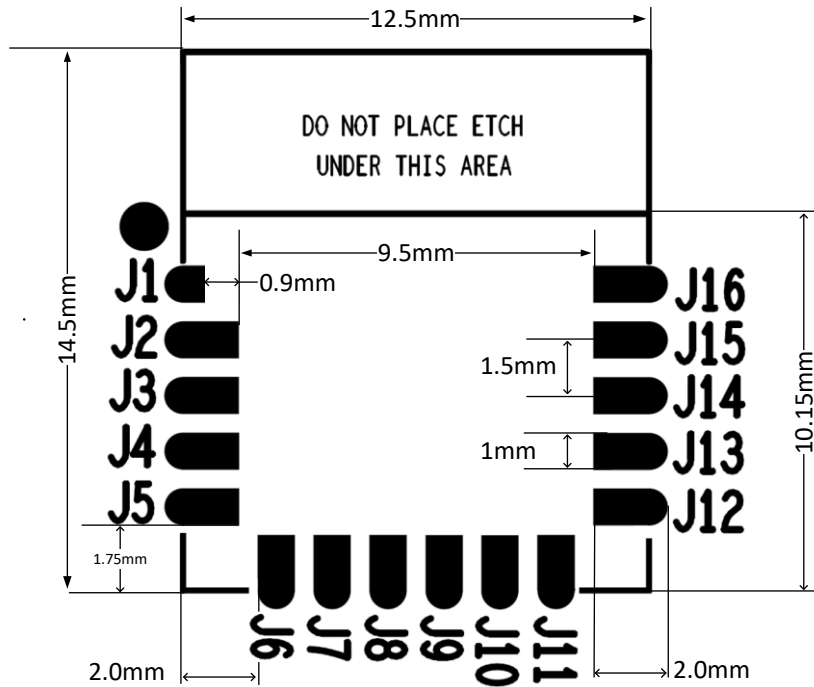

Figure 4: Module Footprint Top View

5.3 Marking

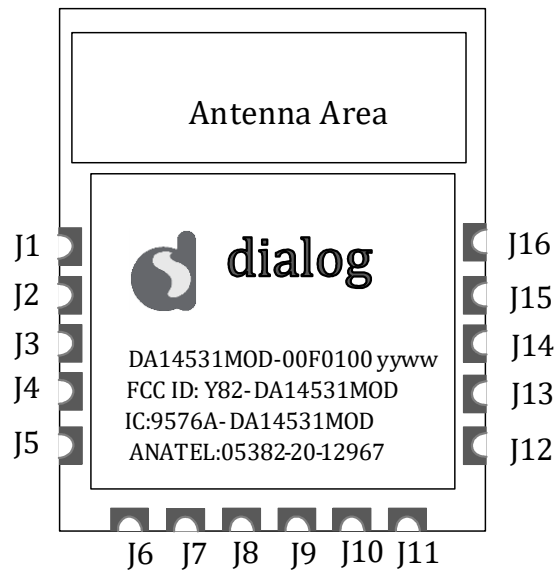

Figure 5: Module Shield Marking

6 Packaging Information

6.1 Tape and Reel

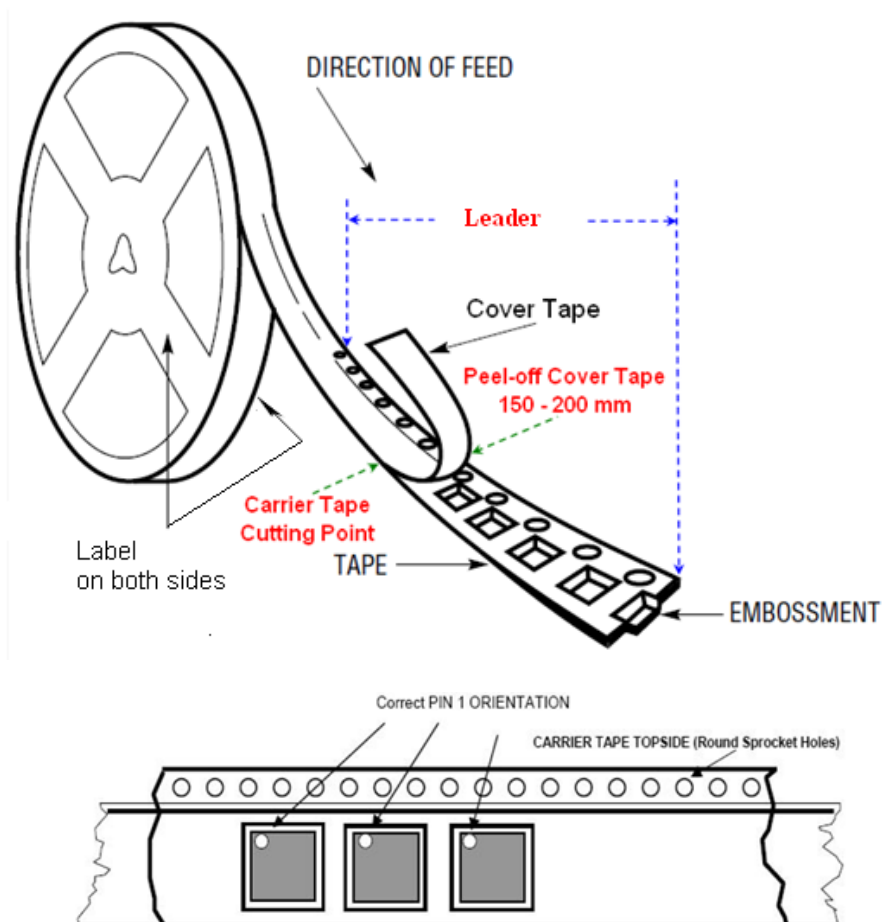

Figure 6: Tape and Reel

The actual reel specifications are presented in the following table:

Table 9: Reel Specifications

Diameter	13 inch
Reel tape width	24 mm
Tape material	Antistatic
Qty/Reel	100/1000 pcs
Leader	400 mm + 10%
Trailer	160 mm + 10%

6.2 Labeling

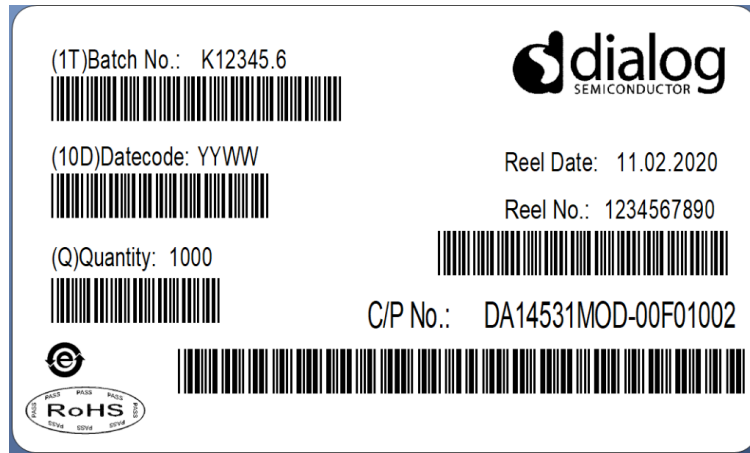

Figure 7: Reel Labeling

7 Application Information

There are some special considerations for the use of the TINY™ module, namely:

- The RST signal is shared with the MOSI input of the NOR flash. For this reason, RST must not be driven to GND. When the internal Flash is in use, the reset functionality is not available
- The SPI Bus of DA14531 is used for the communication of the SoC with the NOR Flash at boot time. Three of the four signals are not driven to external module pins. For this reason, a sensor that utilizes the SPI bus must be assigned (by software) to the module pins to communicate with after the boot is completed and when NOR Flash is no longer in use. An example is given in Figure 11

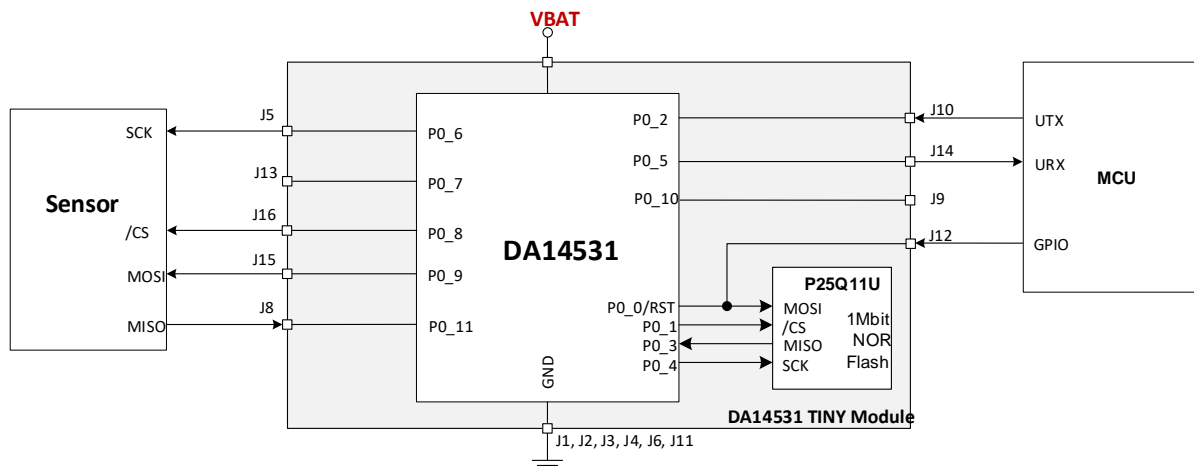

Figure 11: Example of Connecting a Sensor to the SPI Bus and an MCU to RST and UART

Note that the P0_0/RST pin (J12) should not be driven while the TINY™ module boots from its internal SPI FLASH.

8 Design Guidelines

The DA14531 SmartBond TINY™ Module comes with an integrated PCB trace antenna. The antenna area is 12x4 mm. The antenna's Voltage Standing Wave Ratio (VSWR) and efficiency depend on the installation location.

The radiation performance of the PCB trace antenna depends on the host PCB layout. The maximum antenna gain is -0.5 dBi when installed on a 50x50 mm reference board, as shown in Figure 19. The radiation pattern is omnidirectional. The RF front end is optimized to achieve the maximum possible efficiency for various installation positions of the module on a host PCB. To obtain a similar performance, follow the guidelines described in the following sections.

8.1 Installation Location

For optimum performance, install the module at the edge of a host PCB with the antenna edge facing out. The module can be located on either of the outer corners or the middle of the host PCB with equivalent performance.

The antenna should have 4 mm free space in all directions. Copper or laminate in the proximity of the antenna will affect the efficiency of the antenna. Laminate or copper under the antenna should be avoided as it severely affects the performance of the antenna. The antenna keep-out area can be seen in Figure 9.

Metals close to the antenna will degrade the antenna's performance. The amount of degradation depends on the host system's characteristics.

Table 10 summarizes the antenna efficiency at different installation locations on a host PCB as shown in Figure 8.

Table 10: Antenna Efficiency vs TINY™ Module Positions

Freq [MHz]	Position # 1 (Left)		Position # 2 (Middle)		Position # 3 (Right)	
	Antenna efficiency [%]	Antenna efficiency [dB]	Antenna efficiency [%]	Antenna efficiency [dB]	Antenna efficiency [%]	Antenna efficiency [dB]
2405	52	-2,8	40	-4,0	40	-4,0
2440	46	-3,4	34	-4,7	41	-3,9
2480	50	-3,0	40	-4,0	52	-2,8

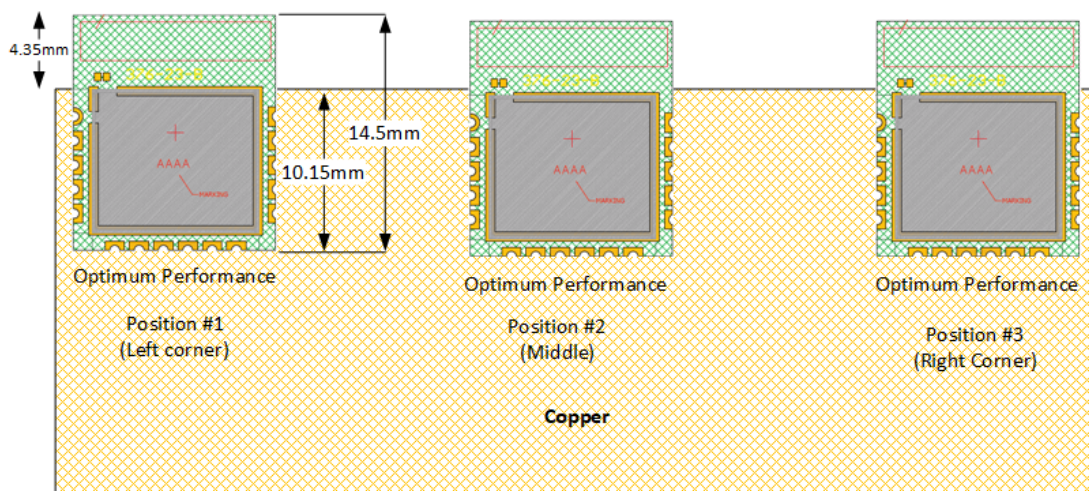

Figure 8: Installation Locations for Optimum Antenna Performance

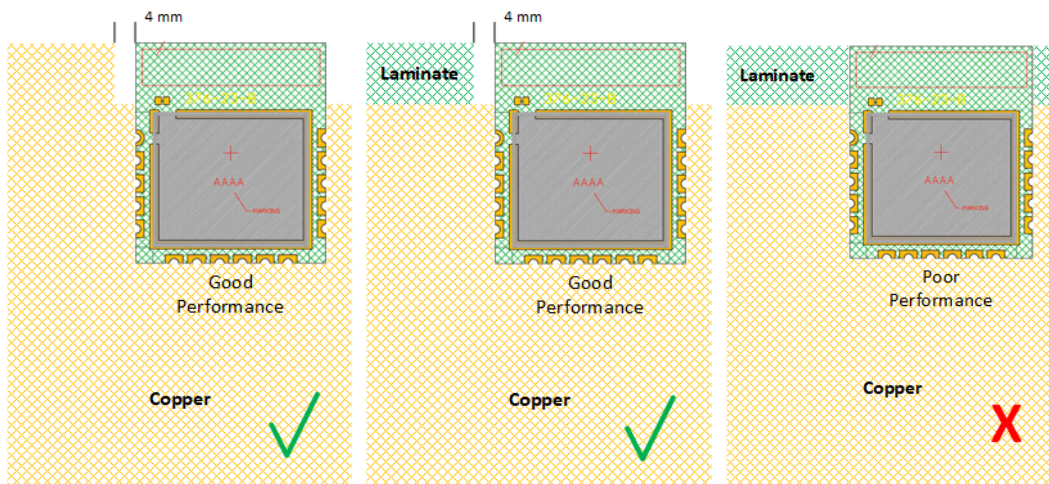

Figure 9: Antenna Performance in Proximity of Copper (Left), Laminate (Middle), and Laminate under Antenna (Right)

The actual TINY™ module evaluation board layout that has been used to conduct measurements is shown in Figure 10.

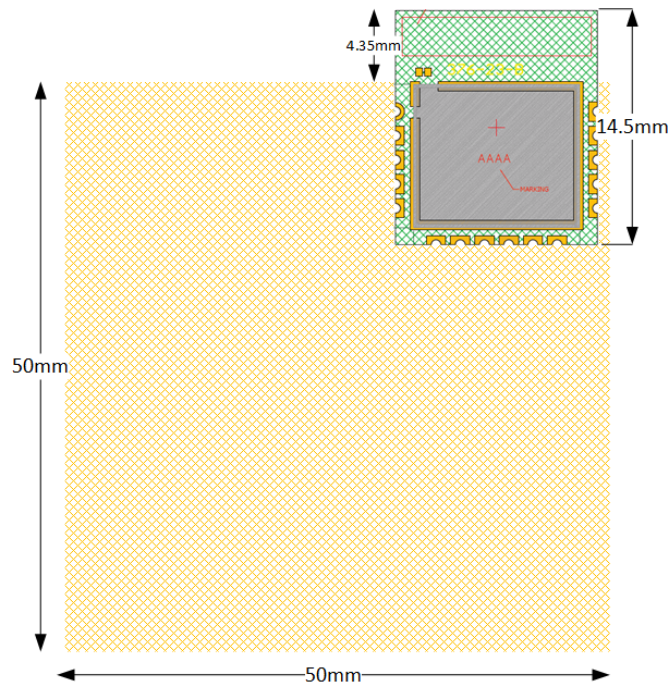

Figure 10: DA14531 TINY™ Module Evaluation Board

8.2 Antenna Graphs

The antenna VSWR measurements for the three installation positions are given in the following figures.

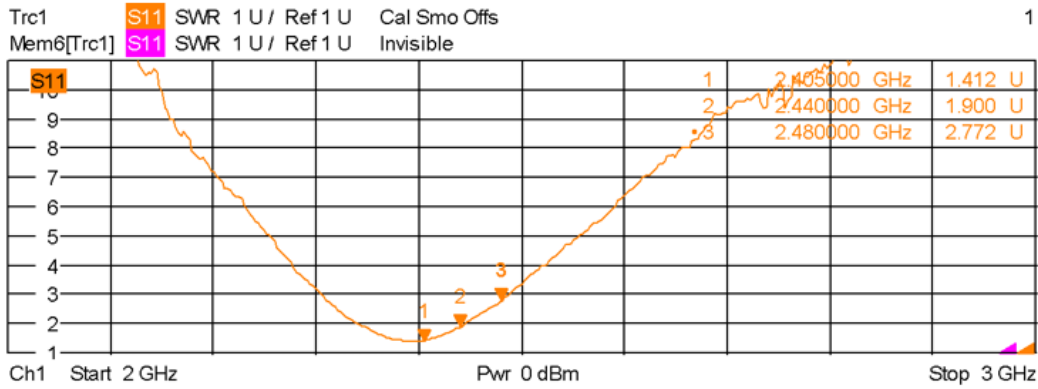

Figure 11: VSWR Installed in the Upper Left Corner (Position #1) of Evaluation Board

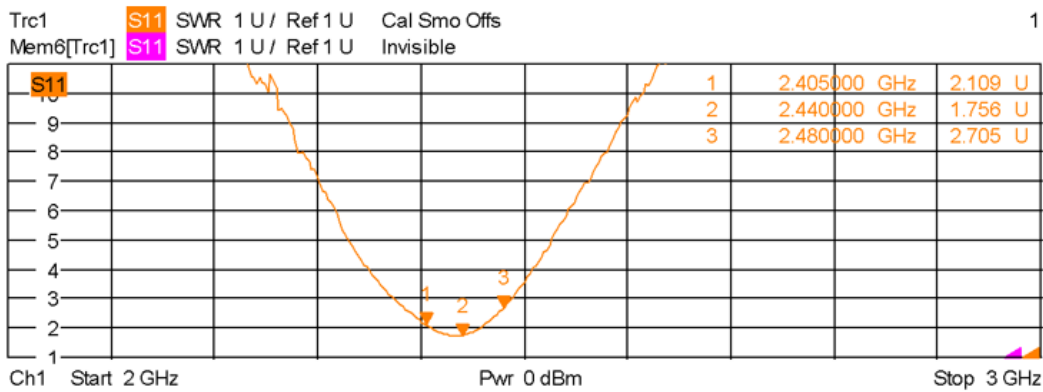

Figure 12: VSWR with Module Installed in Center (Position #2) of the Evaluation Board

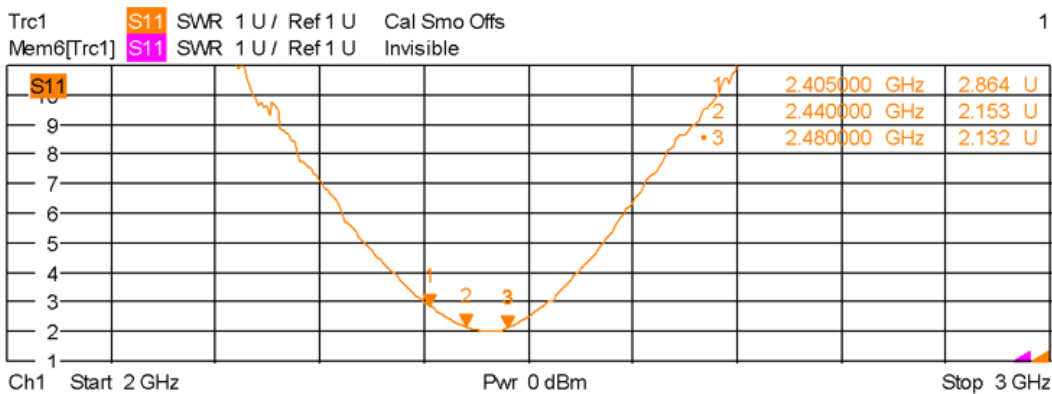

Figure 13: VSWR with Module Installed in the Upper Right Corner (Position #3) of the Evaluation Board

8.3 Radiation Pattern

The antenna radiation pattern measurements are carried out in an anechoic chamber. Radiation patterns are presented for three measurement planes: XY-, XZ-, and YZ- planes with horizontal and vertical polarization of the receiving antenna.

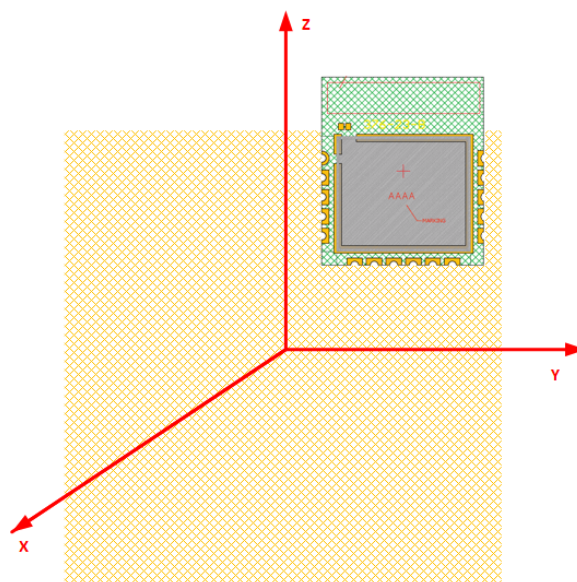

Figure 14: Measurement Plane Definition

Measurements are carried out for the module installed in the upper right corner on the reference board with no laminate below the antenna trace.

Radiation Pattern for Antenna Trace

Horizontal polarization

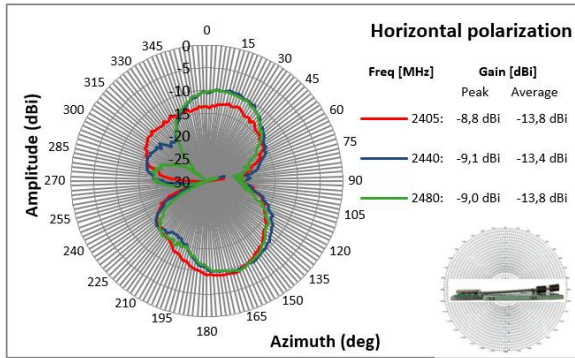

Figure 15: Radiation Pattern for XY-Plane, Horizontal Polarization

Vertical polarization

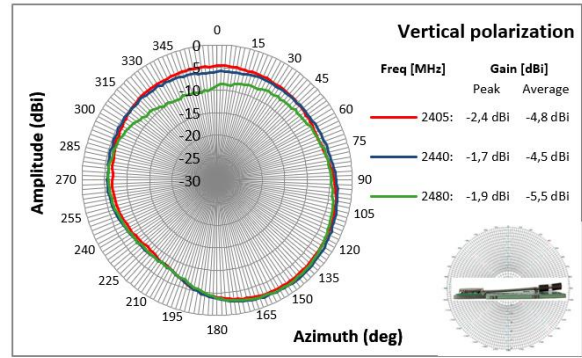

Figure 16: Radiation Pattern for XY-Plane, Vertical Polarization

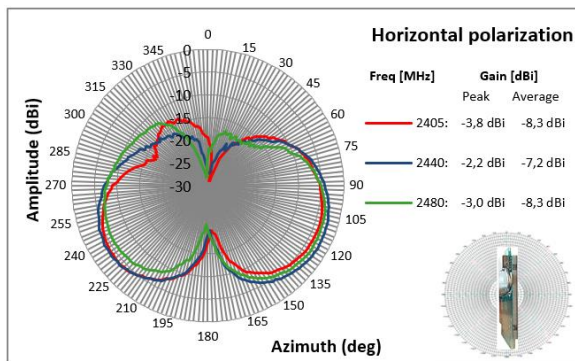

Figure 17: Radiation Pattern for XZ-Plane, Horizontal Polarization

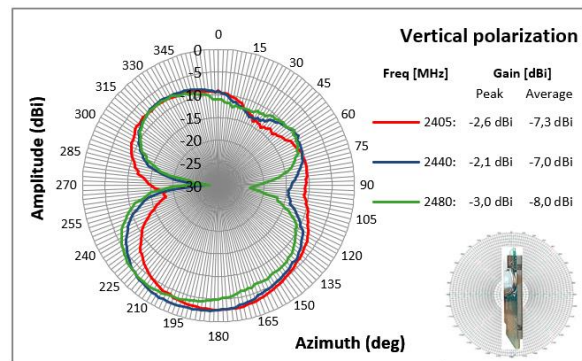

Figure 18: Radiation Pattern for XZ-Plane, Vertical Polarization

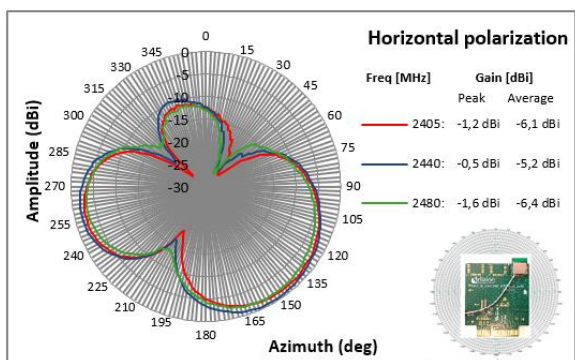

Figure 19: Radiation Pattern for YZ-Plane, Horizontal Polarization

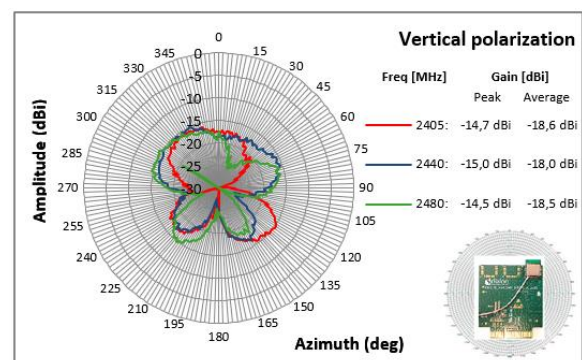

Figure 20: Radiation Pattern for YZ-Plane, Vertical Polarization

9 Soldering

The successful reflow soldering of the DA14531 TINY™ Module on a PCB depends on several parameters such as the thickness of the stencil, the pads solder paste aperture, the solder paste characteristics, the reflow soldering profile, size of the PCB, and so on.

The volume of solder paste applied to the board is mainly determined by the aperture size and stencil thickness. An initial solder paste aperture for the pads is provided on the solder paste layer of the PCB footprint. This aperture is modified by the assembly process experts according to stencil thickness, solder paste, and available assembly equipment.

The solder profile depends on the solder paste type used. For example, the soldering profile of a lead-free solder paste, Sn3Ag0.5Cu with no clean Flux (ROL0) and Solder Powder Type 4, is presented below.

No clean flux is recommended because washing must not be applied after assembly to avoid moisture being trapped under the shield.

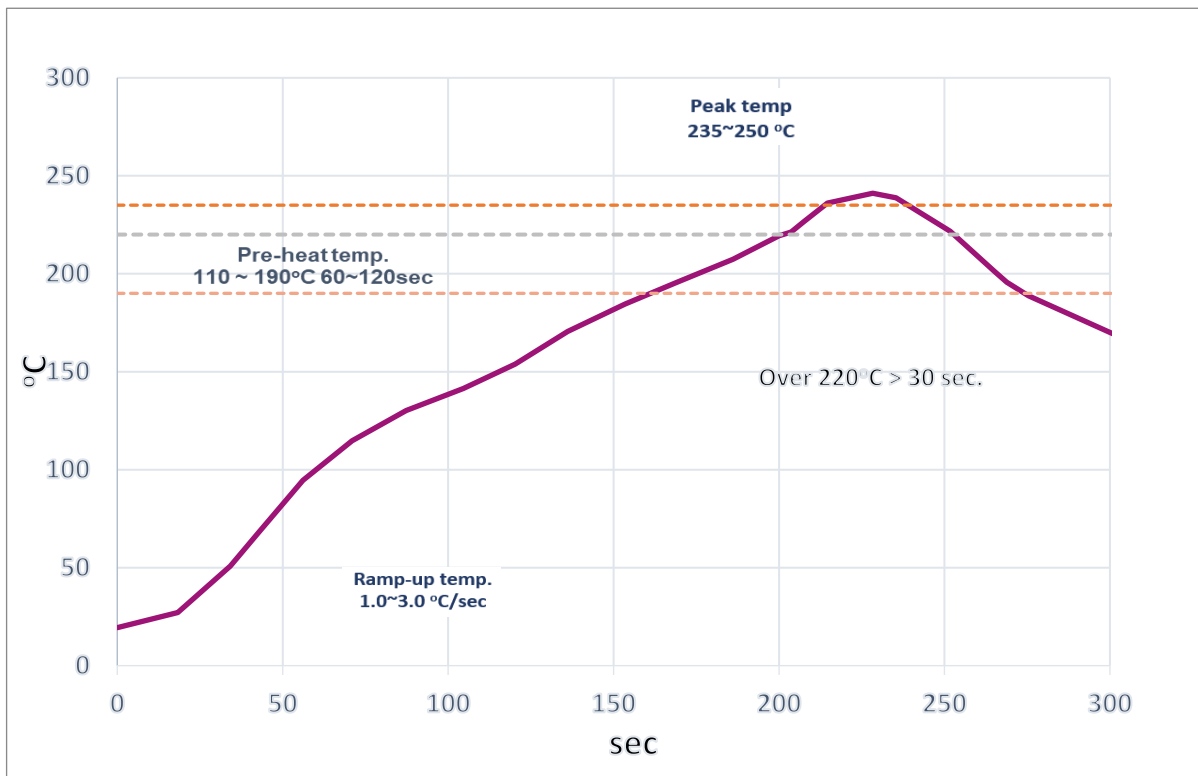

Figure 21: Recommended Reflow Profile for Lead Free Solder

Table 11: Reflow Profile Specification

Statistic Name	Low Limit	High Limit	Units
Slope1 (Target=2.0) Between 30.0 and 70.0	1	3	Degrees/Second
Slope2 (Target=2.0) Between 70.0 and 150.0	1	3	Degrees/Second
Slope3 (Target=-2.8) Between 220.0 and 150.0	-5	-0.5	Degrees/Second
Preheat time 110-190°C	60	120	Seconds
Time above reflow @220°C	30	65	Seconds
Peak temperature	235	250	Degrees Celsius
Total time above @235°C	10	30	Second

Solderability reflow check of five cycles was performed, applying the procedures mentioned in the JESD-A113E standard.

The MSL is an indicator for the maximum allowable time period (floor lifetime) in which a moisture-sensitive plastic device, once removed from the dry bag, can be exposed to an environment with a maximum temperature of 30 °C and a maximum relative humidity of 60 % RH before the solder reflow process.

DA14531 TINY Module is qualified for MSL 3.

Table 12: MSL Level vs Floor Lifetime

MSL Level	Floor Lifetime
MSL 4	72 hours
MSL 3	168 hours
MSL 2A	4 weeks
MSL 2	1 year
MSL 1	Unlimited at 30 °C/85 %RH

10 Ordering Information

The ordering number consists of the part number followed by a suffix that indicates the packing method. For details and availability, consult your Dialog Semiconductor [local sales representative](#).

Table 13: Ordering Information (Samples)

Part Number	Size (mm)	Shipment Form	Pack Quantity	MOQ
DA14531MOD-00F0100C	12.5 x 14.5 x 2.8	Reel	100	3

Table 14: Ordering Information (Production)

Part Number	Size (mm)	Shipment Form	Pack Quantity	MOQ
DA14531MOD-00F01002	12.5 x 14.5 x 2.8	Reel	1000	1

11 Regulatory Information

This section outlines the regulatory information for the DA14531 TINY™ Module. The module is certified for the global market. This facilitates the user end-product market entry. Please note that the end-product would need to apply for the end-product certification, however, the module certification listed below will facilitate that procedure.

When the end user sends the end product to those markets, the end product may need to follow additional requirements according to the specific market regulation.

For example, some markets have additional testing and/or certification like Korea EMC, South Africa SABS EMC and some have the requirement to put on the end-product label a modular approval ID or mark that consists of an approved Bluetooth® Low Energy modular ID on the host label directly, like Japan, Taiwan, Brazil.

A list of the Conformance Standards that DA14531 TINY™ Module meets is presented in [Table 15](#).

Table 15: Standards Conformance

Area	Item	Service	Standard	Certificate ID
Global	Safety for module	CB	IEC 62368-1:2014	SG ITS-21032 Note 1
Europe	Wireless	RED	EN 300 328 v2.2.2 EN 62479:2010	SE-RED-2001958 Ed.1
	Safety for module	CE	EN 62368-1	
	EMC	RED	EN 301 489-1 v2.1.1 EN 301 489 v3.1.1	
US/CA	Wireless	FCC ID	FCC PART 15 C:2017	Y82-DA14531MOD
		IC ID	RSS-247 Issue 2: February 2017 RSS-Gen Issue 4: November 2014	9576A-DA14531MOD
Japan	Wireless	MIC	JRL	018-200152
Taiwan	Wireless	NCC	LP0002	CCAG20LP0160T6
South Korea	Wireless	MSIP	방송통신표준 KS X 3123 "무선 설비 적합성 평가 시험 방법" KN 301 489	R-R-Dlg-DA14531MOD
South Africa	Wireless	ICASA	Based on RED	TA-2020/5882
Brazil	Wireless	Anatel	ATO No.14448/2017 Resolution No.680	05382-20-12967
China	Wireless	SRRC	信部无 【2002】353	2020DP5042
Thailand	Wireless	NBTC	NBTC TS 1035- 2562	RT 1768
India	Wireless	WPC	Based on RED	ETA-SD-20210402433

Note 1 Include national differences of US/Canada/Japan/China/Korea/Europe/Australia/South Africa/Taiwan/Brazil/Thailand.

11.1 CE (Radio Equipment Directive 2014/53/EU (RED)) - (Europe)

The DA14531 TINY™ Module is a Radio Equipment Directive (RED) assessed radio that is CE marked. The module has been manufactured and tested with the intention of being a sub assembly to a final product. The module has been tested to RED 2014/53/EU Essential Requirements for Health, Safety and Radio. The applicable standards are:

- Radio: EN 300 328 V2.2.2 (2019-07)
- Health: (SAR) EN 62479:2010
- Safety: EN 62368-1
- EMC: EN 301 489-1 v2.1.1, EN 301 489 v3.1.1

End-product will need to perform the radio EMC tests according to EN 301 489. The conducted tests can be inherited from the module test report. It is recommended to repeat the EN 300 328 radiated testing with the end-product assembly.

11.2 FCC - (U.S.A.)

FCC ID: Y82-DA14531MOD

This device complies with Part 15 of the FCC Rules. Operation is subject to the following two conditions: (1) this device may not cause harmful interference, and (2) this device must accept any interference received, including interference that may cause undesired operation.

Warning: Changes or modifications to this unit not expressly approved by the party responsible for compliance could void the user's authority to operate the equipment.

FCC RF Radiation Exposure Statement:

This device complies with FCC radiation exposure limits set forth for an uncontrolled environment and meets the FCC radio frequency (RF) Exposure Guidelines. This transmitter must not be co-located or operating in conjunction with any other antenna or transmitter.

OEM Responsibilities to comply with FCC Regulations:

OEM integrator is responsible for testing their end-product for any additional compliance requirements needed for the module installation like EMC testing according to FCC Part 15B.

Class B Device Notice

This equipment has been tested and found to comply with the limits for a Class B digital device, pursuant to part 15 of the FCC Rules. These limits are designed to provide reasonable protection against harmful interference in a residential installation. This equipment generates uses and can radiate radio frequency energy and, if not installed and used in accordance with the instructions, may cause harmful interference to radio communications. However, there is no guarantee that interference will not occur in a particular installation. If this equipment does cause harmful interference to radio or television reception, which can be determined by turning the equipment off and on, the user is encouraged to try to correct the interference by one or more of the following measures:

- Reorient or relocate the receiving antenna
- Increase the separation between the equipment and receiver
- Connect the equipment into an outlet on a circuit different from that to which the receiver is connected
- Consult the dealer or an experienced radio/TV technician for help

End-product labelling

The DA14531 TINY™ Module is labelled with its own FCC ID: **Y82-DA14531MOD**. If the FCC ID is not visible when the module is installed inside another device, then the outside of the end-product into which the module is installed must also display a label referring to the enclosed module. This exterior label can use the following or similar wording:

“Contains FCC ID: Y82-DA14531MOD”

11.3 IC (CANADA)

IC ID: 9576A-DA14531MOD

The DA14531 TINY™ Module is certified for the IC as a single-modular transmitter. The module meets IC modular approval and labelling requirements. The IC follows the same testing and rules as the FCC regarding certified modules in authorized equipment.

The module has been tested according to following standards:

- Radio: RSS-247 Issue 2: February 2017, RSS-Gen Issue 4: November 2014
- Health: RSS-102 Issue 5:2015

This device complies with Industry Canada licence-exempt RSS standard(s). Operation is subject to the following two conditions: (1) this device may not cause interference, and (2) this device must accept any interference, including interference that may cause undesired operation of the device.

Le présent appareil est conforme aux CNR d'Industrie Canada applicables aux appareils radio exempts de licence. L'exploitation est autorisée aux deux conditions suivantes: (1) l'appareil ne doit pas produire

de brouillage, et (2) l'utilisateur de l'appareil doit accepter tout brouillage radioélectrique subi, même si le brouillage est susceptible d'en compromettre le fonctionnement.

RF Exposure Statement

This device complies with IC radiation exposure limits set forth for an uncontrolled environment and meets RSS-102 of the IC radio frequency (RF) Exposure rules. This transmitter must not be co-located or operating in conjunction with any other antenna or transmitter.

Le présent appareil est conforme à l'exposition aux radiations IC définies pour un environnement non contrôlé et répond aux RSS-102 de la fréquence radio (RF) IC règles d'exposition. L'émetteur ne doit pas être colocalisé ni fonctionner conjointement avec à autre antenne ou autre émetteur.

OEM Responsibilities to comply with IC Regulations:

OEM integrator is responsible for testing their end-product for any additional compliance requirements needed for the module installation like IC ES003 (EMC). This can be combined with the FCC Part 15B test.

End-product labelling

The DA14531 TINY™ Module is labelled with its own IC ID: **9576A-DA14531MOD**. If the IC ID is not visible when the module is installed inside another device, then the outside of the end-product into which the module is installed must also display a label referring to the enclosed module. This exterior label can use the following or similar wording: **“Contains IC ID: 9576A-DA14531MOD”**

11.4 NCC (Taiwan)

DA14531MOD-00F0100



The DA14531 TINY™ Module has received compliance approval in accordance with the Telecommunications Act. The module has been tested according to following standard:

- Radio: Low Power Radio Frequency Devices Technical Regulations (LP0002)

End-product may need to follow additional requirement according to regulation EMC.

注意！

依據 低功率電波輻射性電機管理辦法
第十二條

經型式認證合格之低功率射頻電機，非經許可，公司、商號或使用者均不得擅自變更頻率、加大功率或變更原設計之特性及功能。

第十四條

低功率射頻電機之使用不得影響飛航安全及干擾合法通信；經發現有干擾現象時，應立即停用，並改善至無干擾時方得繼續使用。

前項合法通信，指依電信法規定作業之無線電通信。

低功率射頻電機須忍受合法通信或工業、科學及醫療用電波輻射性電機設備之干擾。

End-product labelling

The NCC ID can be applied directly on end-product's label.

11.5 MSIP (South Korea)



DA14531 TINY™ Module has received certification of conformity in accordance with Radio Waves Act. The module has been tested according to following standard:

- Radio: Ministry of Science and ICT Notice No. 2019-105

For end-product wireless test, you can refer to Dialog's own certification report so that the lab knows the module itself has passed although it still needs to be tested.

Additionally EMC for **wireless (KN301489)**.

End-product labelling

The MSIP ID can be applied directly on end-product's label. The ID should be clearly visible on the final end-product. The integrator of the module should refer to the labeling requirements for Korea available on the Korea Communications Commission (KCC) website.

11.6 Australia/New Zealand (RCM)

DA14531 TINY™ Module has not been certified for the Australian/ New Zealand market. However, the module's CE test reports can be used in part to demonstrate compliance in accordance with Short Range Devices- SRD Standards. The integrator of the module must construct a compliance folder with all relevant test reports: RF, EMC, Electrical Safety and DoC (Declaration of Conformity).

11.7 South Africa (ICASA)

South Africa certification is based on RED(CE) approval.



Approval is granted to print labels for the products as described below:

1. For use as Label on the product size: 80 mm (W) X 40 mm (H). To be printed on the product.
2. For use as Label on the package size: 80 mm (W) X 40 mm (H). To be printed on the package

End-product may need to follow additional requirement according to regulation EMC.

11.8 Brazil (Anatel)



The module has been tested and found to be compliant according to following Category II standards:

- ATO (Act) No 14448/2017

End-product may need to follow additional requirement according to regulation EMC.

“Este equipamento não tem direito à proteção contra interferência prejudicial e não pode causar interferência em sistemas devidamente autorizados.

Translation on the text:

"This equipment is not entitled to protection against harmful interference and must not cause interference in duly authorized systems."

11.9 China (SRRC)

Model no. DA14531MOD-00F0100

CMIIT ID:2020DP5042

The module has been tested and found to be compliant according to following standards

- 信部无【2002】353号

End-product may need to follow additional requirement according to regulation EMC.

11.10 MIC (JAPAN)



The DA14531 TINY™ Module has received type certification as required to conform to the technical standards regulated by the Ministry of Internal Affairs and Communications (MIC) of Japan pursuant to the Radio Act of Japan.

The module has been tested according to the following standard:

- Radio: JRL “Article 49-20 and the relevant articles of the Ordinance Regulating Radio” Equipment

End-product may need to follow additional requirement according to regulation EMC.

End-product labelling

The MIC ID can be applied directly on end-product's label. The end-product may bear the GITEKI mark and certification number so that is clear that the end-product contains a certified radio module. The following note may be show next to, below, above the GITEKI mark and certification number in order to indicate the presence of a certified radio module:

当該機器には電波法に基づく、技術基準適合証明等を受けた特定無線設備を装着している。

Translation on the text:

“This equipment contains specified radio equipment that has been certified to the Technical Regulation Conformity Certification under the Radio Law.”

11.11 Thailand (NBTC)

Model no. DA14531MOD-00F0100

NBTC SDoC ID: RT 1768

DA14531 TINY™ Module is compliant with NBTC requirements in Thailand.

End-product may need to follow additional requirement according to regulation EMC.

End-product labelling

End-products will have their own ID and labelling requirements.

11.12 India (WPC)

Model no. DA14531MOD-00F0100

Registration No: ETA-SD-20210402433

India certification is based on RED(CE) approval/ reports. There are no marking/ labeling requirements.

End-product may need to follow additional requirement according to regulation EMC.

12 Environmental Information

Dialog Semiconductor's suppliers certify that its products are in compliance with the requirements of REACH and Directive 2015/863/EU of the European Parliament on the restriction of the use of certain hazardous substances in electrical and electronic equipment. RoHS certificates from Dialog's suppliers are available on request.

13 Bluetooth® SIG Qualification

The DA14531 TINY™ Module is listed on the Bluetooth® SIG Website as a qualified product. The customers can refer to the following QDIDs to qualify their product:

- QDID 113957 for Host Subsystem
- QDID 113959 for Controller Subsystem
- QDID 138960 for Profile Subsystem

Revision History

Revision	Date	Description
3.3	27-Sep-2022	<ul style="list-style-type: none"> Table 9: Reel tape width changed to 24 mm instead of inches
3.2	13-Apr-2022	<ul style="list-style-type: none"> Updated Recommended Operating Conditions
3.1	31-May-2021	<ul style="list-style-type: none"> Corrected number of channels for 11-bit ENOB ADC Updated Regulatory Information (India)
3.0	08-Dec-2020	<ul style="list-style-type: none"> Added BD address information to features Corrected typical ambient temperature in Table 3 Updated Table 4 Updated Regulatory information on ICASA Added MSL qualification level and description
2.3	25-Aug-2020	<ul style="list-style-type: none"> Updated Regulatory information
2.2	26-Jun-2020	Various updates: <ul style="list-style-type: none"> Updated Regulatory information Various text updates
2.1	18-Jun-2020	Various updates: <ul style="list-style-type: none"> Added Soldering Updated Regulatory information Updated PCB Footprint Updated Characteristics
1.2	18-May-2020	Initial target datasheet version <ul style="list-style-type: none"> Various text updates Electrical Characteristics update from mini-characterization
1.1	23-Mar-2020	Initial target datasheet version <ul style="list-style-type: none"> Updated Regulatory Information section
1.0	6-Mar-2020	Initial target datasheet version

Status Definitions

Revision	Datasheet Status	Product Status	Definition
1.<n>	Target	Development	This datasheet contains the design specifications for product development. Specifications may be changed in any manner without notice.
2.<n>	Preliminary	Qualification	This datasheet contains the specifications and preliminary characterization data for products in pre-production. Specifications may be changed at any time without notice in order to improve the design.
3.<n>	Final	Production	This datasheet contains the final specifications for products in volume production. The specifications may be changed at any time in order to improve the design, manufacturing and supply. Major specification changes are communicated via Customer Product Notifications.
4.<n>	Obsolete	Archived	This datasheet contains the specifications for discontinued products. The information is provided for reference only.

RoHS Compliance

Dialog Semiconductor's suppliers certify that its products are in compliance with the requirements of Directive 2011/65/EU of the European Parliament on the restriction of the use of certain hazardous substances in electrical and electronic equipment. RoHS certificates from our suppliers are available on request.

IMPORTANT NOTICE AND DISCLAIMER

RENESAS ELECTRONICS CORPORATION AND ITS SUBSIDIARIES (“RENESAS”) PROVIDES TECHNICAL SPECIFICATIONS AND RELIABILITY DATA (INCLUDING DATASHEETS), DESIGN RESOURCES (INCLUDING REFERENCE DESIGNS), APPLICATION OR OTHER DESIGN ADVICE, WEB TOOLS, SAFETY INFORMATION, AND OTHER RESOURCES “AS IS” AND WITH ALL FAULTS, AND DISCLAIMS ALL WARRANTIES, EXPRESS OR IMPLIED, INCLUDING, WITHOUT LIMITATION, ANY IMPLIED WARRANTIES OF MERCHANTABILITY, FITNESS FOR A PARTICULAR PURPOSE, OR NON-INFRINGEMENT OF THIRD-PARTY INTELLECTUAL PROPERTY RIGHTS.

These resources are intended for developers who are designing with Renesas products. You are solely responsible for (1) selecting the appropriate products for your application, (2) designing, validating, and testing your application, and (3) ensuring your application meets applicable standards, and any other safety, security, or other requirements. These resources are subject to change without notice. Renesas grants you permission to use these resources only to develop an application that uses Renesas products. Other reproduction or use of these resources is strictly prohibited. No license is granted to any other Renesas intellectual property or to any third-party intellectual property. Renesas disclaims responsibility for, and you will fully indemnify Renesas and its representatives against, any claims, damages, costs, losses, or liabilities arising from your use of these resources. Renesas' products are provided only subject to Renesas' Terms and Conditions of Sale or other applicable terms agreed to in writing. No use of any Renesas resources expands or otherwise alters any applicable warranties or warranty disclaimers for these products.

(Disclaimer Rev.1.01 Jan 2024)

Corporate Headquarters

TOYOSU FORESIA, 3-2-24 Toyosu,
Koto-ku, Tokyo 135-0061, Japan
www.renesas.com

Trademarks



Renesas and the Renesas logo are trademarks of Renesas Electronics Corporation. All trademarks and registered trademarks are the property of their respective owners.

Contact Information







For further information on a product, technology, the most up-to-date version of a document, or your nearest sales office, please visit www.renesas.com/contact-us/.

Looking for pricing, stock, or lifecycle information?

Click below to explore more details on WIN SOURCE:

-  [View DA14531MOD-00F01002 on WIN SOURCE](#)
-  [Renesas Electronics America Information](#)

Optimize Your Supply Chain with WIN SOURCE Solutions

-  Global Sourcing Solution
-  Obsolete Management
-  Cost Control Management
-  Shortage Management
-  Alternative Solution
-  Excess Inventory Management