



**THE DATASHEET OF
FGHL75T65LQDT**



IGBT - Field Stop, Trench

75 A, 650 V

FGHL75T65LQDT

Description

Field stop 4th generation Low $V_{CE(sat)}$ IGBT technology and Full current rated copak Diode technology.

Features

- Maximum Junction Temperature: $T_J = 175^\circ\text{C}$
- Positive Temperature Co-efficient for Easy Parallel Operating
- High Current Capability
- Low Saturation Voltage: $V_{CE(sat)} = 1.15\text{ V (Typ.) @ } I_C = 75\text{ A}$
- 100% Of The Part Are Tested For I_{LM} (Note 2)
- Smooth & Optimized Switching
- Tight Parameter Distribution
- Co-Packed With Soft And Fast Recovery Diode
- RoHS Compliant

Typical Applications

- Solar Inverter
- UPS, ESS
- PFC, Converters

MAXIMUM RATINGS

Parameter	Symbol	Value	Unit
Collector to Emitter Voltage	V_{CES}	650	V
Gate to Emitter Voltage	V_{GES}	± 20	V
Transient Gate to Emitter Voltage		± 30	
Collector Current @ $T_C = 25^\circ\text{C}$ (Note 1)	I_C	80	A
Collector Current @ $T_C = 100^\circ\text{C}$		75	
Pulsed Collector Current (Note 2)	I_{LM}	300	A
Pulsed Collector Current (Note 3)	I_{CM}	300	A
Diode Forward Current @ $T_C = 25^\circ\text{C}$ (Note 1)	I_F	80	A
Diode Forward Current @ $T_C = 100^\circ\text{C}$		75	
Pulsed Diode Maximum Forward Current	I_{FM}	300	A
Maximum Power Dissipation @ $T_C = 25^\circ\text{C}$	P_D	469	W
Maximum Power Dissipation @ $T_C = 100^\circ\text{C}$		234	
Operating Junction Temperature / Storage Temperature Range	T_J, T_{STG}	-55 to +175	$^\circ\text{C}$
Maximum Lead Temp. For soldering Purposes, $\frac{1}{8}$ " from case for 5 seconds	T_L	260	$^\circ\text{C}$

Stresses exceeding those listed in the Maximum Ratings table may damage the device. If any of these limits are exceeded, device functionality should not be assumed, damage may occur and reliability may be affected.

1. Value limit by bond wire.
2. $V_{CC} = 400\text{ V}$, $V_{GE} = 15\text{ V}$, $I_C = 300\text{ A}$, Inductive Load, 100% Tested.
3. Repetitive rating: pulse width limited by max. Junction temperature.



ON Semiconductor®

www.onsemi.com

V_{CES}	I_C	$V_{CE(sat)}$
650 V	75 A	1.15 V

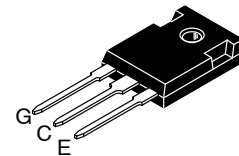
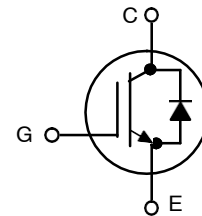

TO-247-3L
CASE 340CX

MARKING DIAGRAM

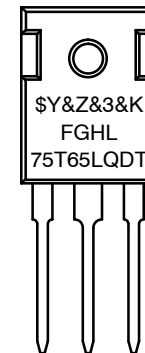

\$Y = ON Semiconductor Logo
&Z = Assembly Plant Code
&3 = 3-Digit Data Code
&K = 2-Digit Lot Traceability Code
FGHL75T65LQDT = Specific Device Code

ORDERING INFORMATION

Device	Package	Shipping
FGHL75T65LQDT	TO-247-3L	30 Units / Rail

FGHL75T65LQDT

THERMAL CHARACTERISTICS

Parameter	Symbol	Value	Units
Thermal Resistance Junction to Case, for IGBT	$R_{\theta JC}$	0.32	$^{\circ}C/W$
Thermal Resistance Junction to Case, for Diode	$R_{\theta JC}$	0.6	$^{\circ}C/W$
Thermal Resistance Junction to Ambient	$R_{\theta JA}$	40	$^{\circ}C/W$

ELECTRICAL CHARACTERISTICS ($T_J = 25^{\circ}C$ unless otherwise noted)

Parameter	Test Conditions	Symbol	Min	Typ	Max	Unit
-----------	-----------------	--------	-----	-----	-----	------

OFF CHARACTERISTICS

Collector-emitter Breakdown Voltage, Gate-emitter Short-circuited	$V_{GE} = 0 V, I_C = 1 mA$	BV_{CES}	650	-	-	V
Temperature Coefficient of Breakdown Voltage	$V_{GE} = 0 V, I_C = 1 mA$	$\Delta BV_{CES} / \Delta T_J$	-	0.6	-	$V/^{\circ}C$
Collector-emitter Cut-off Current, Gate-emitter Short-circuited	$V_{GE} = 0 V, V_{CE} = 650 V$	I_{CES}	-	-	250	μA
Gate Leakage Current, Collector-emitter Short-circuited	$V_{GE} = 20 V, V_{CE} = 0 V$	I_{GES}	-	-	± 400	nA

ON CHARACTERISTICS

Gate-emitter Threshold Voltage	$V_{GE} = V_{CE}, I_C = 75 mA$	$V_{GE(th)}$	3.0	4.5	6.0	V
Collector-emitter Saturation Voltage	$V_{GE} = 15 V, I_C = 75 A, T_J = 25^{\circ}C$	$V_{CE(sat)}$	-	1.15	1.35	V
	$V_{GE} = 15 V, I_C = 75 A, T_J = 175^{\circ}C$		-	1.22	-	

DYNAMIC CHARACTERISTICS

Input Capacitance	$V_{CE} = 30 V, V_{GE} = 0 V, f = 1 MHz$	C_{ies}	-	15300	-	pF
Output Capacitance		C_{oes}	-	181	-	
Reverse Transfer Capacitance		C_{res}	-	68	-	
Gate Charge Total	$V_{CE} = 400 V, I_C = 75 A, V_{GE} = 15 V$	Q_g	-	793	-	nC
Gate to Emitter Charge		Q_{ge}	-	72	-	
Gate to Collector Charge		Q_{gc}	-	248	-	

SWITCHING CHARACTERISTICS, INDUCTIVE LOAD

Turn-on Delay Time	$T_J = 25^{\circ}C$ $V_{CC} = 400 V, I_C = 37.5 A$ $R_g = 4.7 \Omega$ $V_{GE} = 15 V$	$t_{d(on)}$	-	45	-	ns
Rise Time		t_r	-	20	-	
Turn-off Delay Time		$t_{d(off)}$	-	608	-	
Fall Time		t_f	-	160	-	
Turn-on Switching Loss		E_{on}	-	0.78	-	mJ
Turn-off Switching Loss		E_{off}	-	1.36	-	
Total Switching Loss		E_{ts}	-	2.14	-	
Turn-on Delay Time	$T_J = 25^{\circ}C$ $V_{CC} = 400 V, I_C = 75 A$ $R_g = 4.7 \Omega$ $V_{GE} = 15 V$	$t_{d(on)}$	-	48	-	ns
Rise Time		t_r	-	40	-	
Turn-off Delay Time		$t_{d(off)}$	-	568	-	
Fall Time		t_f	-	128	-	
Turn-on Switching Loss		E_{on}	-	1.88	-	mJ
Turn-off Switching Loss		E_{off}	-	2.38	-	
Total Switching Loss		E_{ts}	-	4.26	-	

FGHL75T65LQDT

ELECTRICAL CHARACTERISTICS (T_J = 25°C unless otherwise noted) (continued)

Parameter	Test Conditions	Symbol	Min	Typ	Max	Unit
-----------	-----------------	--------	-----	-----	-----	------

SWITCHING CHARACTERISTICS, INDUCTIVE LOAD

Turn-on Delay Time	T _J = 175°C V _{CC} = 400 V, I _C = 37.5 A R _g = 4.7 Ω V _{GE} = 15 V	t _{d(on)}	–	44	–	ns	
Rise Time		t _r	–	24	–		
Turn-off Delay Time		t _{d(off)}	–	680	–		
Fall Time		t _f	–	256	–		
Turn-on Switching Loss		T _J = 175°C V _{CC} = 400 V, I _C = 75 A R _g = 4.7 Ω V _{GE} = 15 V	E _{on}	–	1.54	–	mJ
Turn-off Switching Loss			E _{off}	–	2.11	–	
Total Switching Loss			E _{ts}	–	3.65	–	
Turn-on Delay Time		T _J = 175°C V _{CC} = 400 V, I _C = 75 A R _g = 4.7 Ω V _{GE} = 15 V	t _{d(on)}	–	44	–	ns
Rise Time	t _r		–	44	–		
Turn-off Delay Time	t _{d(off)}		–	632	–		
Fall Time	t _f		–	184	–		
Turn-on Switching Loss	T _J = 175°C V _{CC} = 400 V, I _C = 75 A R _g = 4.7 Ω V _{GE} = 15 V		E _{on}	–	3.14	–	mJ
Turn-off Switching Loss			E _{off}	–	3.58	–	
Total Switching Loss			E _{ts}	–	6.72	–	

DIODE CHARACTERISTICS

Diode Forward Voltage	I _F = 75 A, T _J = 25°C	V _F	–	1.65	2.1	V
	I _F = 75 A, T _J = 175°C		–	1.55	–	
Reverse Recovery Energy	T _J = 25°C, V _R = 400 V, I _F = 37.5 A, di _F /dt = 1000 A/μs	E _{rec}	–	105	–	μJ
Reverse Recovery Time		T _{rr}	–	59	–	ns
Reverse Recovery Charge		Q _{rr}	–	574	–	nC
Reverse Recovery Current		I _{rr}	–	20	–	A
Reverse Recovery Energy	T _J = 25°C, V _R = 400 V, I _F = 75 A, di _F /dt = 1000 A/μs	E _{rec}	–	152	–	μJ
Reverse Recovery Time		T _{rr}	–	87	–	ns
Reverse Recovery Charge		Q _{rr}	–	794	–	nC
Reverse Recovery Current		I _{rr}	–	18	–	A
Reverse Recovery Energy	T _J = 175°C, V _R = 400 V, I _F = 37.5 A, di _F /dt = 1000 A/μs	E _{rec}	–	550	–	μJ
Reverse Recovery Time		T _{rr}	–	119	–	ns
Reverse Recovery Charge		Q _{rr}	–	2154	–	nC
Reverse Recovery Current		I _{rr}	–	36	–	A
Reverse Recovery Energy	T _J = 175°C, V _R = 400 V, I _F = 75 A, di _F /dt = 1000 A/μs	E _{rec}	–	764	–	μJ
Reverse Recovery Time		T _{rr}	–	145	–	ns
Reverse Recovery Charge		Q _{rr}	–	2947	–	nC
Reverse Recovery Current		I _{rr}	–	40	–	A

Product parametric performance is indicated in the Electrical Characteristics for the listed test conditions, unless otherwise noted. Product performance may not be indicated by the Electrical Characteristics if operated under different conditions.

FGHL75T65LQDT

TYPICAL CHARACTERISTICS

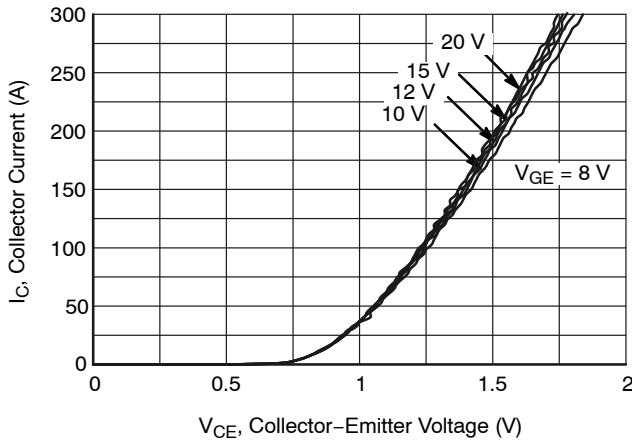

Figure 1. Typical Output Characteristics
($T_J = 25^\circ\text{C}$)

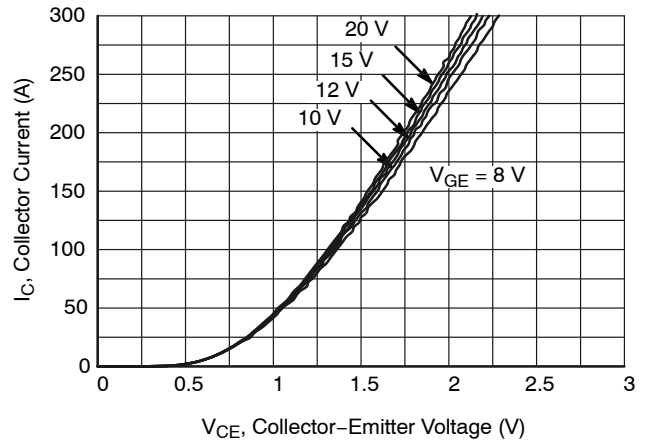

Figure 2. Typical Output Characteristics
($T_J = 175^\circ\text{C}$)

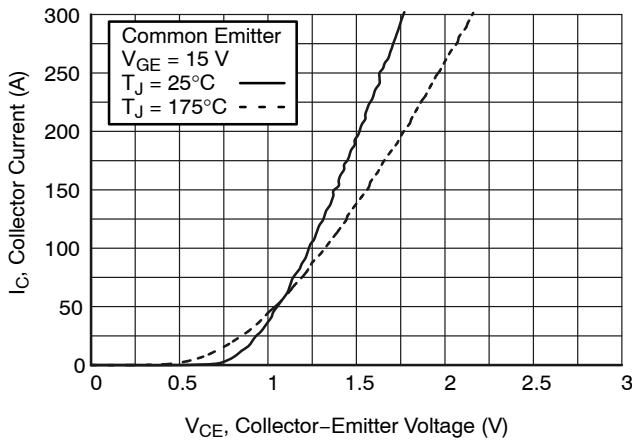

Figure 3. Typical Saturation Voltage Characteristics

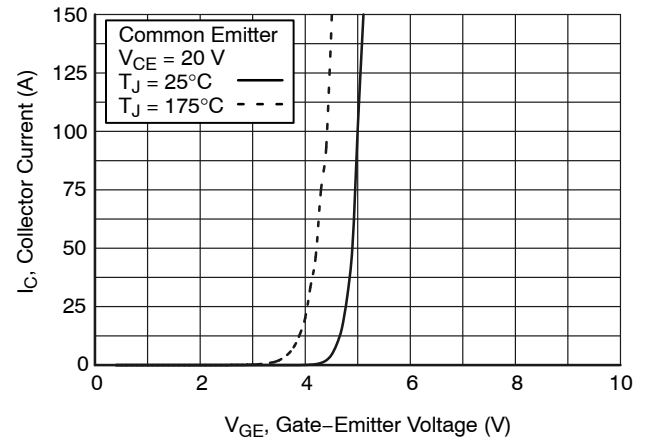

Figure 4. Typical Transfer Characteristics

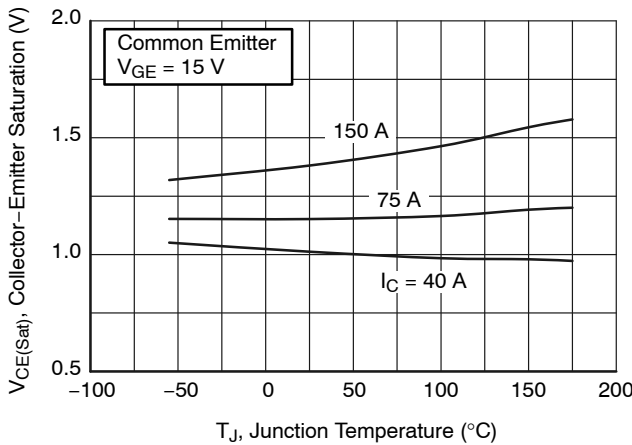

Figure 5. Saturation Voltage vs. Junction Temperature

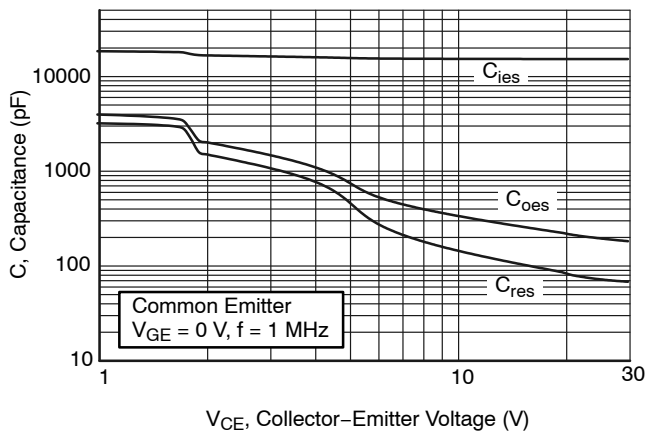

Figure 6. Capacitance Characteristics

FGHL75T65LQDT

TYPICAL CHARACTERISTICS (continued)

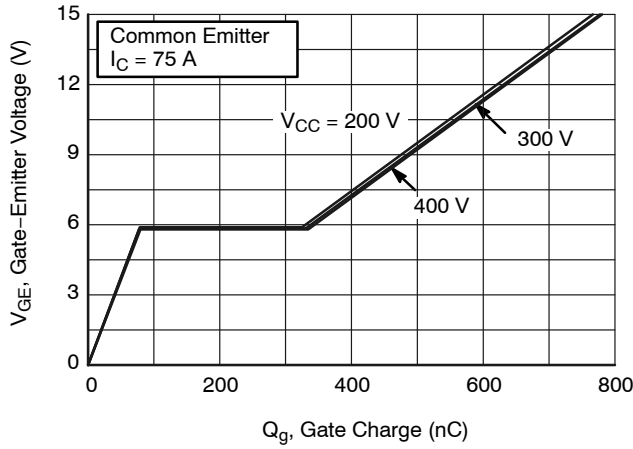

Figure 7. Gate Charge Characteristics

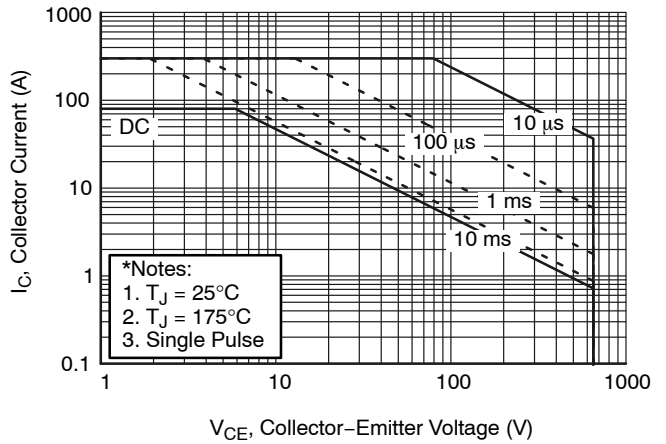

Figure 8. SOA Characteristics

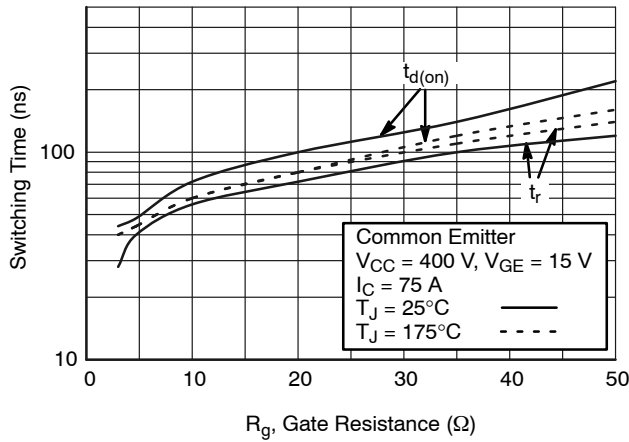

Figure 9. Turn-On Characteristics vs. Gate Resistance

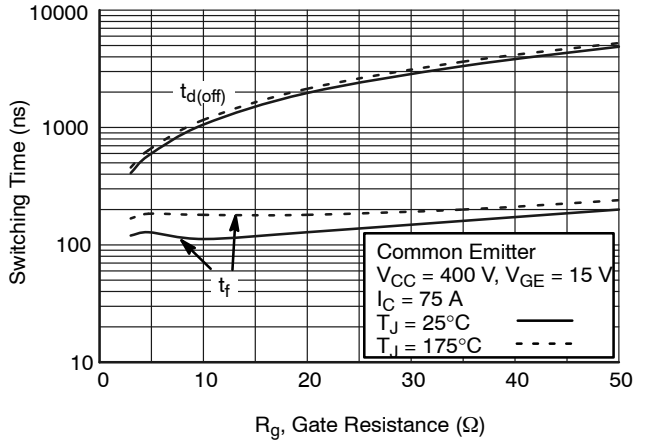

Figure 10. Turn-Off Characteristics vs. Gate Resistance

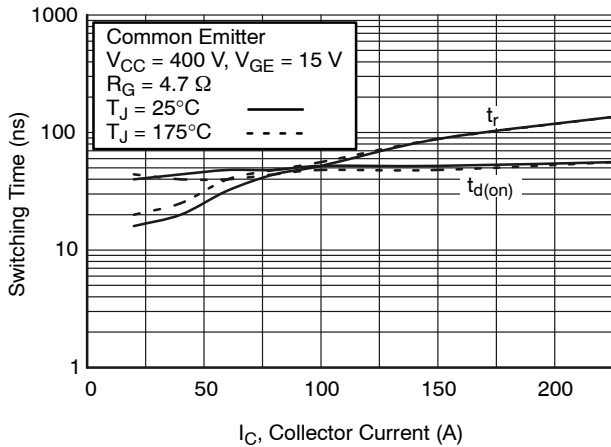

Figure 11. Turn-On Characteristics vs. Collector Current

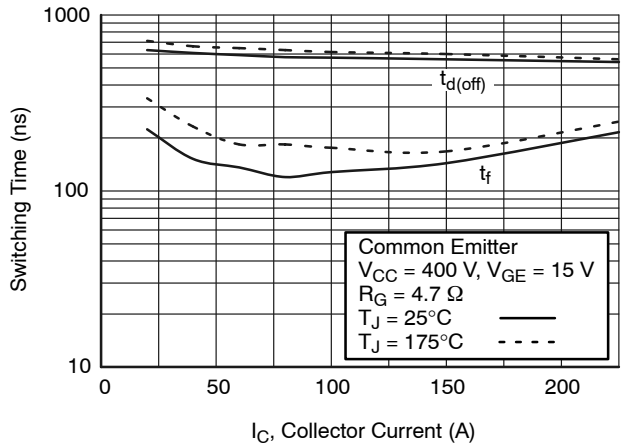

Figure 12. Turn-Off Characteristics vs. Collector Current

FGHL75T65LQDT

TYPICAL CHARACTERISTICS (continued)

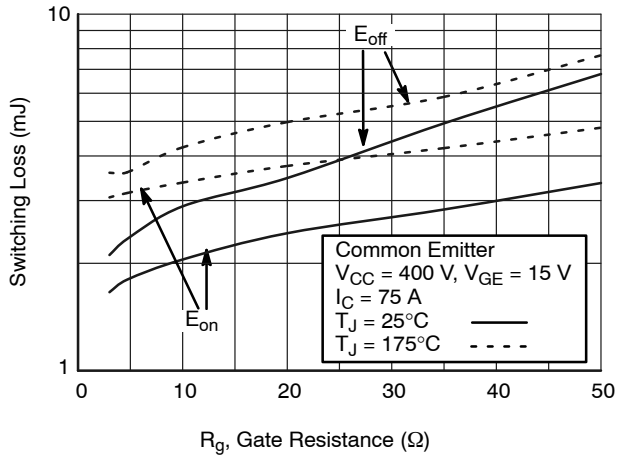

Figure 13. Switching Loss vs. Gate Resistance

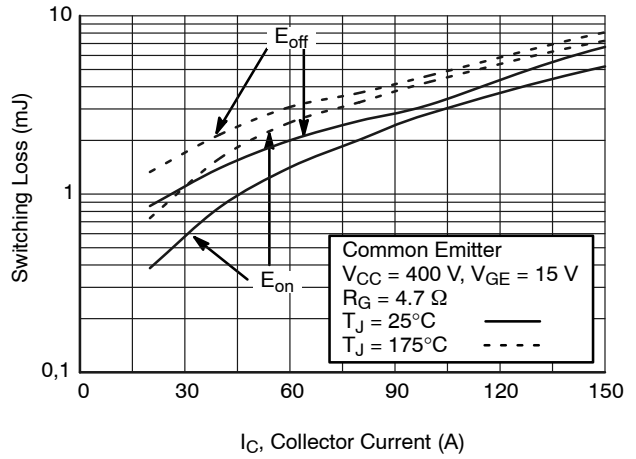

Figure 14. Switching Loss vs. Collector Current

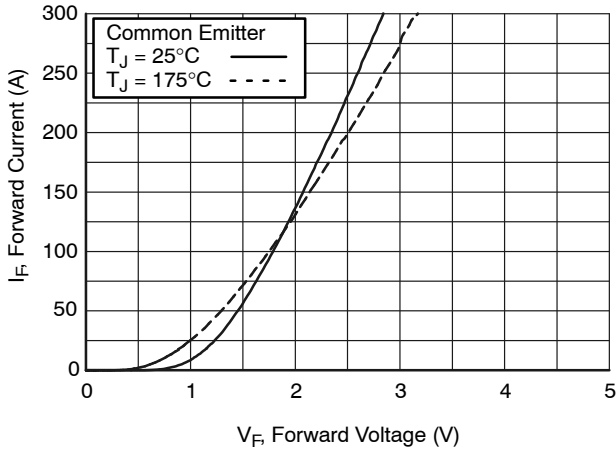

Figure 15. Forward Characteristics

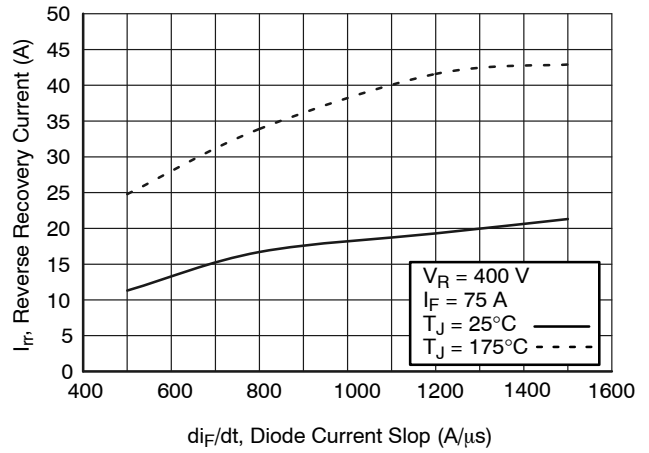

Figure 16. Reverse Recovery Current

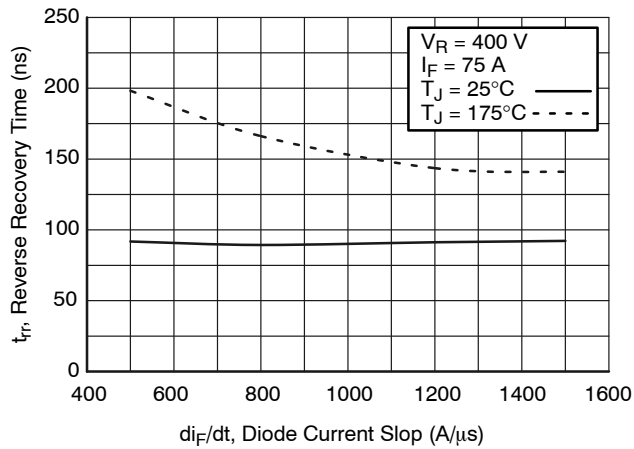

Figure 17. Reverse Recovery Time

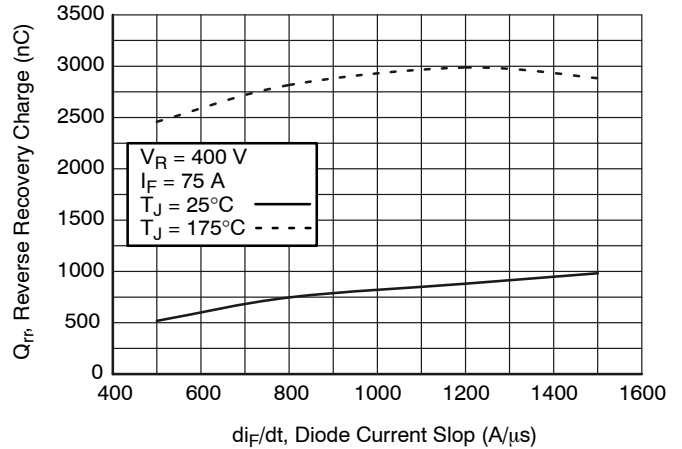

Figure 18. Stored Charge

FGHL75T65LQDT

TYPICAL PERFORMANCE CHARACTERISTICS (continued)

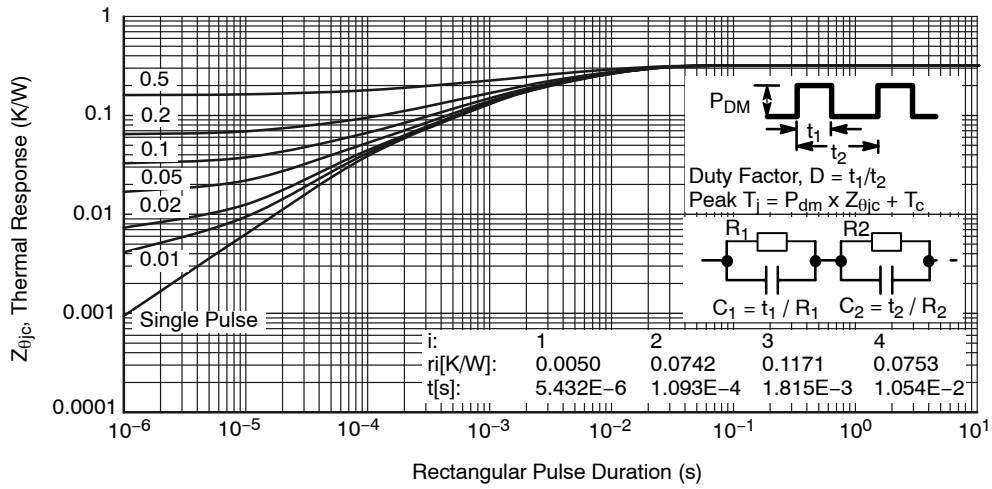

Figure 19. Transient Thermal Impedance of IGBT

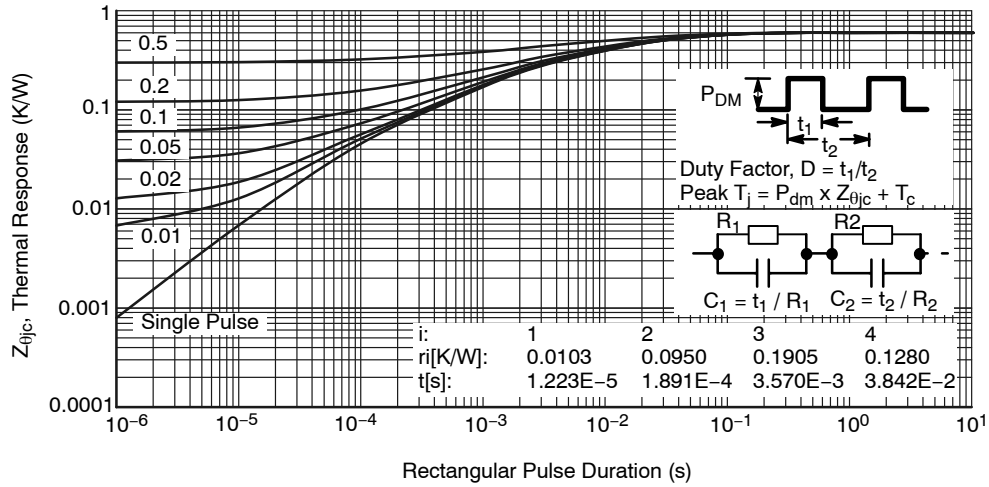

Figure 20. Transient Thermal Impedance of Diode

MECHANICAL CASE OUTLINE

PACKAGE DIMENSIONS

ON Semiconductor®



TO-247-3LD
CASE 340CX
ISSUE A

DATE 06 JUL 2020

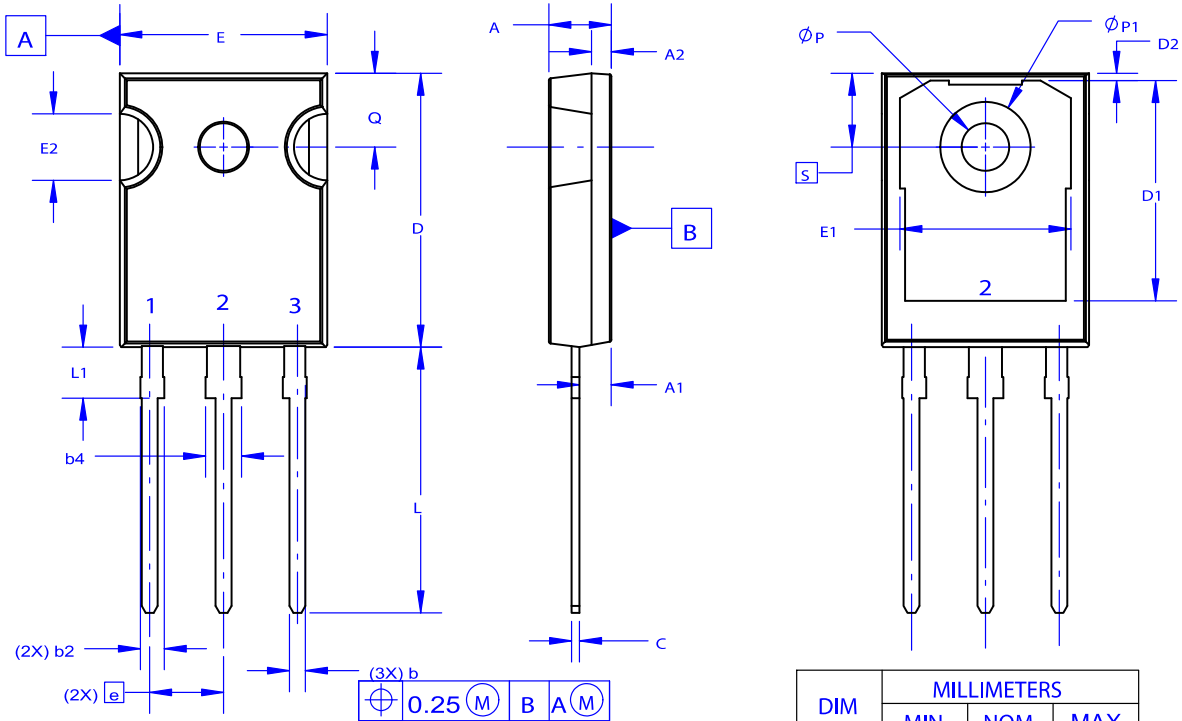
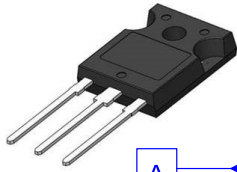

NOTES: UNLESS OTHERWISE SPECIFIED.

- A. DIMENSIONS ARE EXCLUSIVE OF BURRS, MOLD FLASH, AND TIE BAR EXTRUSIONS.
- B. ALL DIMENSIONS ARE IN MILLIMETERS.
- C. DRAWING CONFORMS TO ASME Y14.5 - 2009.
- D. DIMENSION A1 TO BE MEASURED IN THE REGION DEFINED BY L1.
- E. LEAD FINISH IS UNCONTROLLED IN THE REGION DEFINED BY L1.

DIM	MILLIMETERS		
	MIN	NOM	MAX
A	4.58	4.70	4.82
A1	2.20	2.40	2.60
A2	1.40	1.50	1.60
D	20.32	20.57	20.82
E	15.37	15.62	15.87
E2	4.96	5.08	5.20
e	~	5.56	~
L	19.75	20.00	20.25
L1	3.69	3.81	3.93
ØP	3.51	3.58	3.65
Q	5.34	5.46	5.58
S	5.34	5.46	5.58
b	1.17	1.26	1.35
b2	1.53	1.65	1.77
b4	2.42	2.54	2.66
c	0.51	0.61	0.71
D1	13.08	~	~
D2	0.51	0.93	1.35
E1	12.81	~	~
ØP1	6.60	6.80	7.00

GENERIC MARKING DIAGRAM*



- XXXXX = Specific Device Code
- A = Assembly Location
- Y = Year
- WW = Work Week
- G = Pb-Free Package

*This information is generic. Please refer to device data sheet for actual part marking. Pb-Free indicator, "G" or microdot "▪", may or may not be present. Some products may not follow the Generic Marking.

DOCUMENT NUMBER:	98AON93302G	Electronic versions are uncontrolled except when accessed directly from the Document Repository. Printed versions are uncontrolled except when stamped "CONTROLLED COPY" in red.
DESCRIPTION:	TO-247-3LD	PAGE 1 OF 1

ON Semiconductor and are trademarks of Semiconductor Components Industries, LLC dba ON Semiconductor or its subsidiaries in the United States and/or other countries. ON Semiconductor reserves the right to make changes without further notice to any products herein. ON Semiconductor makes no warranty, representation or guarantee regarding the suitability of its products for any particular purpose, nor does ON Semiconductor assume any liability arising out of the application or use of any product or circuit, and specifically disclaims any and all liability, including without limitation special, consequential or incidental damages. ON Semiconductor does not convey any license under its patent rights nor the rights of others.

onsemi, **Onsemi**, and other names, marks, and brands are registered and/or common law trademarks of Semiconductor Components Industries, LLC dba "**onsemi**" or its affiliates and/or subsidiaries in the United States and/or other countries. **onsemi** owns the rights to a number of patents, trademarks, copyrights, trade secrets, and other intellectual property. A listing of **onsemi**'s product/patent coverage may be accessed at www.onsemi.com/site/pdf/Patent-Marking.pdf. **onsemi** reserves the right to make changes at any time to any products or information herein, without notice. The information herein is provided "as-is" and **onsemi** makes no warranty, representation or guarantee regarding the accuracy of the information, product features, availability, functionality, or suitability of its products for any particular purpose, nor does **onsemi** assume any liability arising out of the application or use of any product or circuit, and specifically disclaims any and all liability, including without limitation special, consequential or incidental damages. Buyer is responsible for its products and applications using **onsemi** products, including compliance with all laws, regulations and safety requirements or standards, regardless of any support or applications information provided by **onsemi**. "Typical" parameters which may be provided in **onsemi** data sheets and/or specifications can and do vary in different applications and actual performance may vary over time. All operating parameters, including "Typicals" must be validated for each customer application by customer's technical experts. **onsemi** does not convey any license under any of its intellectual property rights nor the rights of others. **onsemi** products are not designed, intended, or authorized for use as a critical component in life support systems or any FDA Class 3 medical devices or medical devices with a same or similar classification in a foreign jurisdiction or any devices intended for implantation in the human body. Should Buyer purchase or use **onsemi** products for any such unintended or unauthorized application, Buyer shall indemnify and hold **onsemi** and its officers, employees, subsidiaries, affiliates, and distributors harmless against all claims, costs, damages, and expenses, and reasonable attorney fees arising out of, directly or indirectly, any claim of personal injury or death associated with such unintended or unauthorized use, even if such claim alleges that **onsemi** was negligent regarding the design or manufacture of the part. **onsemi** is an Equal Opportunity/Affirmative Action Employer. This literature is subject to all applicable copyright laws and is not for resale in any manner.

ADDITIONAL INFORMATION

TECHNICAL PUBLICATIONS:

Technical Library: www.onsemi.com/design/resources/technical-documentation
onsemi Website: www.onsemi.com

ONLINE SUPPORT: www.onsemi.com/support

For additional information, please contact your local Sales Representative at www.onsemi.com/support/sales

Looking for pricing, stock, or lifecycle information?

Click below to explore more details on WIN SOURCE:

 [View FGHL75T65LQDT on WIN SOURCE](#)

 [ON Semiconductor](#) Information

Optimize Your Supply Chain with WIN SOURCE Solutions

-  Global Sourcing Solution
-  Obsolete Management
-  Cost Control Management
-  Shortage Management
-  Alternative Solution
-  Excess Inventory Management