

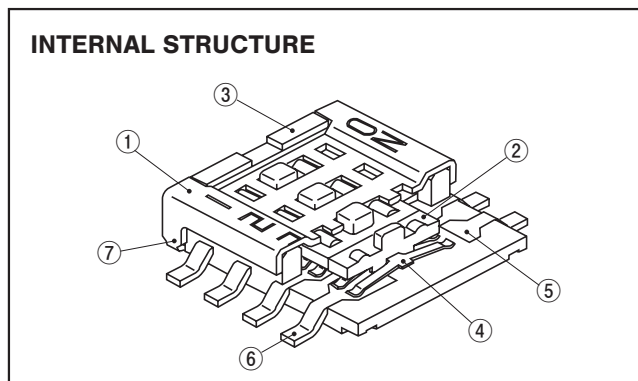

THE DATASHEET OF CVS-08TB

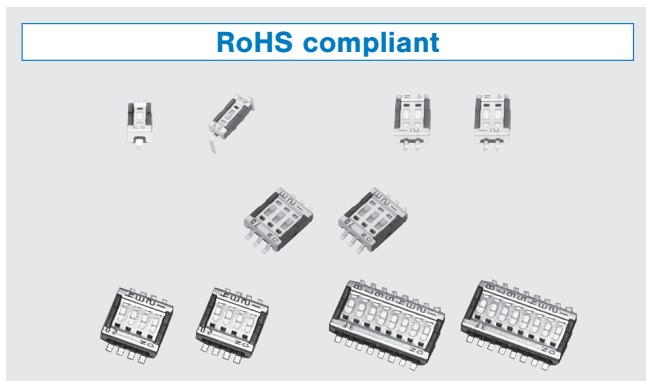

SLIDE SWITCHES (1 mm PITCH)



FEATURES

- RoHS compliant
- Lowest profile design of 1.45 mm
- Fine pitch of 1 mm
- Easy motion with knob height of 0.2 mm
- Resin material is UL Recognized 94V-0

Part name	Material
① Cover	Stainless steel, Gold-plated
② Slider	Polyamide
③ Housing	Polyphenylenesulfide
④ Slider contact	Stainless steel, Gold-plated
⑤ Fixed contact	Copper alloy, Gold-plated
⑥ Terminal pin	
⑦ Earth terminal	Stainless steel, Gold-plated

PART NUMBER DESIGNATION

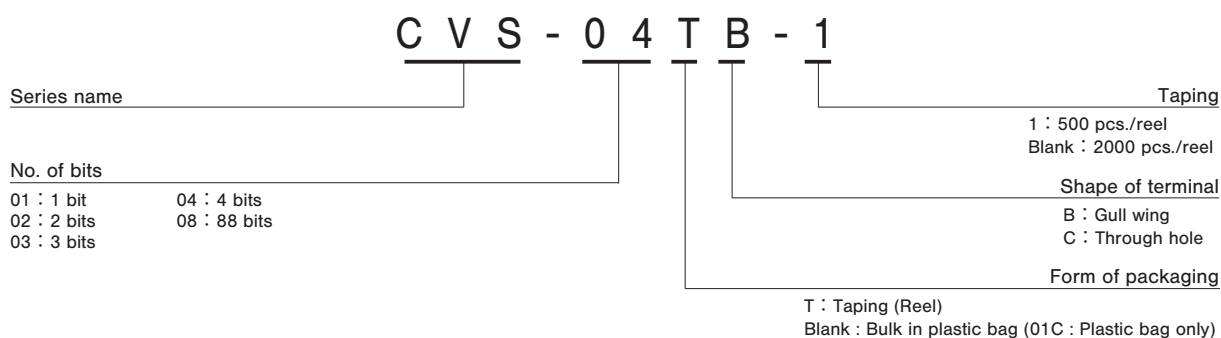

LIST OF PART NUMBERS

No. of bits	Form of packaging	Shape of terminals	B (Gull wing)	C (Through hole)	Packaging quantity
1	Taping		CVS-01TB-1		500 pcs./reel
	Taping		CVS-01TB		2000 pcs./reel
	Plastic bag		CVS-01B	CVS-01C	100 pcs./pack
2	Taping		CVS-02TB-1		500 pcs./reel
	Taping		CVS-02TB		2000 pcs./reel
	Plastic bag		CVS-02B		100 pcs./pack
3	Taping		CVS-03TB-1		500 pcs./reel
	Taping		CVS-03TB		2000 pcs./reel
	Plastic bag		CVS-03B		100 pcs./pack

No. of bits	Form of packaging	Shape of terminals	B (Gull wing)	C (Through hole)	Packaging quantity
4	Taping		CVS-04TB-1		500 pcs./reel
	Taping		CVS-04TB		2000 pcs./reel
	Plastic bag		CVS-04B		100 pcs./pack
8	Taping		CVS-08TB-1		500 pcs./reel
	Taping		CVS-08TB		2000 pcs./reel
	Plastic bag		CVS-08B		100 pcs./pack

CVS

SLIDE SWITCHES (1 mm PITCH)

STANDARD SPECIFICATIONS

Operating temp. range	- 40 ~ 85 °C
Storage temp. range	
Sealing	Non-washable
Net weight	Approx. 0.028g (CVS-01B) Approx. 0.031g (CVS-01C) Approx. 0.041g (CVS-02B) Approx. 0.054g (CVS-03B) Approx. 0.067g (CVS-04B) Approx. 0.13 g (CVS-08B)

ELECTRICAL CHARACTERISTICS

Contact rating Non-switching Switching Minimum	DC50 V 100 mA DC6 V, 100 mA DC24 V, 25 mA DC20 mV 1 μA
Contact resistance	200 mΩ maximum
Insulation resistance	100 MΩ (DC100 V) minimum
Dielectric strength	AC250 V, 60 s

MECHANICAL CHARACTERISTICS

Operating force	3 N {0.306 kgf} maximum
Stop strength	6 N {0.61 kgf}, 60 s
Solderability	245 ± 3 °C, 2 ~ 3 s
Soldering heat	Reflow: 255 °C (Peak temperature) (Please refer to the profile below)
	Manual soldering: 350 ± 10 °C, 3 ~ 4 s
Shear (Adhesion)	5 N {0.51 kgf} 10 s
Substrate bending	Width 90 mm, bend 3 mm, 5 s, 1 time
Pull-off strength	5 N {0.51 kgf} 10 s

{ } : Reference only

ENVIRONMENTAL CHARACTERISTICS

Vibration	Amplitude 1.5 mm or Acceleration 98 m/s ² , 10-500 Hz, 3 directions for 10 cycles each
Shock	490 m/s ² , 11 ms 6 directions for 3 times each
Load life	Continuous load 1000 cycles, DC6 ± 0.5 V, 100 ± 10 mA
Humidity	-10 ~ 65 °C, Relative humidity 0 ~ 96 %, 24 h for 10 cycles
High temp. exposure	85 °C, 96 h
Low temp. exposure	-40 °C, 96 h
Thermal shock	-40 (0.5 h) ~ 85 °C (0.5 h), 5 cycles

Reflow profile for soldering heat evaluation

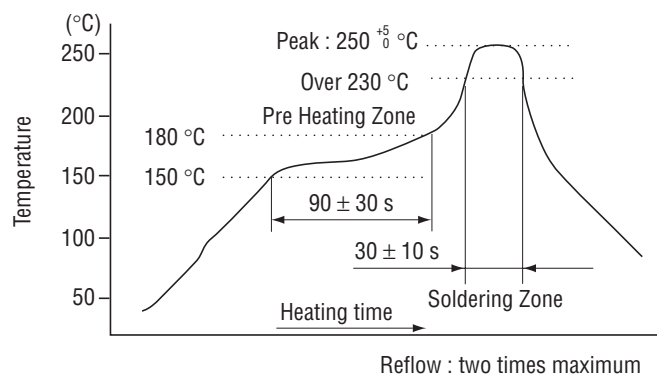

SLIDE SWITCHES (1 mm PITCH)

OUTLINE DIMENSIONS

Unless otherwise specified, tolerance : ± 0.3 (Unit : mm)

● CVS-01B

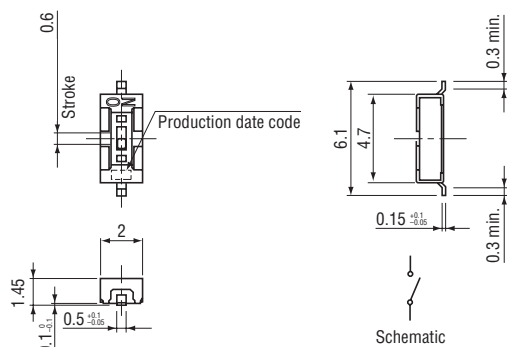

● CVS-01C

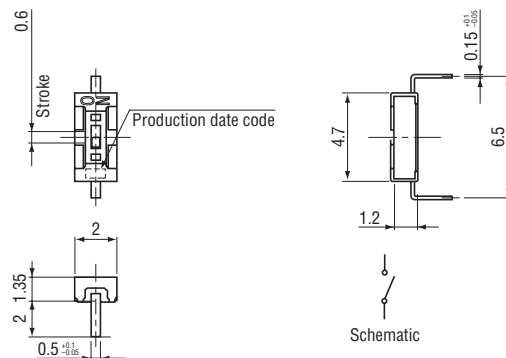

● CVS-□□B

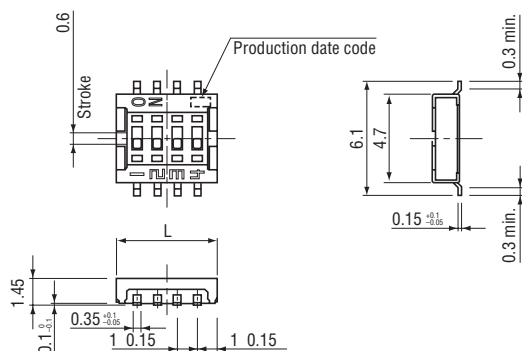

Part number	Schematic	No. of bits	L dimension
CVS-02		2	3
CVS-03		3	4
CVS-04		4	5
CVS-08		8	9

RECOMMENDED P.C.B. PAD OUTLINE DIMENSIONS

(Unit : mm)

● CVS-01B

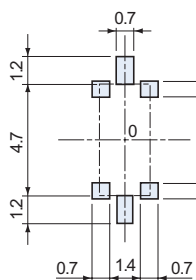

● CVS-02B

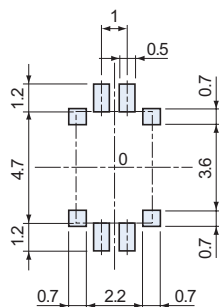

● CVS-03B

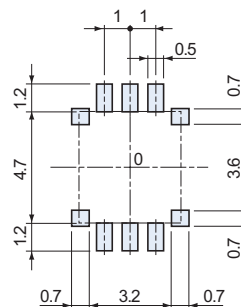

● CVS-04B

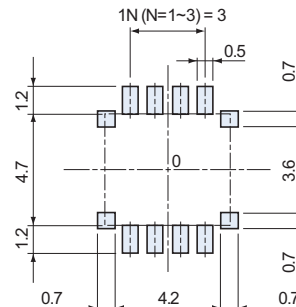

● CVS-08B

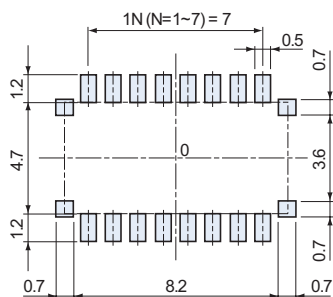

SIZE OF P.C.B. PROCESSING

(Unit : mm)

● CVS-01C

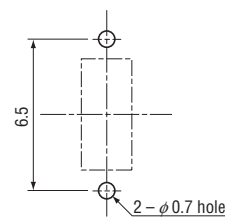

CVS

SLIDE SWITCHES (1 mm PITCH)

PACKAGING SPECIFICATIONS

<Taping packaging specifications>

- Taping version is packaged in 2000 pcs. or 500 pcs. per reel. Orders will be accepted for units of 2000 pcs., i.e., 2000, 4000, 6000 pcs., etc. or for units of 500 pcs., i.e., 500, 1000, 1500 pcs., etc.
- Taping version is boxed with two reels.
Maximum number of consecutive missing pieces = 2
Leader length and reel dimension are shown in the diagrams below:

● Embossed tape dimensions

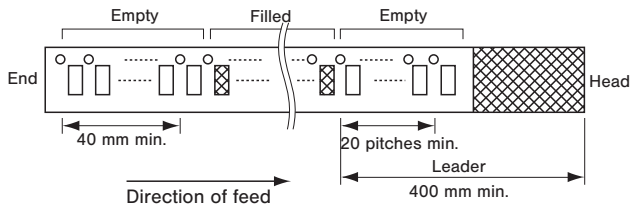

● Reel dimensions

(Conforms to JIS C 0806-3)
(In accordance with EIAJ ET-7200A)

(Unit: mm)

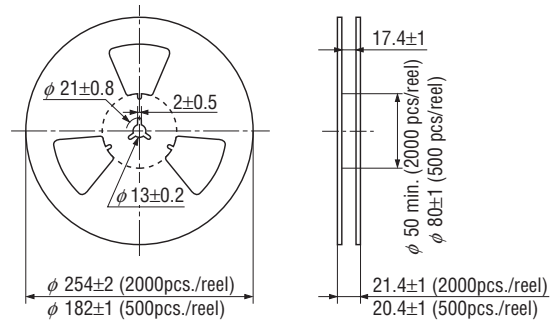

● 1 bit

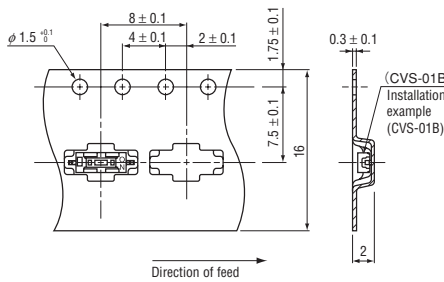

● 2 bits

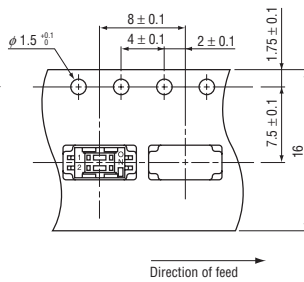

● 3 bits

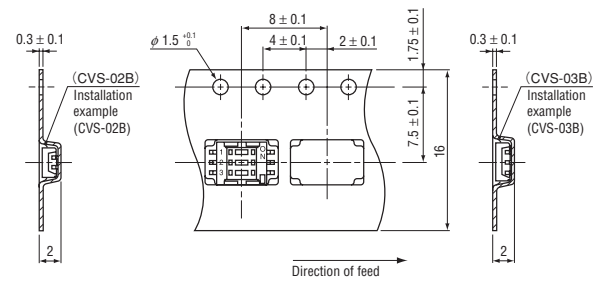

● 4 bits

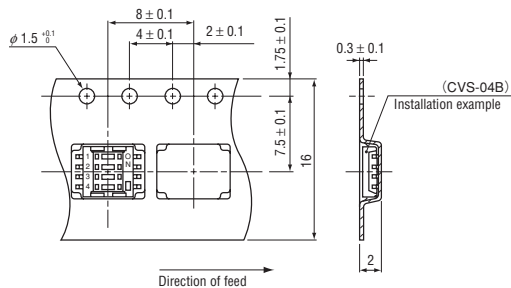

● 8 bits

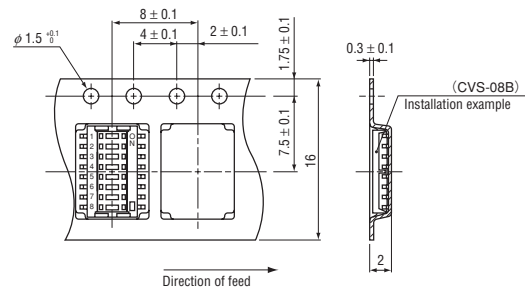



<Bulk pack specifications>

- The smallest unit of bulk pack in a plastic bag is 10 pcs. per pack. Orders will be accepted for unit of minimum 10 pcs., i.e., 10, 20, 30 pcs., etc.
- Boxing of bulk in a plastic bag is performed with 100 pcs. (standard 500 pcs.) per box.

Looking for pricing, stock, or lifecycle information?

Click below to explore more details on WIN SOURCE:

-  [View CVS-08TB on WIN SOURCE](#)
-  [Nidec Copal Electronics Information](#)

Optimize Your Supply Chain with WIN SOURCE Solutions

-  Global Sourcing Solution
-  Obsolete Management
-  Cost Control Management
-  Shortage Management
-  Alternative Solution
-  Excess Inventory Management