



**THE DATASHEET OF
BGSA14M2N10E6327XTSA1**



BGSA14M2N10

Ultra small antenna tuning SP4T

Features

- Ultra low R_{ON} resistance of 0.85Ω in ON state
- Low C_{OFF} capacitance of 160 fF in OFF state
- High RF operating peak voltage handling of 45 V in OFF state
- MIPI RFFE 2.1 control interface
- Extremely low current consumption of 22 μ A
- 4 default USID addresses via external USID_SEL pin
- Small form factor 0.95 mm x 1.3 mm (MSL1, 260 °C per JEDEC J-STD-020)



Potential applications

- Impedance, Antenna and Inductance Tuning
- Tunable Filters

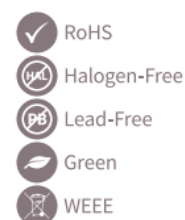

Description

The BGSA14M2N10 is a very small single-pole four throws (SP4T) Antenna Tuning switch optimized for RF applications up to 7.125GHz. Its MIPI RFFE digital control interface allows easy implementation and best flexibility when operated in cellular mobile RF Front-End designs.

The BGSA14M2N10 includes 4 low R_{ON} ports making it ideal for high Q tuning applications. Thanks to its high RF voltage ruggedness, it is suited for switching any reactive devices such as inductors and capacitors in RF matching circuits without significant losses.

Block diagram and ordering information

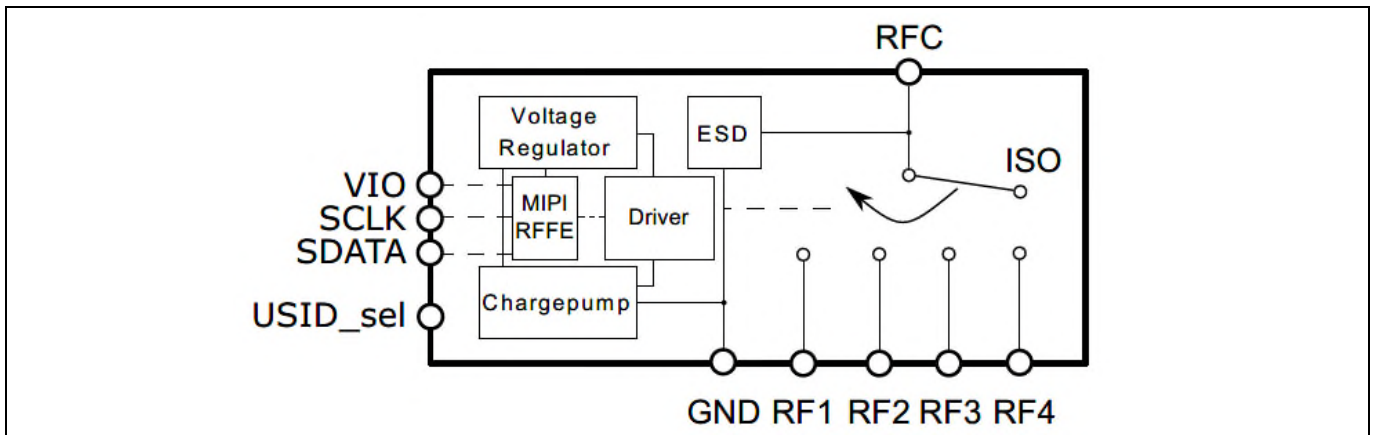

Figure 1 BGSA14M2N10 Block diagram

Table 1 Ordering Information

Type	Marking	Package	Product name
BGSA14M2N10	M2	TSNP-10-9	BGSA 14M2N10 E6327

For more technical information, please contact our Technical Assistance Center or your local Infineon representative.

Trademarks

All referenced product or service names and trademarks are the property of their respective owners.

Edition 2019-09-16
Published by
Infineon Technologies AG
81726 München, Germany

© 2022 Infineon Technologies AG.
All Rights Reserved.

Do you have a question about this document?

Email: erratum@infineon.com

Document reference

ifx1

IMPORTANT NOTICE

The information given in this document shall in no event be regarded as a guarantee of conditions or characteristics ("Beschaffenheitsgarantie").

With respect to any examples, hints or any typical values stated herein and/or any information regarding the application of the product, Infineon Technologies hereby disclaims any and all warranties and liabilities of any kind, including without limitation warranties of non-infringement of intellectual property rights of any third party.

In addition, any information given in this document is subject to customer's compliance with its obligations stated in this document and any applicable legal requirements, norms and standards concerning customer's products and any use of the product of Infineon Technologies in customer's applications.

The data contained in this document is exclusively intended for technically trained staff. It is the responsibility of customer's technical departments to evaluate the suitability of the product for the intended application and the completeness of the product information given in this document with respect to such application.

For further information on the product, technology, delivery terms and conditions and prices please contact your nearest Infineon Technologies office (www.infineon.com).



WARNINGS

Due to technical requirements products may contain dangerous substances. For information on the types in question please contact your nearest Infineon Technologies office.



Except as otherwise explicitly approved by Infineon Technologies in a written document signed by authorized representatives of Infineon Technologies, Infineon Technologies' products may not be used in any applications where a failure of the product or any consequences of the use thereof can reasonably be expected to result in personal injury.

Looking for pricing, stock, or lifecycle information?

Click below to explore more details on WIN SOURCE:

-  [View BGSA14M2N10E6327XTSA1 on WIN SOURCE](#)
-  [Infineon Technologies Information](#)

Optimize Your Supply Chain with WIN SOURCE Solutions

-  Global Sourcing Solution
-  Obsolete Management
-  Cost Control Management
-  Shortage Management
-  Alternative Solution
-  Excess Inventory Management