



**THE DATASHEET OF
PCA6416APW,118**





PCA6416A

Low-voltage translating 16-bit I²C-bus/SMBus I/O expander with interrupt output, reset, and configuration registers

Rev. 2. — 10 January 2013

Product data sheet

1. General description

The PCA6416A is a 16-bit general purpose I/O expander that provides remote I/O expansion for most microcontroller families via the I²C-bus interface.

NXP I/O expanders provide a simple solution when additional I/Os are needed while keeping interconnections to a minimum, for example, in battery-powered mobile applications for interfacing to sensors, push buttons, keypad, etc. In addition to providing a flexible set of GPIOs, it simplifies interconnection of a processor running at one voltage level to I/O devices operating at a different (usually higher) voltage level. The PCA6416A has built-in level shifting feature that makes these devices extremely flexible in mixed signal environments where communication between incompatible I/O voltages is required. Its wide V_{DD} range of 1.65 V to 5.5 V on the dual power rail allows seamless communications with next-generation low voltage microprocessors and microcontrollers on the interface side (SDA/SCL) and peripherals at a higher voltage on the port side.

There are two supply voltages for PCA6416A: $V_{DD(I2C-bus)}$ and $V_{DD(P)}$. $V_{DD(I2C-bus)}$ provides the supply voltage for the interface at the master side (for example, a microcontroller) and the $V_{DD(P)}$ provides the supply for core circuits and Port P. The bidirectional voltage level translation in the PCA6416A is provided through $V_{DD(I2C-bus)}$. $V_{DD(I2C-bus)}$ should be connected to the V_{DD} of the external SCL/SDA lines. This indicates the V_{DD} level of the I²C-bus to the PCA6416A. The voltage level on Port P of the PCA6416A is determined by the $V_{DD(P)}$.

The PCA6416A register set consists of four pairs of 8-bit Configuration, Input, Output, and Polarity Inversion registers.

At power-on, the I/Os are configured as inputs. However, the system master can enable the I/Os as either inputs or outputs by writing to the I/O configuration bits. The data for each input or output is kept in the corresponding input or output register. The polarity of the Input Port register can be inverted with the Polarity Inversion register, saving external logic gates.

The system master can reset the PCA6416A in the event of a time-out or other improper operation by asserting a LOW in the \overline{RESET} input. The power-on reset puts the registers in their default state and initializes the I²C-bus/SMBus state machine. The \overline{RESET} pin causes the same reset/initialization to occur without depowering the part.

The PCA6416A open-drain interrupt (\overline{INT}) output is activated when any input state differs from its corresponding Input Port register state and is used to indicate to the system master that an input state has changed.



$\overline{\text{INT}}$ can be connected to the interrupt input of a microcontroller. By sending an interrupt signal on this line, the remote I/O can inform the microcontroller if there is incoming data on its ports without having to communicate via the I²C-bus. Thus, the PCA6416A can remain a simple slave device.

The device Port P outputs have 25 mA sink capabilities for directly driving LEDs while consuming low device current.

One hardware pin (ADDR) can be used to program and vary the fixed I²C-bus address and allow up to two devices to share the same I²C-bus or SMBus.

2. Features and benefits

- I²C-bus to parallel port expander
- Operating power supply voltage range of 1.65 V to 5.5 V
- Allows bidirectional voltage-level translation and GPIO expansion between:
 - ◆ 1.8 V SCL/SDA and 1.8 V, 2.5 V, 3.3 V or 5 V Port P
 - ◆ 2.5 V SCL/SDA and 1.8 V, 2.5 V, 3.3 V or 5 V Port P
 - ◆ 3.3 V SCL/SDA and 1.8 V, 2.5 V, 3.3 V or 5 V Port P
 - ◆ 5 V SCL/SDA and 1.8 V, 2.5 V, 3.3 V or 5 V Port P
- Low standby current consumption:
 - ◆ 1.5 μA typical at 5 V V_{DD}
 - ◆ 1.0 μA typical at 3.3 V V_{DD}
- Schmitt-trigger action allows slow input transition and better switching noise immunity at the SCL and SDA inputs
 - ◆ $V_{\text{hys}} = 0.18 \text{ V}$ (typical) at 1.8 V
 - ◆ $V_{\text{hys}} = 0.25 \text{ V}$ (typical) at 2.5 V
 - ◆ $V_{\text{hys}} = 0.33 \text{ V}$ (typical) at 3.3 V
 - ◆ $V_{\text{hys}} = 0.5 \text{ V}$ (typical) at 5 V
- 5 V tolerant I/O ports
- Active LOW reset input ($\overline{\text{RESET}}$)
- Open-drain active LOW interrupt output ($\overline{\text{INT}}$)
- 400 kHz Fast-mode I²C-bus
- Input/Output Configuration register
- Polarity Inversion register
- Internal power-on reset
- Power-up with all channels configured as inputs
- No glitch on power-up
- Noise filter on SCL/SDA inputs
- Latched outputs with 25 mA drive maximum capability for directly driving LEDs
- Latch-up performance exceeds 100 mA per JESD 78, Class II
- ESD protection exceeds JESD 22
 - ◆ 2000 V Human-Body Model (A114-A)
 - ◆ 1000 V Charged-Device Model (C101)
- Packages offered: TSSOP24, HWQFN24, VFBGA24

3. Ordering information

Table 1. Ordering information

Type number	Topside marking	Package		Version
		Name	Description	
PCA6416AEV	416A	VFBGA24	plastic very thin fine-pitch ball grid array package; 24 balls; body 3 × 3 × 0.85 mm	SOT1199-1
PCA6416AHF	416A	HWQFN24	plastic thermal enhanced very very thin quad flat package; no leads; 24 terminals; body 4 × 4 × 0.75 mm	SOT994-1
PCA6416APW	PCA6416A	TSSOP24	plastic thin shrink small outline package; 24 leads; body width 4.4 mm	SOT355-1

3.1 Ordering options

Table 2. Ordering options

Type number	Orderable part number	Package	Packing method	Minimum order quantity	Temperature
PCA6416AEV	PCA6416AEVJ	VFBGA24	Reel pack, SMD, 13-inch	6000	T _{amb} = -40 °C to +85 °C
PCA6416AHF	PCA6416AHF,128	HWQFN24	Reel pack, SMD, 13-inch, turned	6000	T _{amb} = -40 °C to +85 °C
PCA6416APW	PCA6416APW,118	TSSOP24	Reel pack, SMD, 13-inch	2500	T _{amb} = -40 °C to +85 °C

4. Block diagram

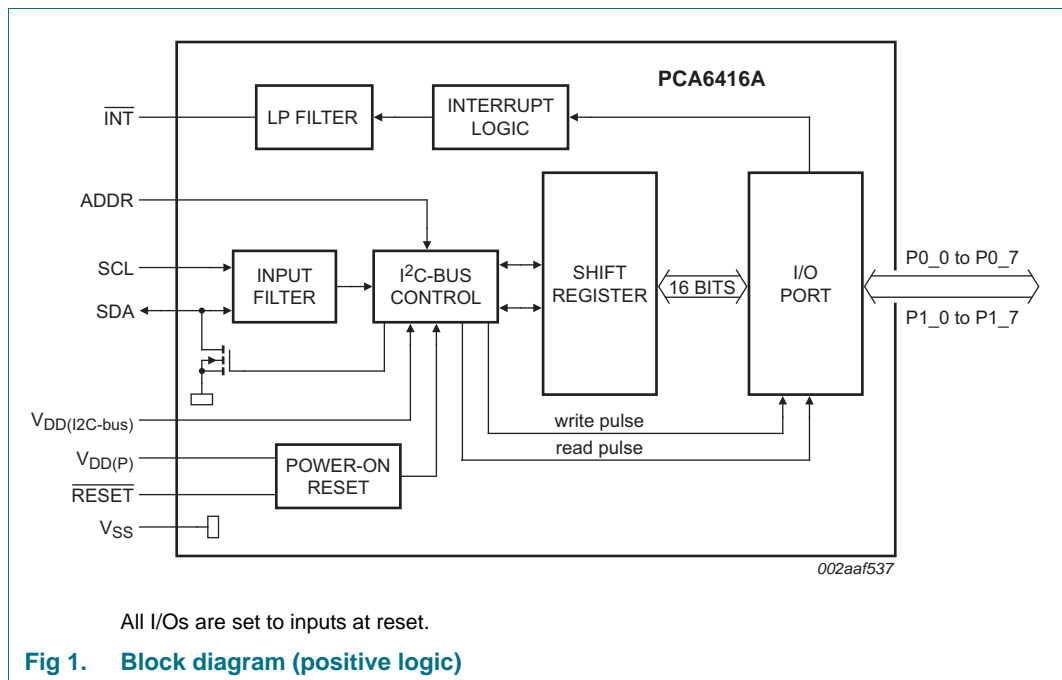

5. Pinning information

5.1 Pinning

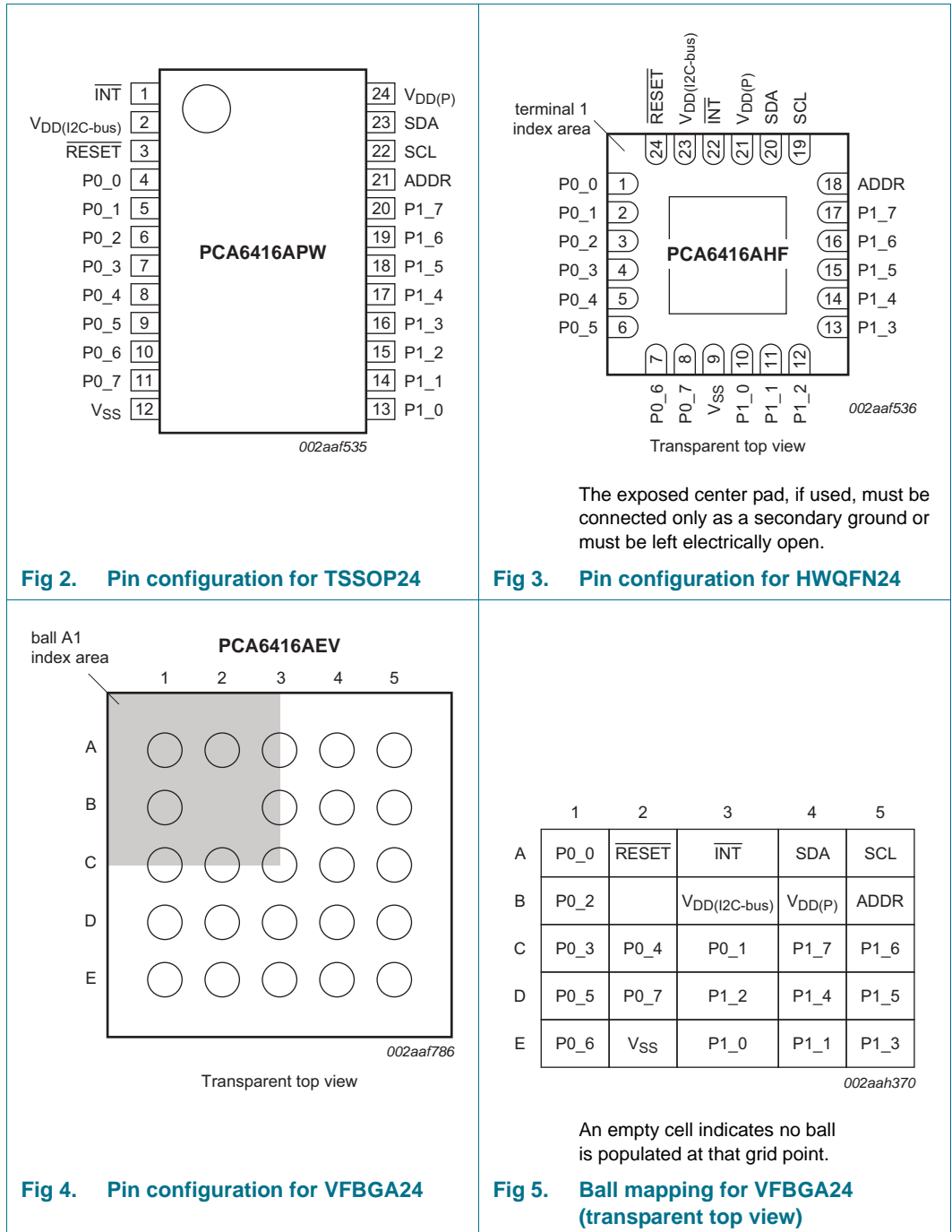

5.2 Pin description

Table 3. Pin description

Symbol	Pin			Description
	TSSOP24	HWQFN24	VFBGA24	
$\overline{\text{INT}}$	1	22	A3	Interrupt output. Connect to $V_{\text{DD(I}^2\text{C-bus)}}$ or $V_{\text{DD(P)}}$ through a pull-up resistor.
$V_{\text{DD(I}^2\text{C-bus)}}$	2	23	B3	Supply voltage of I ² C-bus. Connect directly to the V_{DD} of the external I ² C master. Provides voltage-level translation.
$\overline{\text{RESET}}$	3	24	A2	Active LOW reset input. Connect to $V_{\text{DD(I}^2\text{C-bus)}}$ through a pull-up resistor if no active connection is used.
P0_0 ^[1]	4	1	A1	Port 0 input/output 0.
P0_1 ^[1]	5	2	C3	Port 0 input/output 1.
P0_2 ^[1]	6	3	B1	Port 0 input/output 2.
P0_3 ^[1]	7	4	C1	Port 0 input/output 3.
P0_4 ^[1]	8	5	C2	Port 0 input/output 4.
P0_5 ^[1]	9	6	D1	Port 0 input/output 5.
P0_6 ^[1]	10	7	E1	Port 0 input/output 6.
P0_7 ^[1]	11	8	D2	Port 0 input/output 7.
V_{SS}	12	9	E2	Ground.
P1_0 ^[2]	13	10	E3	Port 1 input/output 0.
P1_1 ^[2]	14	11	E4	Port 1 input/output 1.
P1_2 ^[2]	15	12	D3	Port 1 input/output 2.
P1_3 ^[2]	16	13	E5	Port 1 input/output 3.
P1_4 ^[2]	17	14	D4	Port 1 input/output 4.
P1_5 ^[2]	18	15	D5	Port 1 input/output 5.
P1_6 ^[2]	19	16	C5	Port 1 input/output 6.
P1_7 ^[2]	20	17	C4	Port 1 input/output 7.
ADDR	21	18	B5	Address input. Connect directly to $V_{\text{DD(P)}}$ or ground.
SCL	22	19	A5	Serial clock bus. Connect to $V_{\text{DD(I}^2\text{C-bus)}}$ through a pull-up resistor.
SDA	23	20	A4	Serial data bus. Connect to $V_{\text{DD(I}^2\text{C-bus)}}$ through a pull-up resistor.
$V_{\text{DD(P)}}$	24	21	B4	Supply voltage of PCA6416A for Port P.

[1] Pins P0_0 to P0_7 correspond to bits P0.0 to P0.7. At power-on, all I/O are configured as input.

[2] Pins P1_0 to P1_7 correspond to bits P1.0 to P1.7. At power-on, all I/O are configured as input.

6. Voltage translation

Table 4 shows how to set up V_{DD} levels for the necessary voltage translation between the I²C-bus and the PCA6416A.

Table 4. Voltage translation

V _{DD(I2C-bus)} (SDA and SCL of I ² C master)	V _{DD(P)} (Port P)
1.8 V	1.8 V
1.8 V	2.5 V
1.8 V	3.3 V
1.8 V	5 V
2.5 V	1.8 V
2.5 V	2.5 V
2.5 V	3.3 V
2.5 V	5 V
3.3 V	1.8 V
3.3 V	2.5 V
3.3 V	3.3 V
3.3 V	5 V
5 V	1.8 V
5 V	2.5 V
5 V	3.3 V
5 V	5 V

7. Functional description

Refer to [Figure 1 “Block diagram \(positive logic\)”](#).

7.1 Device address

The address of the PCA6416A is shown in [Figure 6](#).

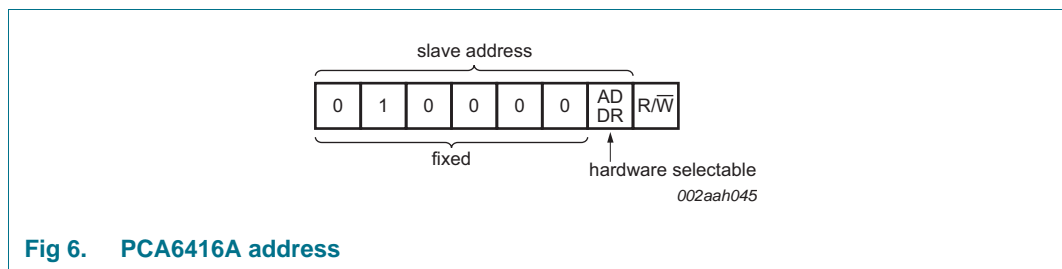

Fig 6. PCA6416A address

ADDR is the hardware address package pin and is held to either HIGH (logic 1) or LOW (logic 0) to assign one of the two possible slave addresses. The last bit of the slave address (R/W) defines the operation (read or write) to be performed. A HIGH (logic 1) selects a read operation, while a LOW (logic 0) selects a write operation.

7.2 Interface definition

Table 5. Interface definition

Byte	Bit							
	7 (MSB)	6	5	4	3	2	1	0 (LSB)
I ² C-bus slave address	L	H	L	L	L	L	ADDR	R/ \bar{W}
I/O data bus	P0.7	P0.6	P0.5	P0.4	P0.3	P0.2	P0.1	P0.0
	P1.7	P1.6	P1.5	P1.4	P1.3	P1.2	P1.1	P1.0

7.3 Pointer register and command byte

Following the successful acknowledgement of the address byte, the bus master sends a command byte, which is stored in the Pointer register in the PCA6416A. The lower three bits of this data byte state the operation (read or write) and the internal registers (Input, Output, Polarity Inversion, or Configuration) that will be affected. This register is write only.

Once a new command has been sent, the register that was last addressed continues to be accessed by reads until a new command byte is sent.

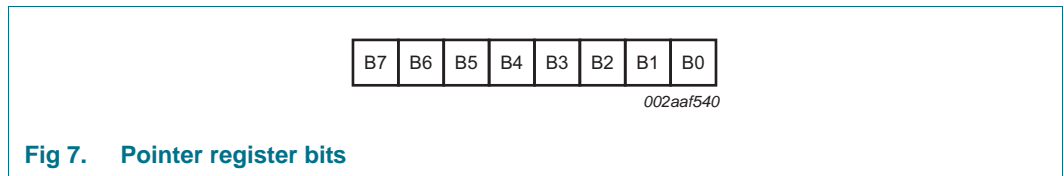

Fig 7. Pointer register bits

Table 6. Command byte

Pointer register bits								Command byte	Register	Protocol	Power-up default
B7	B6	B5	B4	B3	B2	B1	B0				
0	0	0	0	0	0	0	0	00h	Input port 0	read byte	xxxx xxxx ^[1]
0	0	0	0	0	0	0	1	01h	Input port 1	read byte	xxxx xxxx
0	0	0	0	0	0	1	0	02h	Output port 0	read/write byte	1111 1111
0	0	0	0	0	0	1	1	03h	Output port 1	read/write byte	1111 1111
0	0	0	0	0	1	0	0	04h	Polarity Inversion port 0	read/write byte	0000 0000
0	0	0	0	0	1	0	1	05h	Polarity Inversion port 1	read/write byte	0000 0000
0	0	0	0	0	1	1	0	06h	Configuration port 0	read/write byte	1111 1111
0	0	0	0	0	1	1	1	07h	Configuration port 1	read/write byte	1111 1111

[1] Undefined.

7.4 Register descriptions

7.4.1 Input port registers (00h, 01h)

The Input port registers (registers 0 and 1) reflect the incoming logic levels of the pins, regardless of whether the pin is defined as an input or an output by the Configuration register. The Input port registers are read only; writes to these registers have no effect. The default value 'X' is determined by the externally applied logic level. An Input port register read operation is performed as described in [Section 8.2](#).

Table 7. Input port 0 register (address 00h)

Bit	7	6	5	4	3	2	1	0
Symbol	I0.7	I0.6	I0.5	I0.4	I0.3	I0.2	I0.1	I0.0
Default	X	X	X	X	X	X	X	X

Table 8. Input port 1 register (address 01h)

Bit	7	6	5	4	3	2	1	0
Symbol	I1.7	I1.6	I1.5	I1.4	I1.3	I1.2	I1.1	I1.0
Default	X	X	X	X	X	X	X	X

7.4.2 Output port registers (02h, 03h)

The Output port registers (registers 2 and 3) shows the outgoing logic levels of the pins defined as outputs by the Configuration register. Bit values in these registers have no effect on pins defined as inputs. In turn, reads from these registers reflect the value that was written to these registers, **not** the actual pin value. A register pair write is described in [Section 8.1](#) and a register pair read is described in [Section 8.2](#).

Table 9. Output port 0 register (address 02h)

Bit	7	6	5	4	3	2	1	0
Symbol	O0.7	O0.6	O0.5	O0.4	O0.3	O0.2	O0.1	O0.0
Default	1	1	1	1	1	1	1	1

Table 10. Output port 1 register (address 03h)

Bit	7	6	5	4	3	2	1	0
Symbol	O1.7	O1.6	O1.5	O1.4	O1.3	O1.2	O1.1	O1.0
Default	1	1	1	1	1	1	1	1

7.4.3 Polarity inversion registers (04h, 05h)

The Polarity inversion registers (registers 4 and 5) allow polarity inversion of pins defined as inputs by the Configuration register. If a bit in these registers is set (written with '1'), the corresponding port pin's polarity is inverted in the input register. If a bit in this register is cleared (written with a '0'), the corresponding port pin's polarity is retained. A register pair write is described in [Section 8.1](#) and a register pair read is described in [Section 8.2](#).

Table 11. Polarity inversion port 0 register (address 04h)

Bit	7	6	5	4	3	2	1	0
Symbol	N0.7	N0.6	N0.5	N0.4	N0.3	N0.2	N0.1	N0.0
Default	0	0	0	0	0	0	0	0

Table 12. Polarity inversion port 1 register (address 05h)

Bit	7	6	5	4	3	2	1	0
Symbol	N1.7	N1.6	N1.5	N1.4	N1.3	N1.2	N1.1	N1.0
Default	0	0	0	0	0	0	0	0

7.4.4 Configuration registers (06h, 07h)

The Configuration registers (registers 6 and 7) configure the direction of the I/O pins. If a bit in these registers is set to 1, the corresponding port pin is enabled as a high-impedance input. If a bit in these registers is cleared to 0, the corresponding port pin is enabled as an output. A register pair write is described in [Section 8.1](#) and a register pair read is described in [Section 8.2](#).

Table 13. Configuration port 0 register (address 06h)

Bit	7	6	5	4	3	2	1	0
Symbol	C0.7	C0.6	C0.5	C0.4	C0.3	C0.2	C0.1	C0.0
Default	1	1	1	1	1	1	1	1

Table 14. Configuration port 1 register (address 07h)

Bit	7	6	5	4	3	2	1	0
Symbol	C1.7	C1.6	C1.5	C1.4	C1.3	C1.2	C1.1	C1.0
Default	1	1	1	1	1	1	1	1

7.5 I/O port

When an I/O is configured as an input, FETs Q1 and Q2 are off, which creates a high-impedance input. The input voltage may be raised above $V_{DD(P)}$ to a maximum of 5.5 V.

If the I/O is configured as an output, Q1 or Q2 is enabled, depending on the state of the Output port register. In this case, there are low-impedance paths between the I/O pin and either $V_{DD(P)}$ or V_{SS} . The external voltage applied to this I/O pin should not exceed the recommended levels for proper operation.

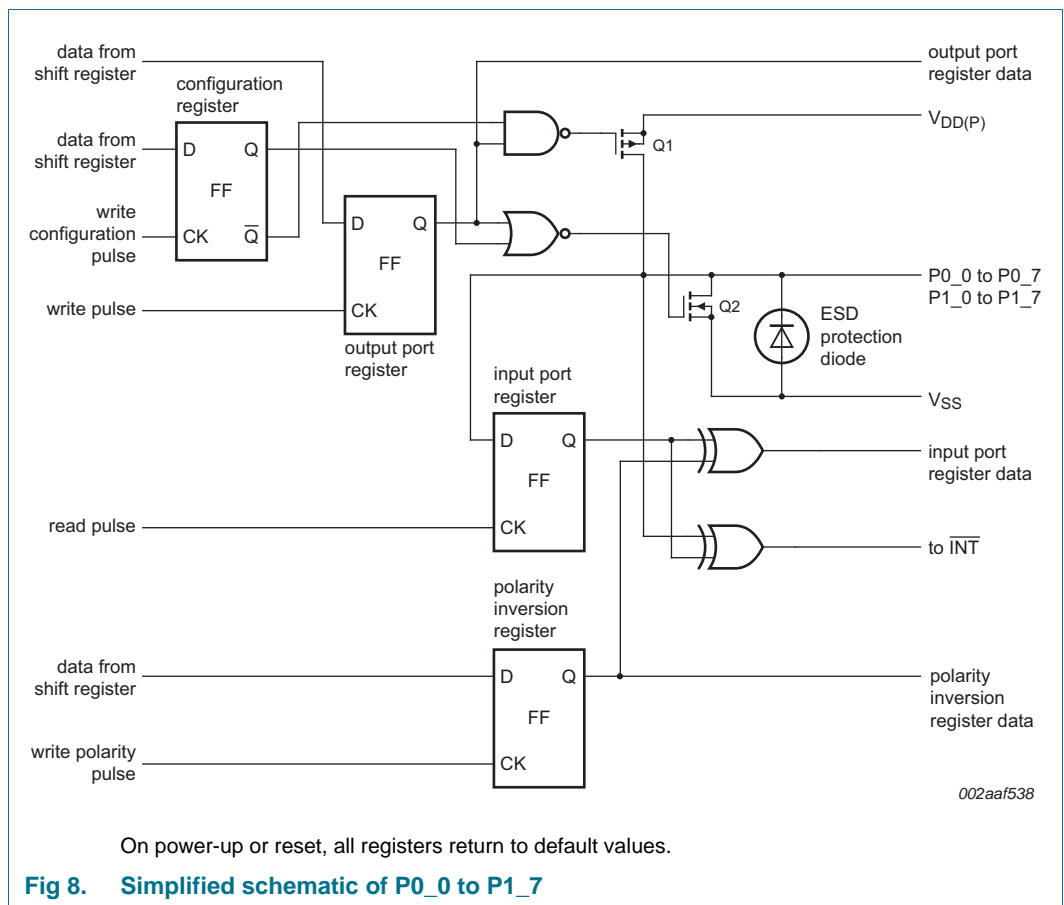

Fig 8. Simplified schematic of P0_0 to P1_7

7.6 Power-on reset

When power (from 0 V) is applied to $V_{DD(P)}$, an internal power-on reset holds the PCA6416A in a reset condition until $V_{DD(P)}$ has reached V_{POR} . At that time, the reset condition is released and the PCA6416A registers and I²C-bus/SMBus state machine initializes to their default states. After that, $V_{DD(P)}$ must be lowered to below V_{POR} and back up to the operating voltage for a power-reset cycle. See [Section 9.2 "Power-on reset requirements"](#).

7.7 Reset input ($\overline{\text{RESET}}$)

The $\overline{\text{RESET}}$ input can be asserted to initialize the system while keeping the $V_{\text{DD(P)}}$ at its operating level. A reset can be accomplished by holding the $\overline{\text{RESET}}$ pin LOW for a minimum of $t_{\text{w(rst)}}$. The PCA6416A registers and I²C-bus/SMBus state machine are changed to their default state once $\overline{\text{RESET}}$ is LOW (0). When $\overline{\text{RESET}}$ is HIGH (1), the I/O levels at the P port can be changed externally or through the master. This input requires a pull-up resistor to $V_{\text{DD(I2C-bus)}}$ if no active connection is used.

7.8 Interrupt output ($\overline{\text{INT}}$)

An interrupt is generated by any rising or falling edge of the port inputs in the Input mode. After time $t_{\text{v(INT)}}$, the signal $\overline{\text{INT}}$ is valid. The interrupt is reset when data on the port changes back to the original value or when data is read from the port that generated the interrupt (see [Figure 12](#)). Resetting occurs in the Read mode at the acknowledge (ACK) or not acknowledge (NACK) bit after the rising edge of the SCL signal. Interrupts that occur during the ACK or NACK clock pulse can be lost (or be very short) due to the resetting of the interrupt during this pulse. Any change of the I/Os after resetting is detected and is transmitted as $\overline{\text{INT}}$.

A pin configured as an output cannot cause an interrupt. Changing an I/O from an output to an input may cause a false interrupt to occur, if the state of the pin does not match the contents of the Input Port register.

The $\overline{\text{INT}}$ output has an open-drain structure and requires pull-up resistor to $V_{\text{DD(P)}}$ or $V_{\text{DD(I2C-bus)}}$ depending on the application. $\overline{\text{INT}}$ should be connected to the voltage source of the device that requires the interrupt information.

8. Bus transactions

The PCA6416A is an I²C-bus slave device. Data is exchanged between the master and PCA6416A through write and read commands using I²C-bus. The two communication lines are a serial data line (SDA) and a serial clock line (SCL). Both lines must be connected to a positive supply via a pull-up resistor when connected to the output stages of a device. Data transfer may be initiated only when the bus is not busy.

8.1 Write commands

Data is transmitted to the PCA6416A by sending the device address and setting the Least Significant Bit (LSB) to a logic 0 (see [Figure 6](#) for device address). The command byte is sent after the address and determines which register receives the data that follows the command byte.

The eight registers within the PCA6416A are configured to operate as four register pairs. The four pairs are input ports, output ports, polarity inversion and configuration registers. After sending data to one register, the next data byte is sent to the other register in the pair (see [Figure 9](#) and [Figure 10](#)). For example, if the first byte is sent to Output Port 1 (register 3), the next byte is stored in Output Port 0 (register 2).

There is no limit on the number of data bytes sent in one write transmission. In this way, the host can continuously update a register pair independently of the other registers or the host can simply update a single register.

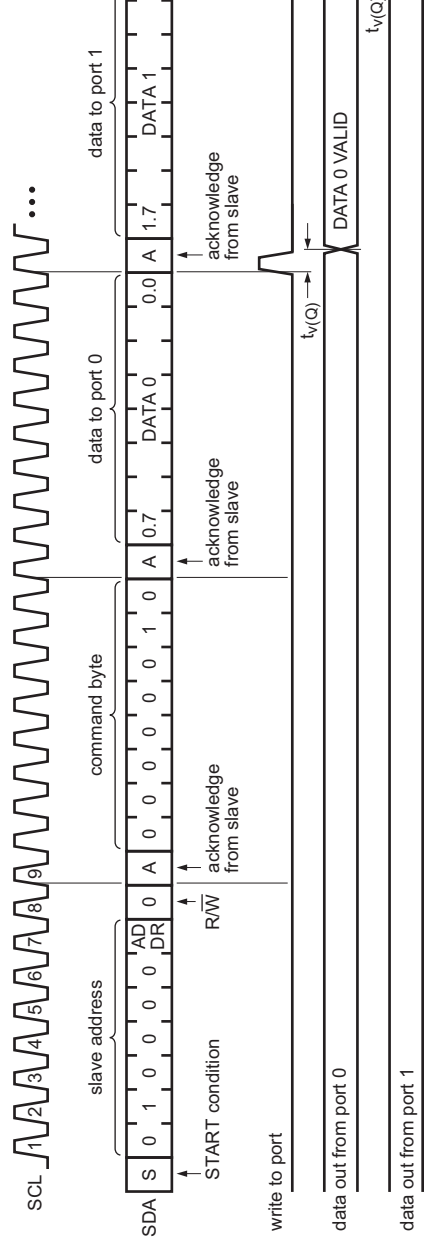

Fig 9. Write to Output port register

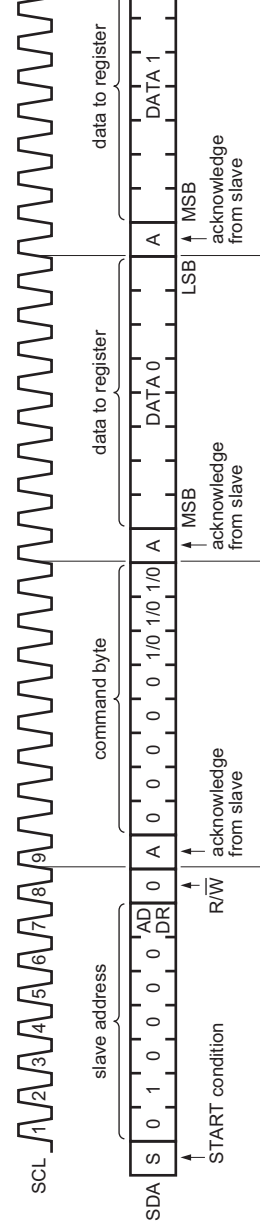

Fig 10. Write to device registers

8.2 Read commands

To read data from the PCA6416A, the bus master must first send the PCA6416A address with the least significant bit set to a logic 0 (see [Figure 6](#) for device address). The command byte is sent after the address and determines which register is to be accessed.

After a restart, the device address is sent again, but this time the least significant bit is set to a logic 1. Data from the register defined by the command byte is sent by the PCA6416A (see [Figure 11](#) and [Figure 12](#)). Data is clocked into the register on the rising edge of the ACK clock pulse. After the first byte is read, additional bytes may be read, but the data now reflects the information in the other register in the pair. For example, if Input Port 1 is read, the next byte read is Input Port 0. There is no limit on the number of data bytes received in one read transmission, but on the final byte received the bus master must not acknowledge the data.

After a subsequent restart, the command byte contains the value of the next register to be read in the pair. For example, if Input Port 1 was read last before the restart, the register that is read after the restart is the Input Port 0.

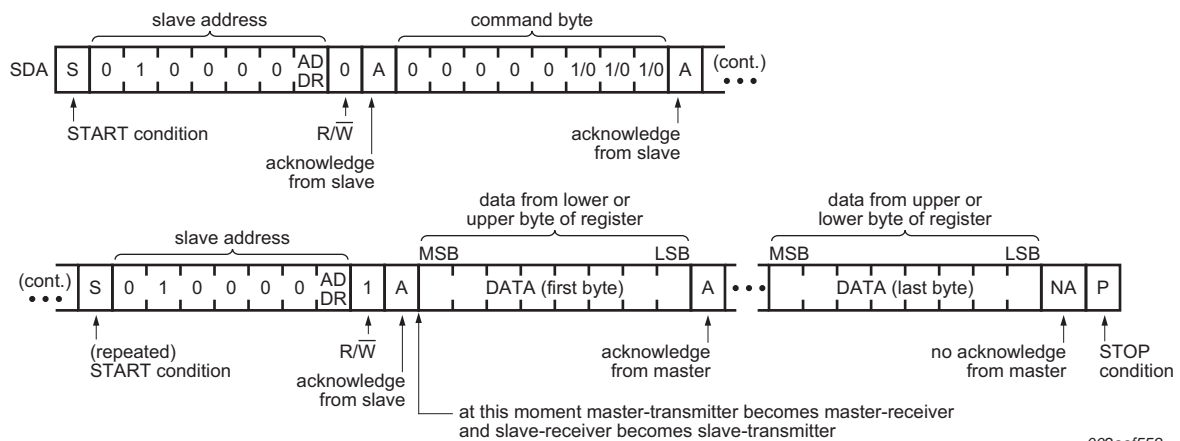
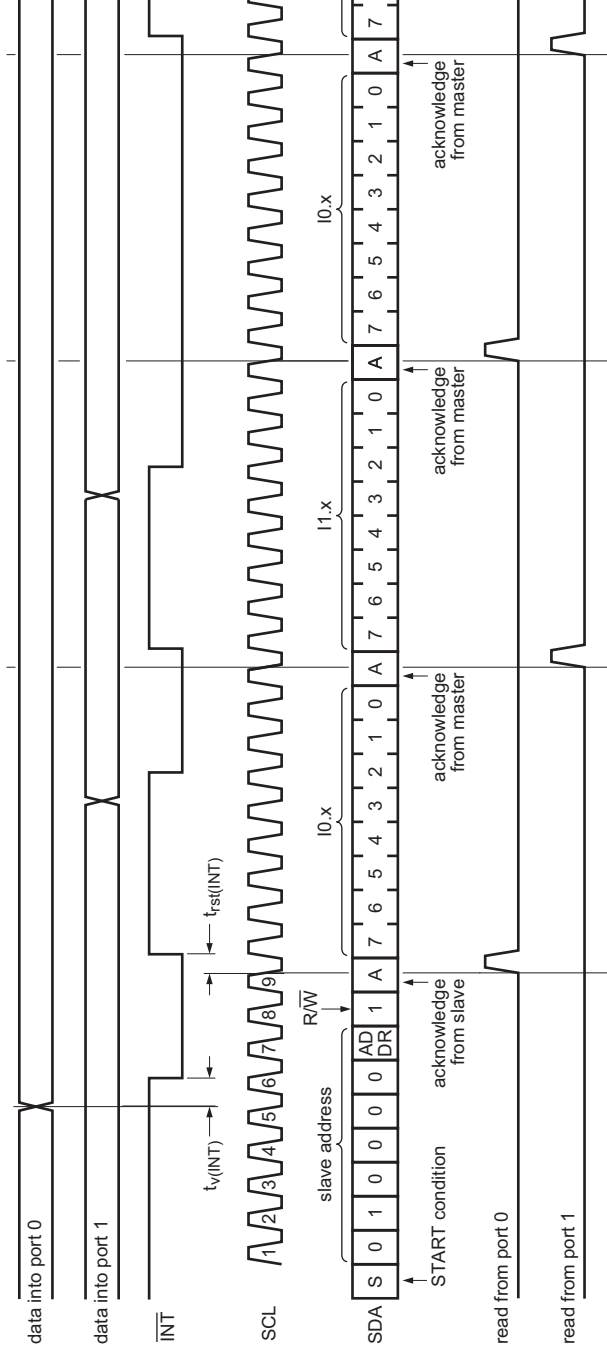

Fig 11. Read from device registers



Remark: Transfer of data can be stopped at any moment by a STOP condition. When this occurs, data present at the latest acknowledged byte is assumed that the command byte has previously been set to '00' (read input port register).

This figure eliminates the command byte transfer and a restart between the initial slave address call and actual data transfer from P port 0.

Fig 12. Read input port register, scenario 1

9. Application design-in information

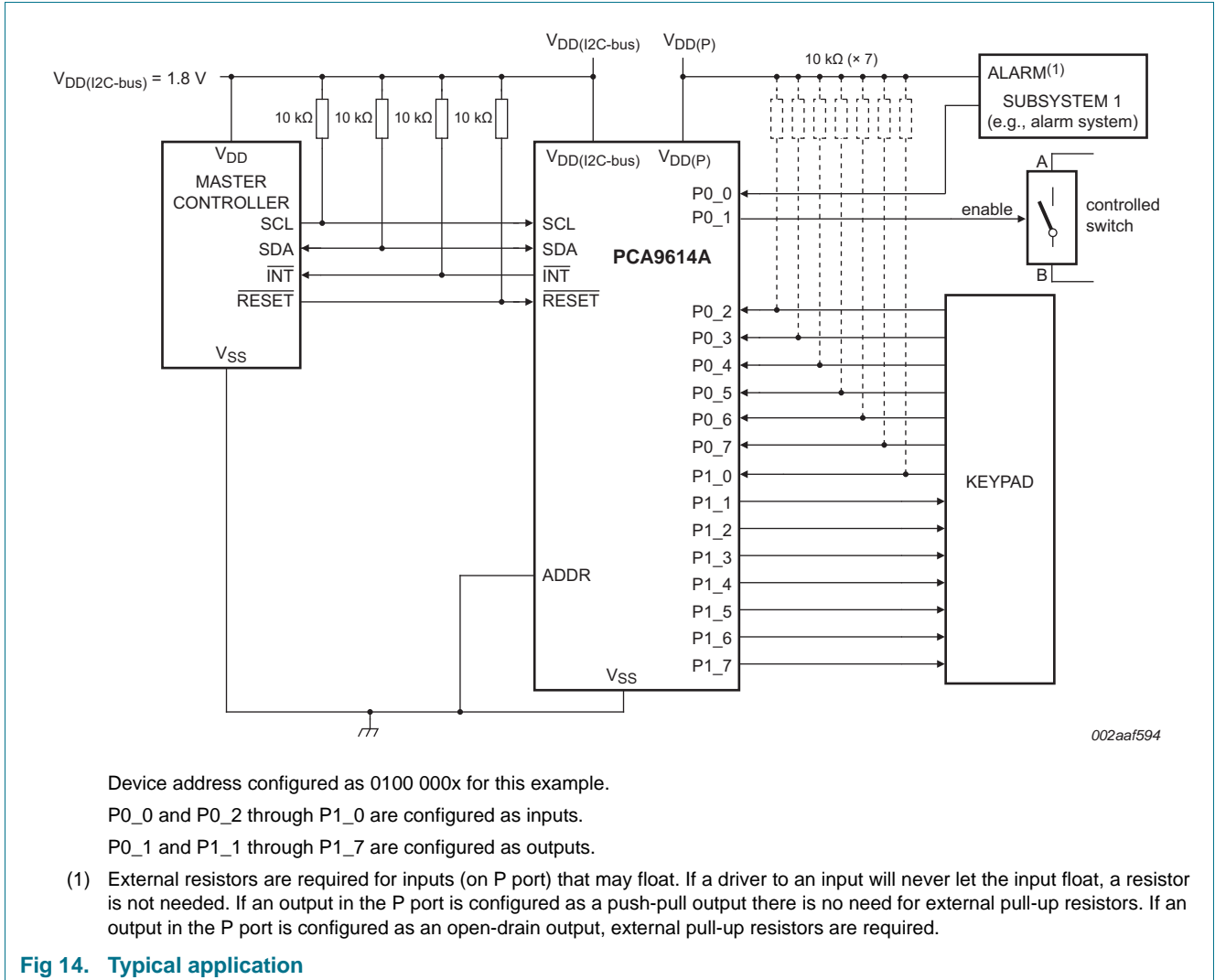

9.1 Minimizing I_{DD} when the I/Os are used to control LEDs

When the I/Os are used to control LEDs, they are normally connected to V_{DD(P)} through a resistor as shown in Figure 14. Since the LED acts as a diode, when the LED is off the I/O V_I is about 1.2 V less than V_{DD(P)}. The supply current, I_{DD(P)}, increases as V_I becomes lower than V_{DD(P)}.

Designs needing to minimize current consumption, such as battery power applications, should consider maintaining the I/O pins greater than or equal to V_{DD(P)} when the LED is off. Figure 15 shows a high value resistor in parallel with the LED. Figure 16 shows V_{DD(P)} less than the LED supply voltage by at least 1.2 V. Both of these methods maintain the I/O V_I at or above V_{DD(P)} and prevents additional supply current consumption when the LED is off.

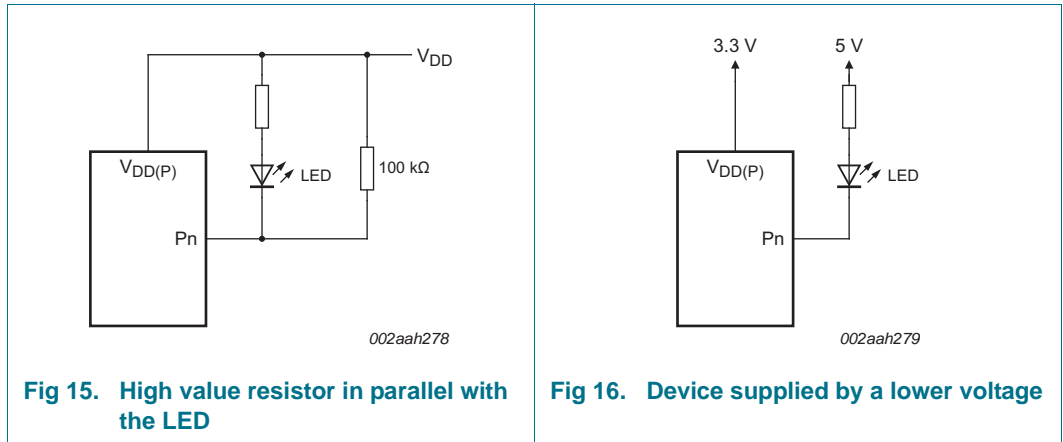

9.2 Power-on reset requirements

In the event of a glitch or data corruption, PCA6416A can be reset to its default conditions by using the power-on reset feature. Power-on reset requires that the device go through a power cycle to be completely reset. This reset also happens when the device is powered on for the first time in an application.

The two types of power-on reset are shown in [Figure 17](#) and [Figure 18](#).

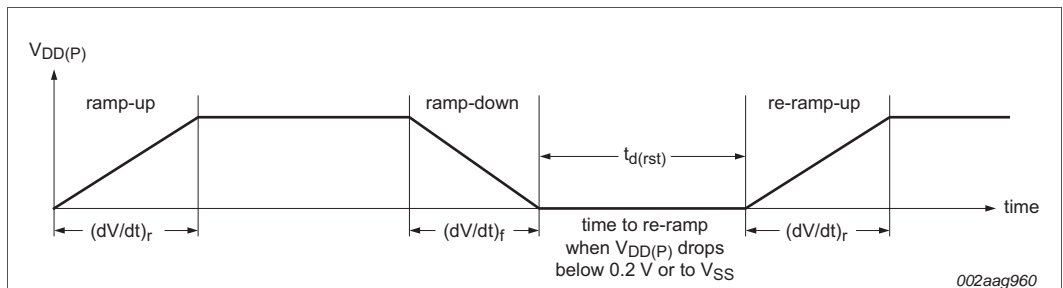

Fig 17. V_{DD(P)} is lowered below 0.2 V or to 0 V and then ramped up to V_{DD(P)}

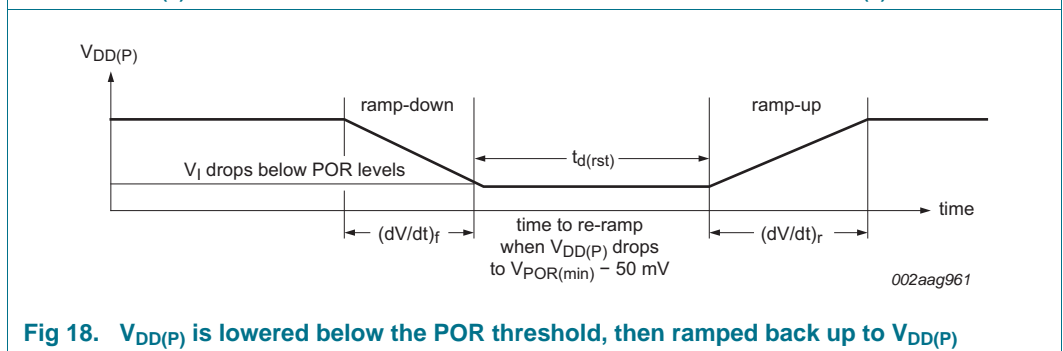

Fig 18. V_{DD(P)} is lowered below the POR threshold, then ramped back up to V_{DD(P)}

[Table 15](#) specifies the performance of the power-on reset feature for PCA6416A for both types of power-on reset.

Table 15. Recommended supply sequencing and ramp rates
T_{amb} = 25 °C (unless otherwise noted). Not tested; specified by design.

Symbol	Parameter	Condition	Min	Typ	Max	Unit
(dV/dt) _f	fall rate of change of voltage	Figure 17	0.1	-	2000	ms
(dV/dt) _r	rise rate of change of voltage	Figure 17	0.1	-	2000	ms
t _{d(rst)}	reset delay time	Figure 17 ; re-ramp time when V _{DD(P)} drops below 0.2 V or to V _{SS}	1	-	-	μs
		Figure 18 ; re-ramp time when V _{DD(P)} drops to V _{POR(min)} - 50 mV	1	-	-	μs
ΔV _{DD(gl)}	glitch supply voltage difference	Figure 19	[1]	-	1.0	V
t _{w(gl)VDD}	supply voltage glitch pulse width	Figure 19	[2]	-	10	μs
V _{POR(trip)}	power-on reset trip voltage	falling V _{DD(P)}	0.7	-	-	V
		rising V _{DD(P)}	-	-	1.4	V

- [1] Level that V_{DD(P)} can glitch down to with a ramp rate at 0.4 μs/V, but not cause a functional disruption when t_{w(gl)VDD} < 1 μs.
- [2] Glitch width that will not cause a functional disruption when ΔV_{DD(gl)} = 0.5 × V_{DD(P)}.

Glitches in the power supply can also affect the power-on reset performance of this device. The glitch width (t_{w(gl)VDD}) and glitch height (ΔV_{DD(gl)}) are dependent on each other. The bypass capacitance, source impedance, and device impedance are factors that affect power-on reset performance. [Figure 19](#) and [Table 15](#) provide more information on how to measure these specifications.

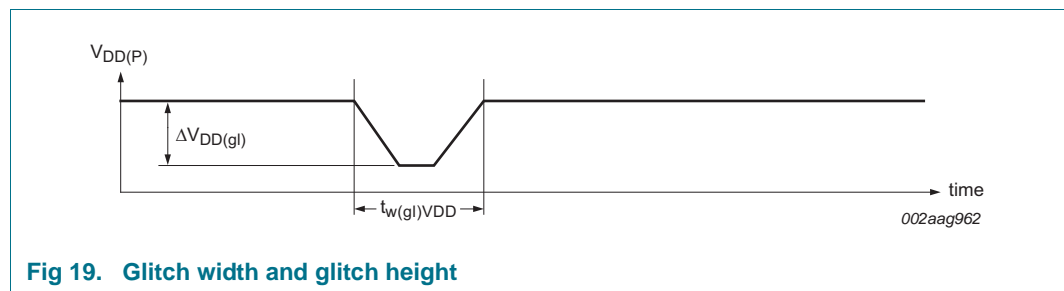

Fig 19. Glitch width and glitch height

V_{POR} is critical to the power-on reset. V_{POR} is the voltage level at which the reset condition is released and all the registers and the I²C-bus/SMBus state machine are initialized to their default states. The value of V_{POR} differs based on the V_{DD} being lowered to or from 0 V. [Figure 20](#) and [Table 15](#) provide more details on this specification.

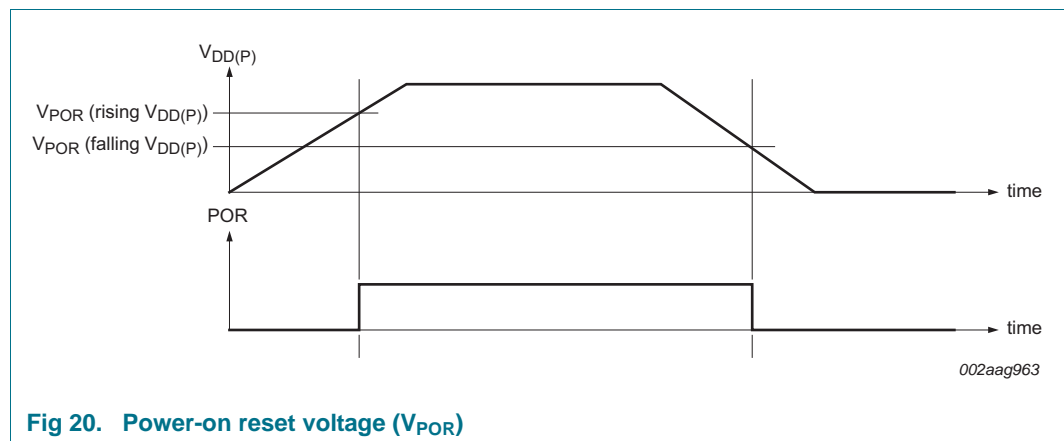

Fig 20. Power-on reset voltage (V_{POR})

10. Limiting values

Table 16. Limiting values
In accordance with the Absolute Maximum Rating System (IEC 60134).

Symbol	Parameter	Conditions	Min	Max	Unit
V _{DD(I2C-bus)}	I ² C-bus supply voltage		-0.5	+6.5	V
V _{DD(P)}	supply voltage port P		-0.5	+6.5	V
V _I	input voltage		[1] -0.5	+6.5	V
V _O	output voltage		[1] -0.5	+6.5	V
I _{IK}	input clamping current	ADDR, $\overline{\text{RESET}}$, SCL; V _I < 0 V	-	±20	mA
I _{OK}	output clamping current	$\overline{\text{INT}}$; V _O < 0 V	-	±20	mA
I _{IOK}	input/output clamping current	P port; V _O < 0 V or V _O > V _{DD(P)}	-	±20	mA
		SDA; V _O < 0 V or V _O > V _{DD(I2C-bus)}	-	±20	mA
I _{OL}	LOW-level output current	continuous; P port; V _O = 0 V to V _{DD(P)}	-	50	mA
		continuous; SDA, $\overline{\text{INT}}$; V _O = 0 V to V _{DD(I2C-bus)}	-	25	mA
I _{OH}	HIGH-level output current	continuous; P port; V _O = 0 V to V _{DD(P)}	-	25	mA
I _{DD}	supply current	continuous through V _{SS}	-	200	mA
I _{DD(P)}	supply current port P	continuous through V _{DD(P)}	-	160	mA
I _{DD(I2C-bus)}	I ² C-bus supply current	continuous through V _{DD(I2C-bus)}	-	10	mA
T _{stg}	storage temperature		-65	+150	°C
T _{j(max)}	maximum junction temperature		-	125	°C

[1] The input negative-voltage and output voltage ratings may be exceeded if the input and output current ratings are observed.

11. Recommended operating conditions

Table 17. Operating conditions

Symbol	Parameter	Conditions	Min	Max	Unit
V _{DD(I2C-bus)}	I ² C-bus supply voltage		1.65	5.5	V
V _{DD(P)}	supply voltage port P		1.65	5.5	V
V _{IH}	HIGH-level input voltage	SCL, SDA, $\overline{\text{RESET}}$	0.7 × V _{DD(I2C-bus)}	5.5	V
		ADDR, P1_7 to P0_0	0.7 × V _{DD(P)}	5.5	V
V _{IL}	LOW-level input voltage	SCL, SDA, $\overline{\text{RESET}}$	-0.5	0.3 × V _{DD(I2C-bus)}	V
		ADDR, P1_7 to P0_0	-0.5	0.3 × V _{DD(P)}	V
I _{OH}	HIGH-level output current	P1_7 to P0_0	-	10	mA
I _{OL}	LOW-level output current	P1_7 to P0_0	-	25	mA
T _{amb}	ambient temperature	operating in free air	-40	+85	°C

12. Thermal characteristics

Table 18. Thermal characteristics

Symbol	Parameter	Conditions	Max	Unit
$Z_{th(j-a)}$	transient thermal impedance from junction to ambient	TSSOP24 package	[1] 88	K/W
		HWQFN24 package	[1] 66	K/W
		VFBGA24 package	[1] 171	K/W

[1] The package thermal impedance is calculated in accordance with JESD 51-7.

13. Static characteristics

Table 19. Static characteristics

$T_{amb} = -40\text{ °C to }+85\text{ °C}$; $V_{DD(I2C-bus)} = 1.65\text{ V to }5.5\text{ V}$; unless otherwise specified.

Symbol	Parameter	Conditions	Min	Typ ^[1]	Max	Unit
V_{IK}	input clamping voltage	$I_I = -18\text{ mA}$	-1.2	-	-	V
V_{POR}	power-on reset voltage	$V_I = V_{DD(P)}$ or V_{SS} ; $I_O = 0\text{ mA}$	-	1.1	1.4	V
V_{OH}	HIGH-level output voltage	P port				
		$I_{OH} = -8\text{ mA}$; $V_{DD(P)} = 1.65\text{ V}$	[2] 1.2	-	-	V
		$I_{OH} = -10\text{ mA}$; $V_{DD(P)} = 1.65\text{ V}$	[2] 1.1	-	-	V
		$I_{OH} = -8\text{ mA}$; $V_{DD(P)} = 2.3\text{ V}$	[2] 1.8	-	-	V
		$I_{OH} = -10\text{ mA}$; $V_{DD(P)} = 2.3\text{ V}$	[2] 1.7	-	-	V
		$I_{OH} = -8\text{ mA}$; $V_{DD(P)} = 3.0\text{ V}$	[2] 2.6	-	-	V
		$I_{OH} = -10\text{ mA}$; $V_{DD(P)} = 3.0\text{ V}$	[2] 2.5	-	-	V
		$I_{OH} = -8\text{ mA}$; $V_{DD(P)} = 4.5\text{ V}$	[2] 4.1	-	-	V
V_{OL}	LOW-level output voltage	P port; $I_{OL} = 8\text{ mA}$				
		$V_{DD(P)} = 1.65\text{ V}$	[2] -	-	0.45	V
		$V_{DD(P)} = 2.3\text{ V}$	[2] -	-	0.25	V
		$V_{DD(P)} = 3\text{ V}$	[2] -	-	0.25	V
I_{OL}	LOW-level output current	$V_{OL} = 0.4\text{ V}$; $V_{DD(P)} = 1.65\text{ V to }5.5\text{ V}$				
		SDA	[3] 3	-	-	mA
		\overline{INT}	[3] 3	15 ^[4]	-	mA
		P port				
		$V_{OL} = 0.5\text{ V}$; $V_{DD(P)} = 1.65\text{ V}$	[3] 8	10	-	mA
		$V_{OL} = 0.7\text{ V}$; $V_{DD(P)} = 1.65\text{ V}$	[3] 10	13	-	mA
		$V_{OL} = 0.5\text{ V}$; $V_{DD(P)} = 2.3\text{ V}$	[3] 8	10	-	mA
		$V_{OL} = 0.7\text{ V}$; $V_{DD(P)} = 2.3\text{ V}$	[3] 10	13	-	mA
		$V_{OL} = 0.5\text{ V}$; $V_{DD(P)} = 3.0\text{ V}$	[3] 8	14	-	mA
		$V_{OL} = 0.7\text{ V}$; $V_{DD(P)} = 3.0\text{ V}$	[3] 10	19	-	mA
		$V_{OL} = 0.5\text{ V}$; $V_{DD(P)} = 4.5\text{ V}$	[3] 8	17	-	mA
$V_{OL} = 0.7\text{ V}$; $V_{DD(P)} = 4.5\text{ V}$	[3] 10	24	-	mA		

Table 19. Static characteristics ...continued

$T_{amb} = -40\text{ }^{\circ}\text{C}$ to $+85\text{ }^{\circ}\text{C}$; $V_{DD(I2C-bus)} = 1.65\text{ V}$ to 5.5 V ; unless otherwise specified.

Symbol	Parameter	Conditions	Min	Typ ^[1]	Max	Unit	
I_I	input current	$V_{DD(P)} = 1.65\text{ V}$ to 5.5 V SCL, SDA, $\overline{\text{RESET}}$; $V_I = V_{DD(I2C-bus)}$ or V_{SS}	-	-	± 1	μA	
		ADDR; $V_I = V_{DD(P)}$ or V_{SS}	-	-	± 1	μA	
I_{IH}	HIGH-level input current	P port; $V_I = V_{DD(P)}$; $V_{DD(P)} = 1.65\text{ V}$ to 5.5 V	-	-	1	μA	
I_{IL}	LOW-level input current	P port; $V_I = V_{SS}$; $V_{DD(P)} = 1.65\text{ V}$ to 5.5 V	-	-	1	μA	
I_{DD}	supply current	$I_{DD(I2C-bus)} + I_{DD(P)}$; SDA, P port, ADDR, $\overline{\text{RESET}}$; V_I on SDA and $\overline{\text{RESET}} = V_{DD(I2C-bus)}$ or V_{SS} ; V_I on P port and ADDR = $V_{DD(P)}$; $I_O = 0\text{ mA}$; I/O = inputs; $f_{SCL} = 400\text{ kHz}$	-	10	25	μA	
		$V_{DD(P)} = 3.6\text{ V}$ to 5.5 V	-	6.5	15	μA	
		$V_{DD(P)} = 2.3\text{ V}$ to 3.6 V	-	4	9	μA	
		$V_{DD(P)} = 1.65\text{ V}$ to 2.3 V	-	-	-	-	-
		$I_{DD(I2C-bus)} + I_{DD(P)}$; SCL, SDA, P port, ADDR, $\overline{\text{RESET}}$; V_I on SCL, SDA and $\overline{\text{RESET}} = V_{DD(I2C-bus)}$ or V_{SS} ; V_I on P port and ADDR = $V_{DD(P)}$; $I_O = 0\text{ mA}$; I/O = inputs; $f_{SCL} = 0\text{ kHz}$	-	1.5	7	μA	
		$V_{DD(P)} = 3.6\text{ V}$ to 5.5 V	-	1	3.2	μA	
		$V_{DD(P)} = 2.3\text{ V}$ to 3.6 V	-	0.5	1.7	μA	
		$V_{DD(P)} = 1.65\text{ V}$ to 2.3 V	-	-	-	-	-
		Active mode; $I_{DD(I2C-bus)} + I_{DD(P)}$; P port, ADDR, $\overline{\text{RESET}}$; V_I on $\overline{\text{RESET}} = V_{DD(I2C-bus)}$; V_I on P port and ADDR = $V_{DD(P)}$; $I_O = 0\text{ mA}$; I/O = inputs; $f_{SCL} = 400\text{ kHz}$, continuous register read	-	60	125	μA	
		$V_{DD(P)} = 3.6\text{ V}$ to 5.5 V	-	40	75	μA	
$V_{DD(P)} = 2.3\text{ V}$ to 3.6 V	-	20	45	μA			
$V_{DD(P)} = 1.65\text{ V}$ to 2.3 V	-	-	-	-	-		
ΔI_{DD}	additional quiescent supply current	SCL, SDA, $\overline{\text{RESET}}$; one input at $V_{DD(I2C-bus)} - 0.6\text{ V}$, other inputs at $V_{DD(I2C-bus)}$ or V_{SS} ; $V_{DD(P)} = 1.65\text{ V}$ to 5.5 V	-	-	25	μA	
		P port, ADDR; one input at $V_{DD(P)} - 0.6\text{ V}$, other inputs at $V_{DD(P)}$ or V_{SS} ; $V_{DD(P)} = 1.65\text{ V}$ to 5.5 V	-	-	80	μA	
C_i	input capacitance	$V_I = V_{DD(I2C-bus)}$ or V_{SS} ; $V_{DD(P)} = 1.65\text{ V}$ to 5.5 V	-	6	7	pF	
C_{iO}	input/output capacitance	$V_{I/O} = V_{DD(I2C-bus)}$ or V_{SS} ; $V_{DD(P)} = 1.65\text{ V}$ to 5.5 V	-	7	8	pF	
		$V_{I/O} = V_{DD(P)}$ or V_{SS} ; $V_{DD(P)} = 1.65\text{ V}$ to 5.5 V	-	7.5	8.5	pF	

[1] For I_{DD} , all typical values are at nominal supply voltage (1.8 V, 2.5 V, 3.3 V, 3.6 V or 5 V V_{DD}) and $T_{amb} = 25\text{ }^{\circ}\text{C}$. Except for I_{DD} , the typical values are at $V_{DD(P)} = V_{DD(I2C-bus)} = 3.3\text{ V}$ and $T_{amb} = 25\text{ }^{\circ}\text{C}$.

[2] The total current sourced by all I/Os must be limited to 160 mA.

[3] Each I/O must be externally limited to a maximum of 25 mA, for a device total of 200 mA.

[4] Typical value for $T_{amb} = 25\text{ }^{\circ}\text{C}$. $V_{OL} = 0.4\text{ V}$ and $V_{DD} = 3.3\text{ V}$. Typical value for $V_{DD} < 2.5\text{ V}$, $V_{OL} = 0.6\text{ V}$.

13.1 Typical characteristics

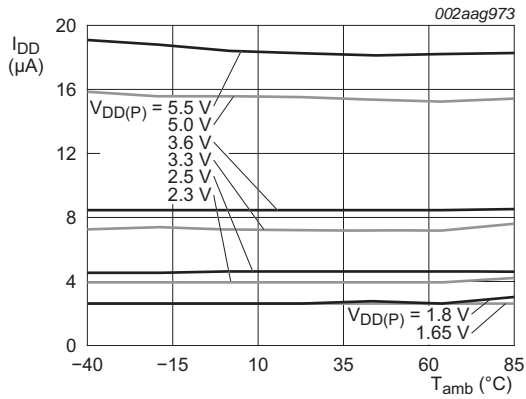

$$I_{DD} = I_{DD(I2C-bus)} + I_{DD(P)}$$

Fig 21. Supply current versus ambient temperature

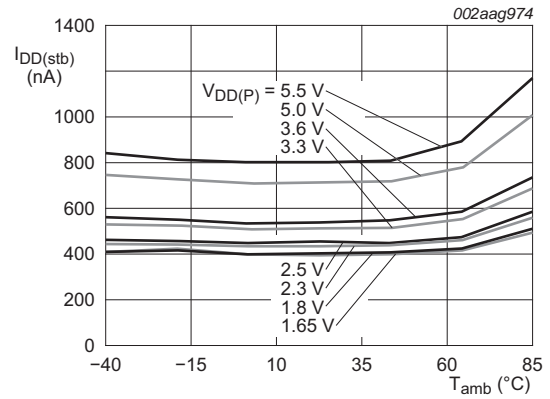
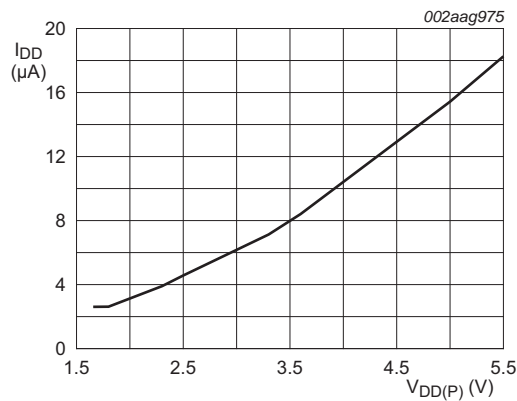

Fig 22. Standby supply current versus ambient temperature



T_{amb} = 25 °C

$$I_{DD} = I_{DD(I2C-bus)} + I_{DD(P)}$$

Fig 23. Supply current versus supply voltage

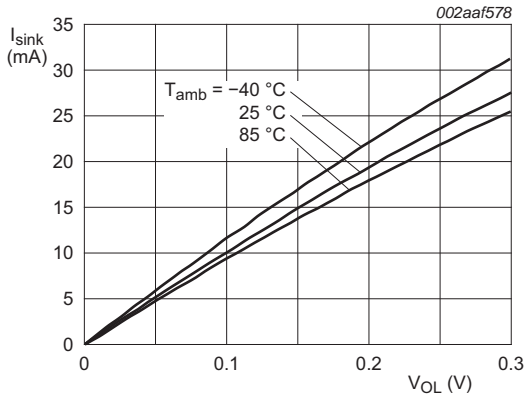

a. $V_{DD(P)} = 1.65 \text{ V}$

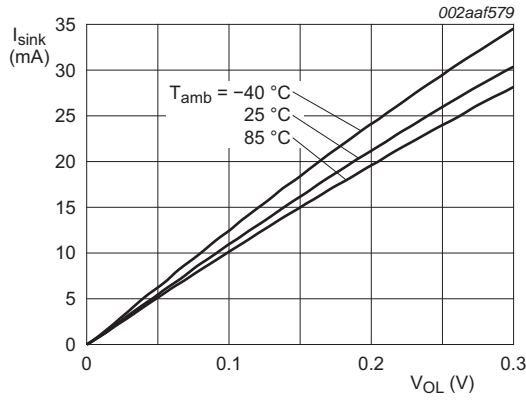

b. $V_{DD(P)} = 1.8 \text{ V}$

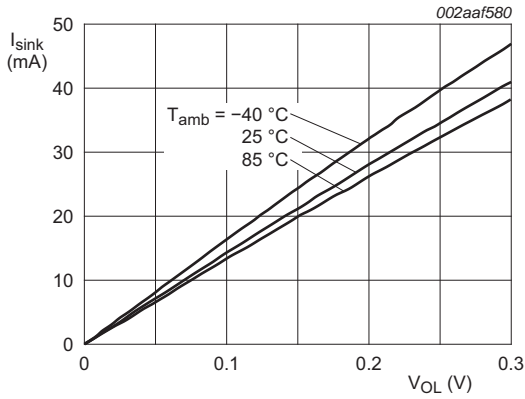

c. $V_{DD(P)} = 2.5 \text{ V}$

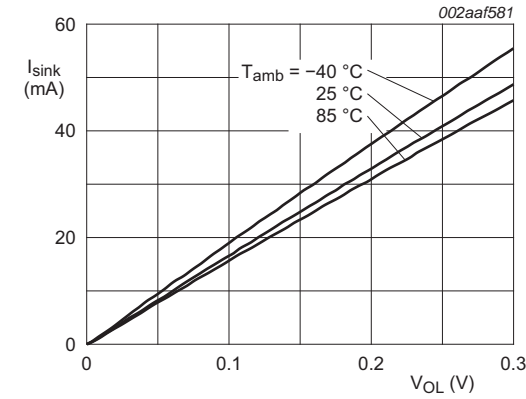

d. $V_{DD(P)} = 3.3 \text{ V}$

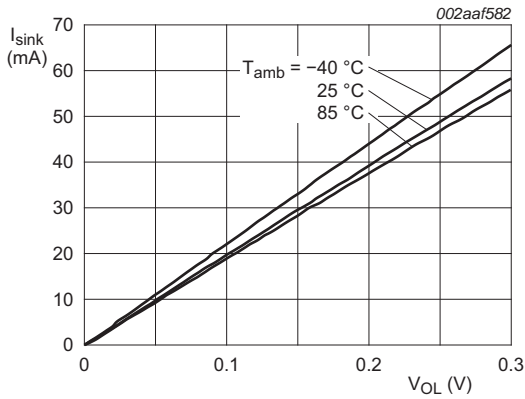

e. $V_{DD(P)} = 5.0 \text{ V}$

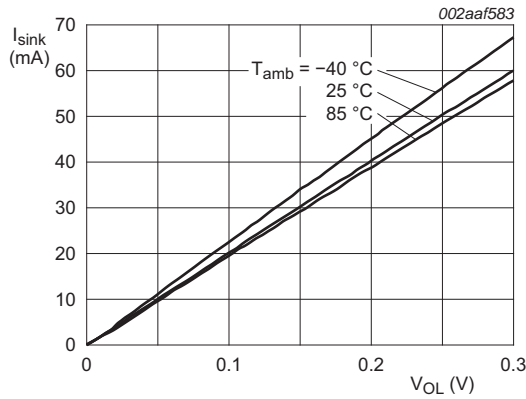

f. $V_{DD(P)} = 5.5 \text{ V}$

Fig 24. I/O sink current versus LOW-level output voltage

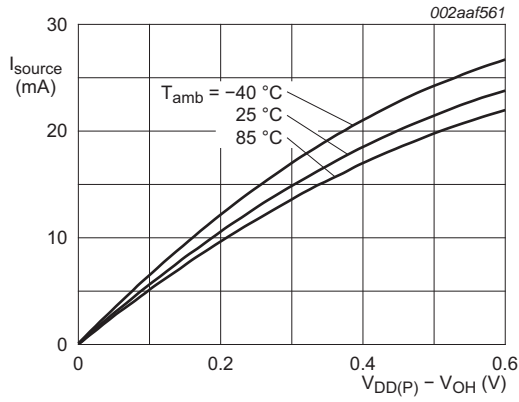

a. $V_{DD(P)} = 1.65 \text{ V}$

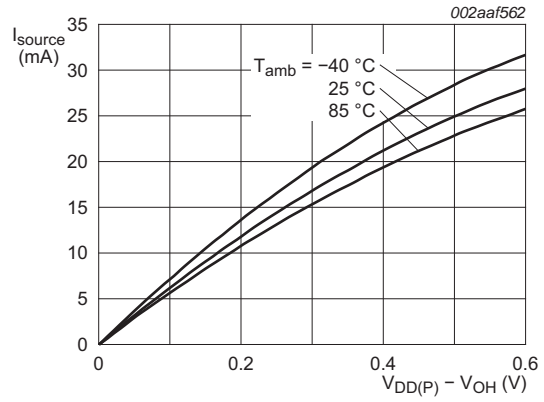

b. $V_{DD(P)} = 1.8 \text{ V}$

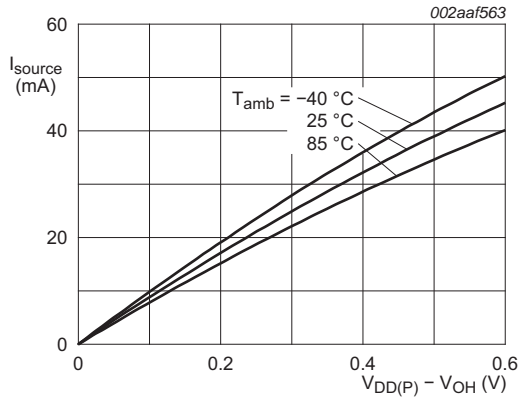

c. $V_{DD(P)} = 2.5 \text{ V}$

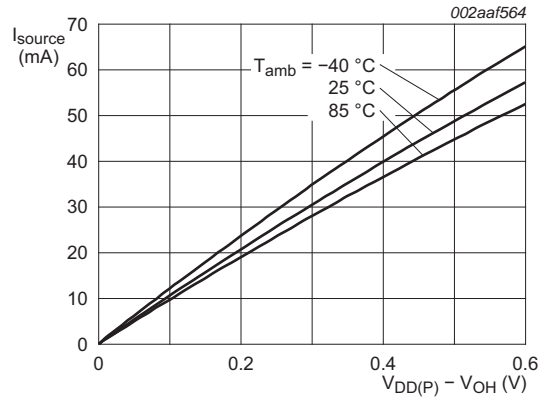

d. $V_{DD(P)} = 3.3 \text{ V}$

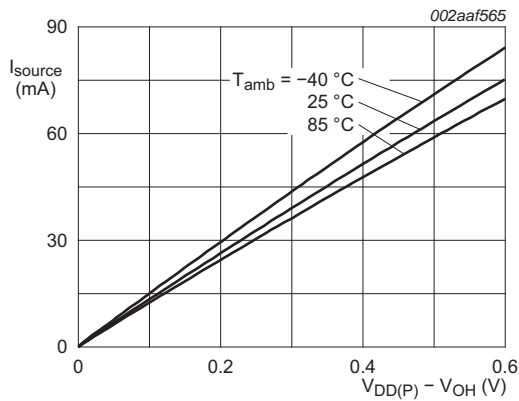

e. $V_{DD(P)} = 5.0 \text{ V}$

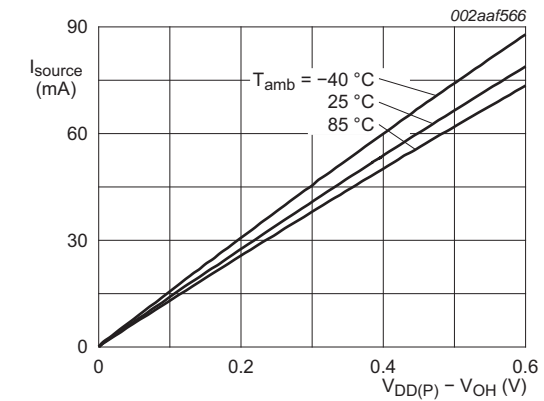

f. $V_{DD(P)} = 5.5 \text{ V}$

Fig 25. I/O source current versus HIGH-level output voltage

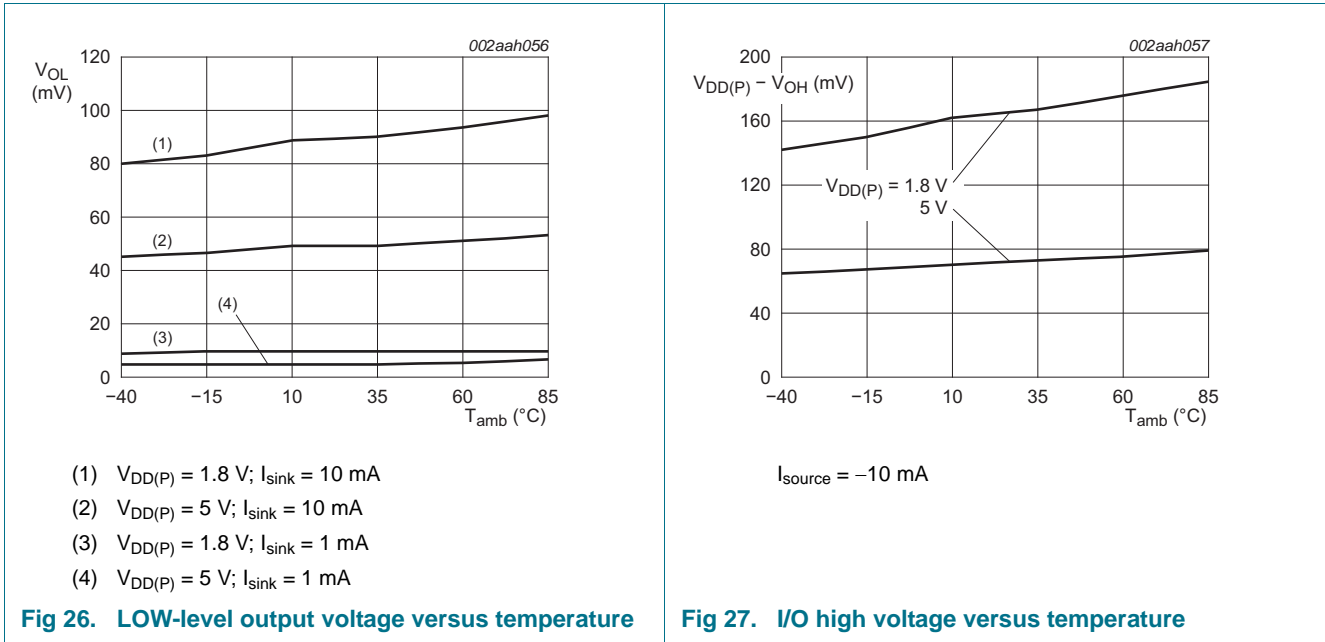

14. Dynamic characteristics

Table 20. I²C-bus interface timing requirements

Over recommended operating free air temperature range, unless otherwise specified. See [Figure 29](#).

Symbol	Parameter	Conditions	Standard-mode I ² C-bus		Fast-mode I ² C-bus		Unit
			Min	Max	Min	Max	
f _{SCL}	SCL clock frequency		0	100	0	400	kHz
t _{HIGH}	HIGH period of the SCL clock		4	-	0.6	-	μs
t _{LOW}	LOW period of the SCL clock		4.7	-	1.3	-	μs
t _{SP}	pulse width of spikes that must be suppressed by the input filter		0	50	0	50	ns
t _{SU;DAT}	data set-up time		250	-	100	-	ns
t _{HD;DAT}	data hold time		0	-	0	-	ns
t _r	rise time of both SDA and SCL signals		-	1000	20	300	ns
t _f	fall time of both SDA and SCL signals		-	300	20 × (V _{DD} / 5.5 V)	300	ns
t _{BUF}	bus free time between a STOP and START condition		4.7	-	1.3	-	μs
t _{SU;STA}	set-up time for a repeated START condition		4.7	-	0.6	-	μs
t _{HD;STA}	hold time (repeated) START condition		4	-	0.6	-	μs
t _{SU;STO}	set-up time for STOP condition		4	-	0.6	-	μs
t _{VD;DAT}	data valid time	SCL LOW to SDA output valid	-	3.45	-	0.9	μs
t _{VD;ACK}	data valid acknowledge time	ACK signal from SCL LOW to SDA (out) LOW	-	3.45	-	0.9	μs

Table 21. Reset timing requirements

Over recommended operating free air temperature range, unless otherwise specified. See [Figure 31](#).

Symbol	Parameter	Conditions	Standard-mode I ² C-bus		Fast-mode I ² C-bus		Unit
			Min	Max	Min	Max	
t _{w(rst)}	reset pulse width		30	-	30	-	ns
t _{rec(rst)}	reset recovery time		200	-	200	-	ns
t _{rst}	reset time	[1]	600	-	600	-	ns

[1] Minimum time for SDA to become HIGH or minimum time to wait before doing a START.

Table 22. Switching characteristics

Over recommended operating free air temperature range; $C_L \leq 100$ pF; unless otherwise specified. See [Figure 30](#).

Symbol	Parameter	Conditions	Standard-mode I ² C-bus		Fast-mode I ² C-bus		Unit
			Min	Max	Min	Max	
$t_{V(INT)}$	valid time on pin \overline{INT}	from P port to \overline{INT}	-	1	-	1	μ s
$t_{rst(INT)}$	reset time on pin \overline{INT}	from SCL to \overline{INT}	-	1	-	1	μ s
$t_{V(Q)}$	data output valid time	from SCL to P port	-	400	-	400	ns
$t_{su(D)}$	data input set-up time	from P port to SCL	0	-	0	-	ns
$t_h(D)$	data input hold time	from P port to SCL	300	-	300	-	ns

15. Parameter measurement information

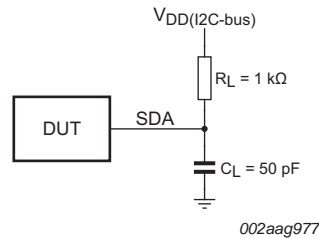

a. SDA load configuration

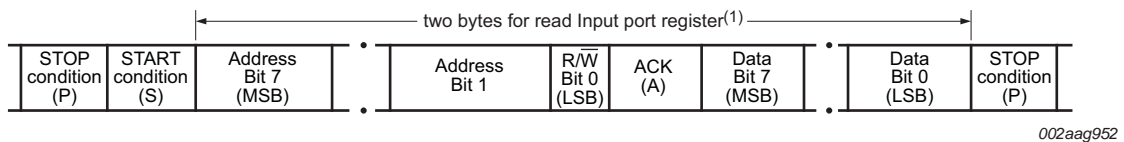

b. Transaction format

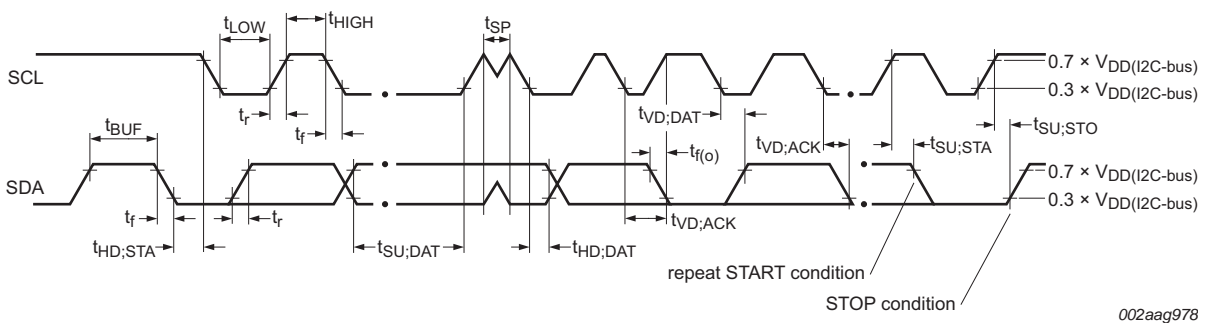

c. Voltage waveforms

C_L includes probe and jig capacitance.

All inputs are supplied by generators having the following characteristics: PRR \leq 10 MHz; $Z_o = 50 \Omega$; $t_r/t_f \leq 30$ ns.

All parameters and waveforms are not applicable to all devices.

Byte 1 = I²C-bus address; Byte 2, byte 3 = P port data.

(1) See [Figure 12](#).

Fig 28. I²C-bus interface load circuit and voltage waveforms

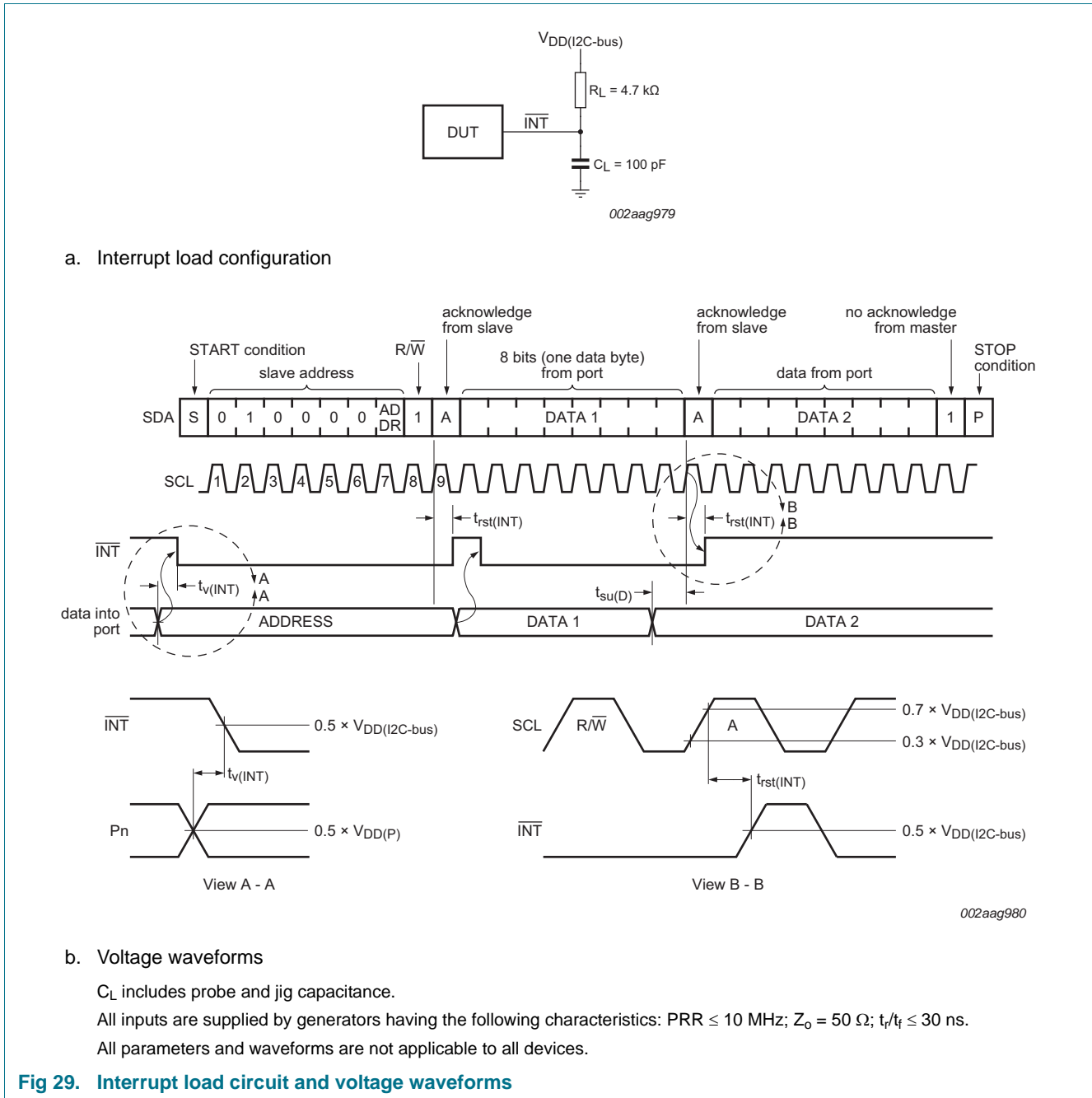

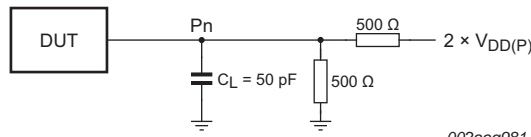

002aag981

a. P port load configuration

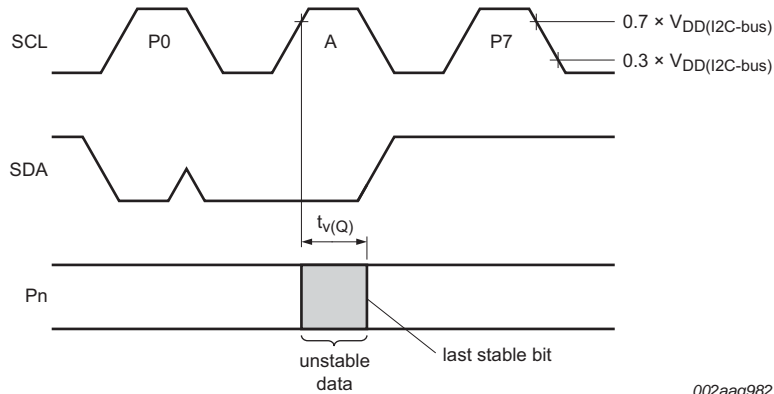

002aag982

b. Write mode ($\overline{R/\overline{W}} = 0$)

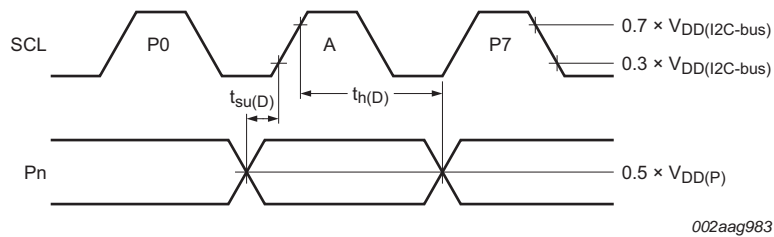

002aag983

c. Read mode ($\overline{R/\overline{W}} = 1$)

C_L includes probe and jig capacitance.

$t_{V(Q)}$ is measured from $0.7 \times V_{DD(I2C-bus)}$ on SCL to 50 % I/O (Pn) output.

All inputs are supplied by generators having the following characteristics: PRR \leq 10 MHz; $Z_o = 50 \Omega$; $t_r/t_f \leq 30$ ns.

The outputs are measured one at a time, with one transition per measurement.

All parameters and waveforms are not applicable to all devices.

Fig 30. P port load circuit and voltage waveforms

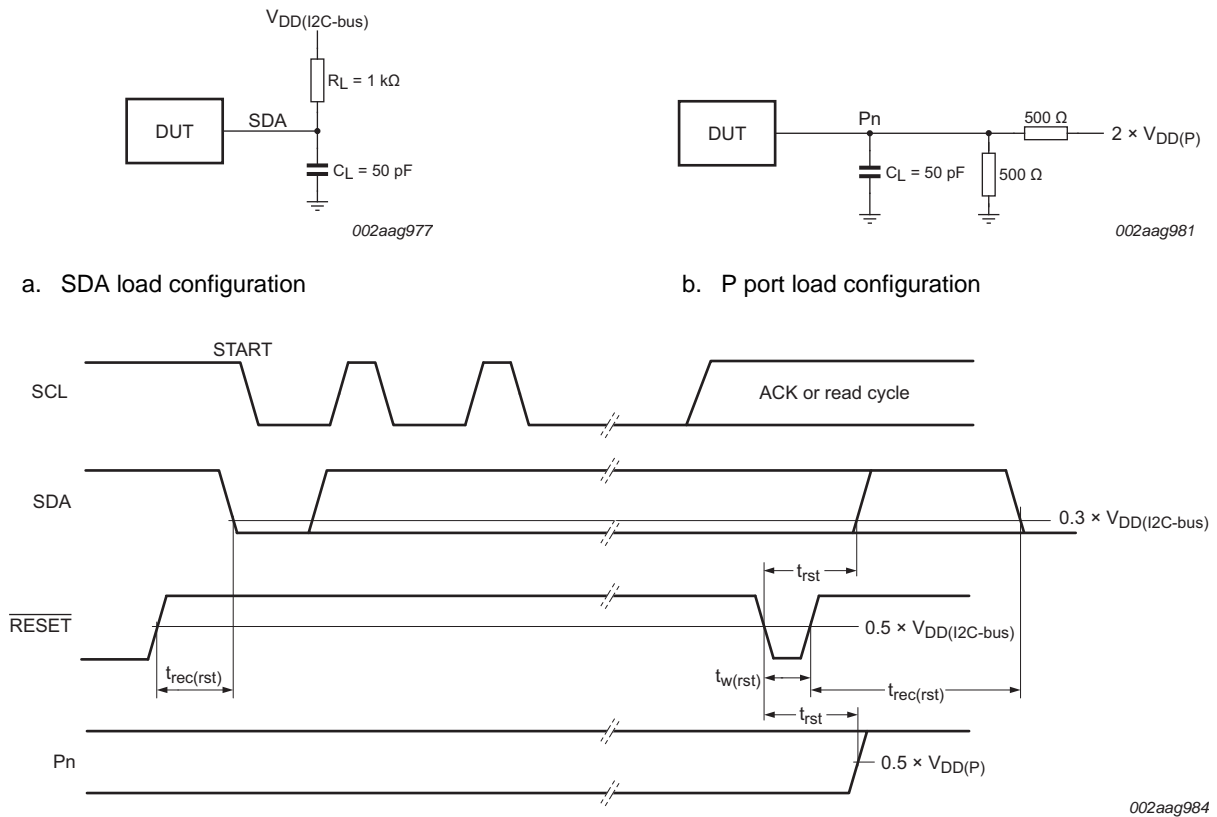

c. RESET timing

C_L includes probe and jig capacitance.

All inputs are supplied by generators having the following characteristics: $PRR \leq 10$ MHz; $Z_o = 50 \Omega$; $t_r/t_f \leq 30$ ns.

The outputs are measured one at a time, with one transition per measurement.

I/Os are configured as inputs.

All parameters and waveforms are not applicable to all devices.

Fig 31. Reset load circuits and voltage waveforms

16. Package outline

HWQFN24: plastic thermal enhanced very very thin quad flat package; no leads; 24 terminals; body 4 x 4 x 0.75 mm

SOT994-1

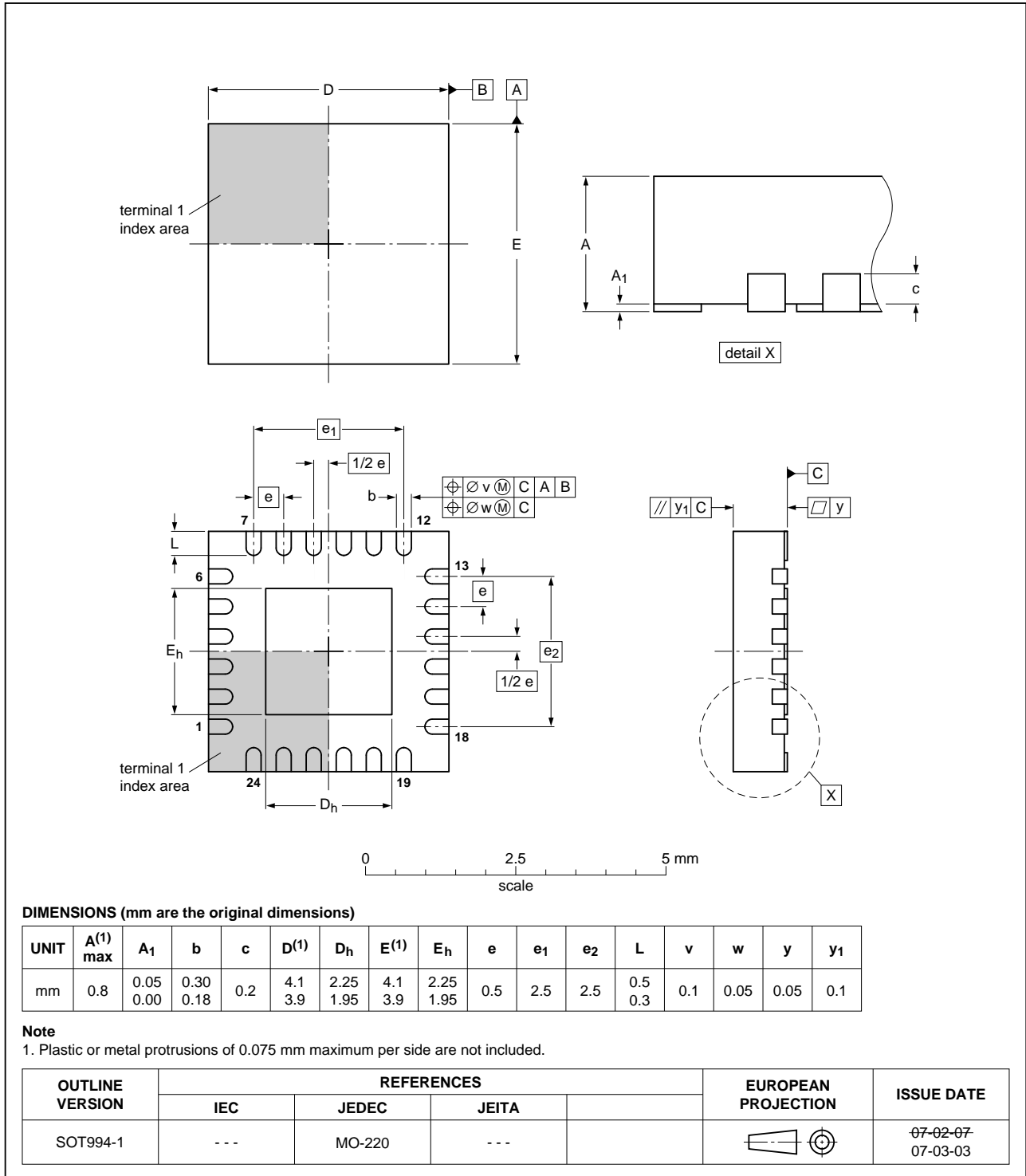

Fig 32. Package outline SOT994-1 (HWQFN24)

TSSOP24: plastic thin shrink small outline package; 24 leads; body width 4.4 mm

SOT355-1

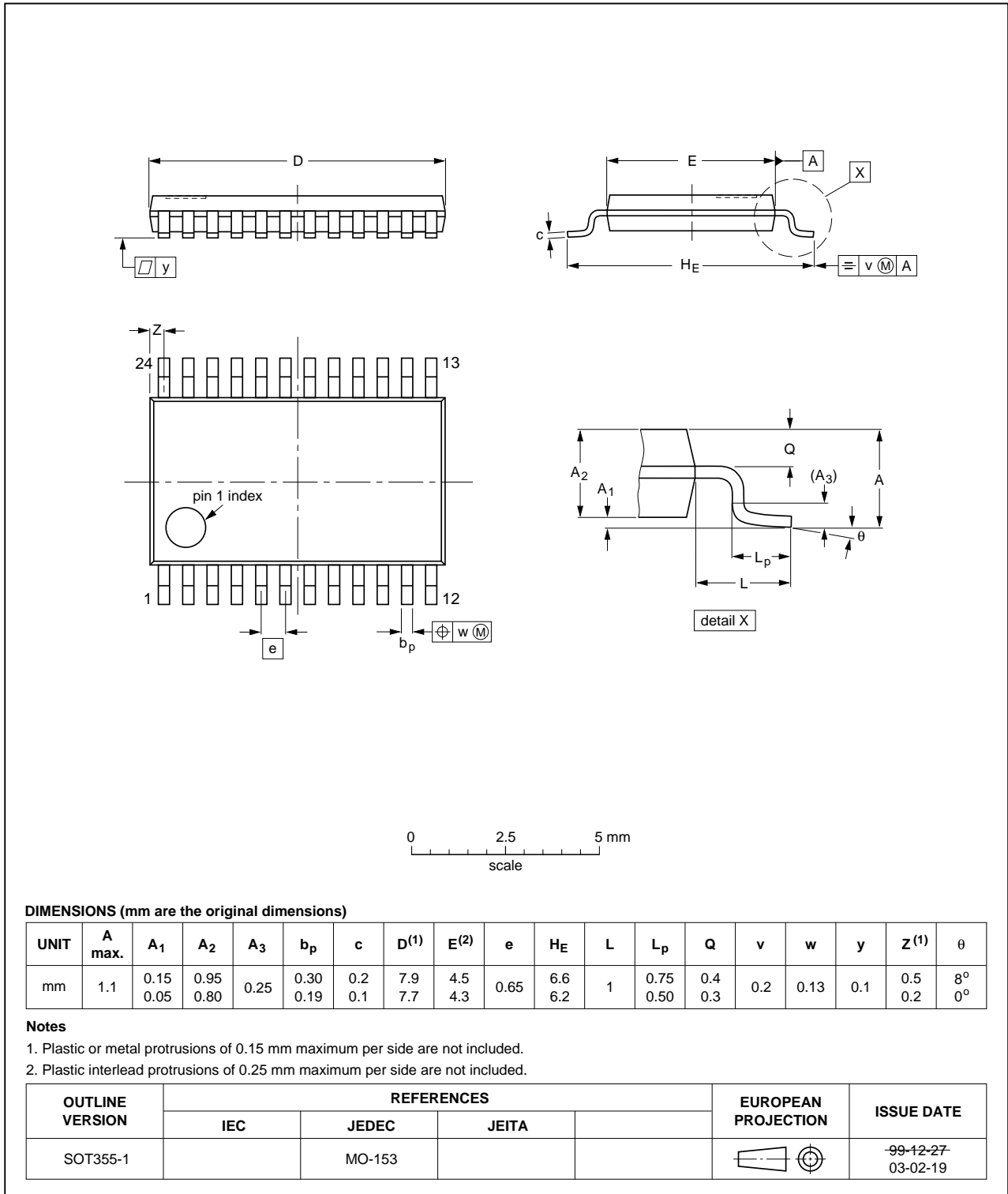

Fig 33. Package outline SOT355-1 (TSSOP24)

VFBGA24: plastic very thin fine-pitch ball grid array package;
24 balls; body 3 x 3 x 0.85 mm

SOT1199-1

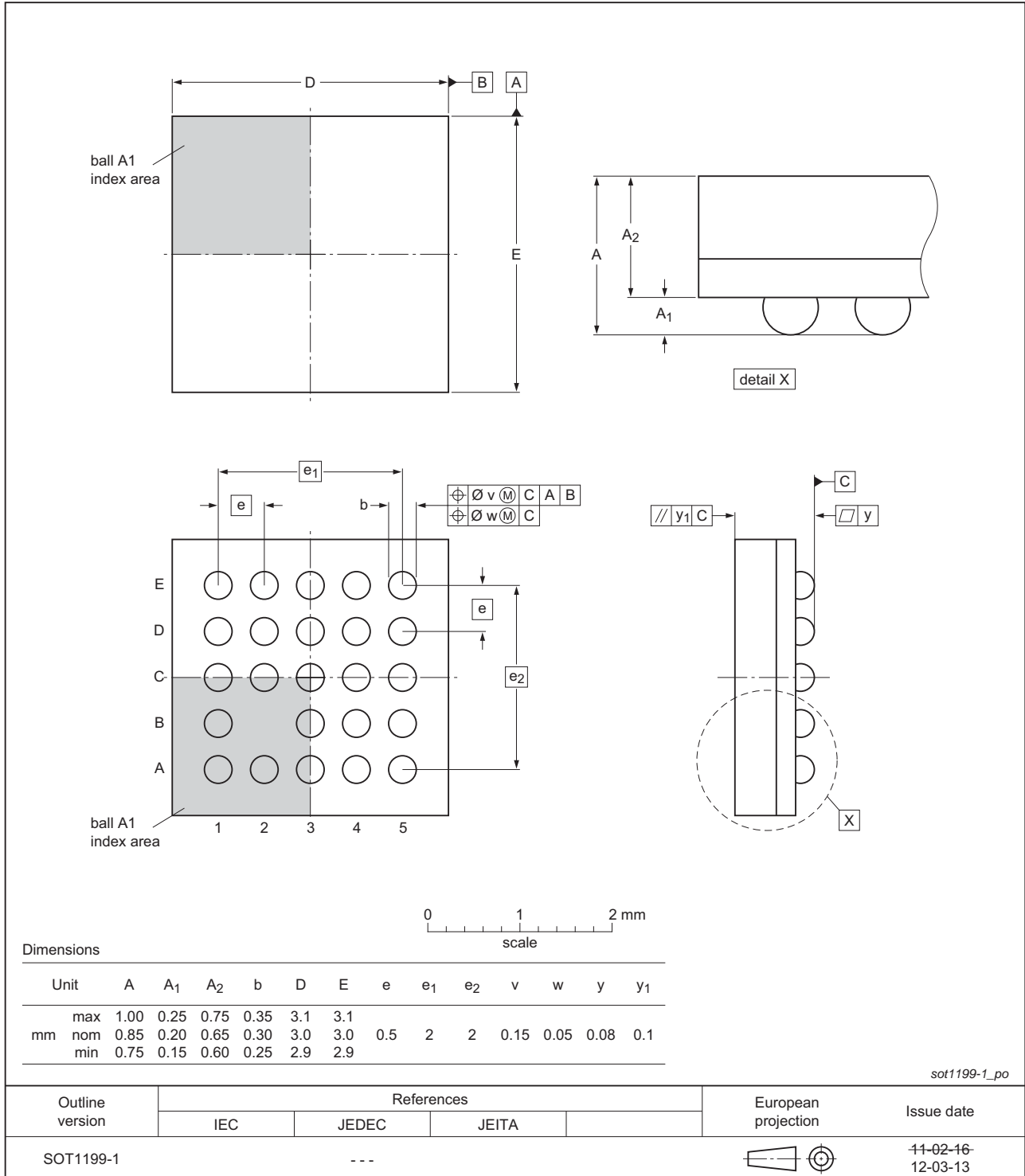

Fig 34. Package outline SOT1199-1 (VFBGA24)

17. Soldering of SMD packages

This text provides a very brief insight into a complex technology. A more in-depth account of soldering ICs can be found in Application Note AN10365 “Surface mount reflow soldering description”.

17.1 Introduction to soldering

Soldering is one of the most common methods through which packages are attached to Printed Circuit Boards (PCBs), to form electrical circuits. The soldered joint provides both the mechanical and the electrical connection. There is no single soldering method that is ideal for all IC packages. Wave soldering is often preferred when through-hole and Surface Mount Devices (SMDs) are mixed on one printed wiring board; however, it is not suitable for fine pitch SMDs. Reflow soldering is ideal for the small pitches and high densities that come with increased miniaturization.

17.2 Wave and reflow soldering

Wave soldering is a joining technology in which the joints are made by solder coming from a standing wave of liquid solder. The wave soldering process is suitable for the following:

- Through-hole components
- Leaded or leadless SMDs, which are glued to the surface of the printed circuit board

Not all SMDs can be wave soldered. Packages with solder balls, and some leadless packages which have solder lands underneath the body, cannot be wave soldered. Also, leaded SMDs with leads having a pitch smaller than ~0.6 mm cannot be wave soldered, due to an increased probability of bridging.

The reflow soldering process involves applying solder paste to a board, followed by component placement and exposure to a temperature profile. Leaded packages, packages with solder balls, and leadless packages are all reflow solderable.

Key characteristics in both wave and reflow soldering are:

- Board specifications, including the board finish, solder masks and vias
- Package footprints, including solder thieves and orientation
- The moisture sensitivity level of the packages
- Package placement
- Inspection and repair
- Lead-free soldering versus SnPb soldering

17.3 Wave soldering

Key characteristics in wave soldering are:

- Process issues, such as application of adhesive and flux, clinching of leads, board transport, the solder wave parameters, and the time during which components are exposed to the wave
- Solder bath specifications, including temperature and impurities

17.4 Reflow soldering

Key characteristics in reflow soldering are:

- Lead-free versus SnPb soldering; note that a lead-free reflow process usually leads to higher minimum peak temperatures (see [Figure 35](#)) than a SnPb process, thus reducing the process window
- Solder paste printing issues including smearing, release, and adjusting the process window for a mix of large and small components on one board
- Reflow temperature profile; this profile includes preheat, reflow (in which the board is heated to the peak temperature) and cooling down. It is imperative that the peak temperature is high enough for the solder to make reliable solder joints (a solder paste characteristic). In addition, the peak temperature must be low enough that the packages and/or boards are not damaged. The peak temperature of the package depends on package thickness and volume and is classified in accordance with [Table 23](#) and [24](#)

Table 23. SnPb eutectic process (from J-STD-020C)

Package thickness (mm)	Package reflow temperature (°C)	
	Volume (mm ³)	
	< 350	≥ 350
< 2.5	235	220
≥ 2.5	220	220

Table 24. Lead-free process (from J-STD-020C)

Package thickness (mm)	Package reflow temperature (°C)		
	Volume (mm ³)		
	< 350	350 to 2000	> 2000
< 1.6	260	260	260
1.6 to 2.5	260	250	245
> 2.5	250	245	245

Moisture sensitivity precautions, as indicated on the packing, must be respected at all times.

Studies have shown that small packages reach higher temperatures during reflow soldering, see [Figure 35](#).

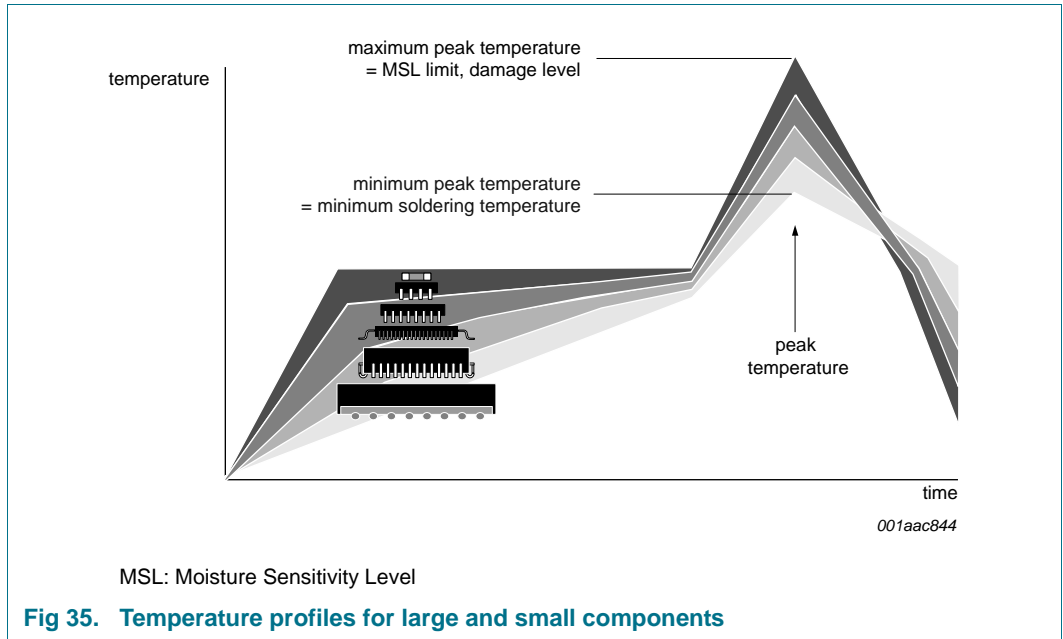

For further information on temperature profiles, refer to Application Note AN10365 “Surface mount reflow soldering description”.

18. Soldering: PCB footprints

Footprint information for reflow soldering of TSSOP24 package

SOT355-1

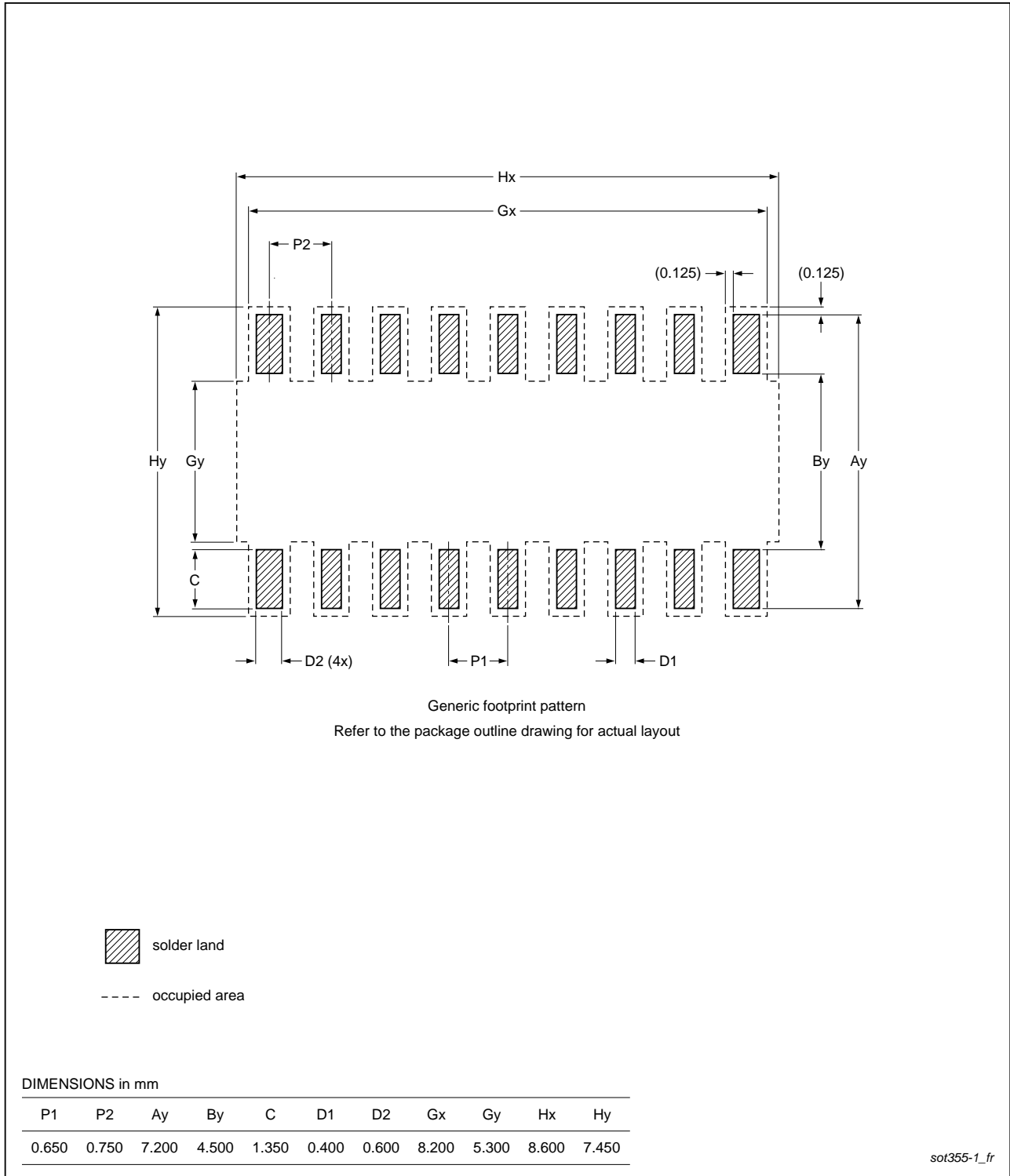

Fig 36. PCB footprint for SOT355-1 (TSSOP24); reflow soldering

Footprint information for reflow soldering of HVQFN24 package

SOT994-1

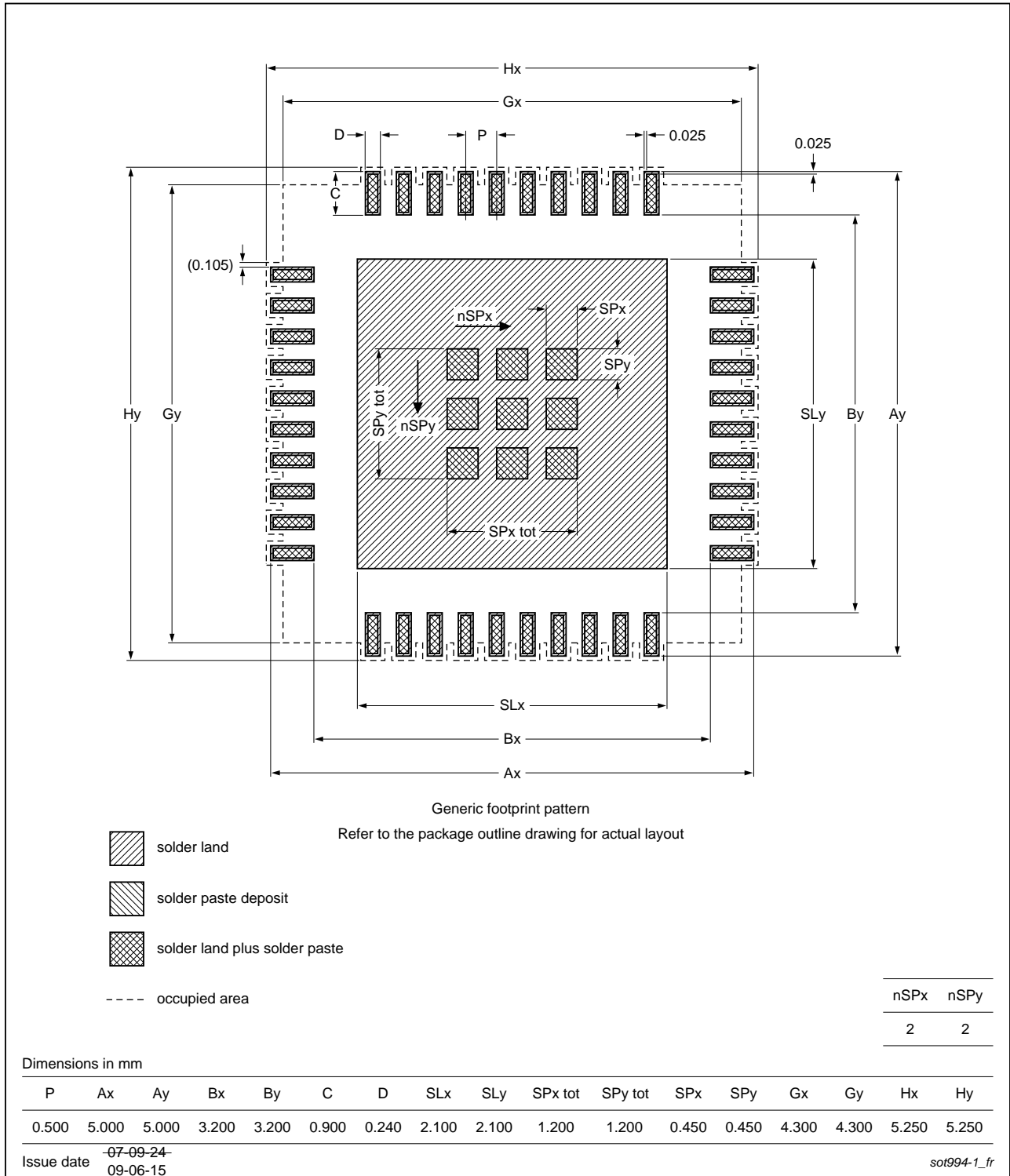

Fig 37. PCB footprint for SOT994-1 (HVQFN24); reflow soldering

19. Abbreviations

Table 25. Abbreviations

Acronym	Description
ESD	ElectroStatic Discharge
FET	Field-Effect Transistor
GPIO	General Purpose Input/Output
I ² C-bus	Inter-Integrated Circuit bus
I/O	Input/Output
LED	Light-Emitting Diode
LSB	Least Significant Bit
MSB	Most Significant Bit
NACK	Not ACKnowledge
PCB	Printed-Circuit Board
POR	Power-On Reset
PRR	Pulse Repetition Rate
SMBus	System Management Bus

20. Revision history

Table 26. Revision history

Document ID	Release date	Data sheet status	Change notice	Supersedes
PCA6416A v.2	20130110	Product data sheet	-	PCA6416A v.1
Modifications:	<ul style="list-style-type: none"> Updated Table 1 “Ordering information”: added “Topside marking” column Updated Table 2 “Ordering options”: added columns “Orderable part number”, “Packing method” and “Minimum order quantity”; topside marking column is moved to Table 1 Figure 3 “Pin configuration for HWQFN24”: corrected type number from “PCA9416AHF” to “PCA6416AHF” 			
PCA6416A v.1	20120911	Product data sheet	-	-

21. Legal information

21.1 Data sheet status

Document status ^{[1][2]}	Product status ^[3]	Definition
Objective [short] data sheet	Development	This document contains data from the objective specification for product development.
Preliminary [short] data sheet	Qualification	This document contains data from the preliminary specification.
Product [short] data sheet	Production	This document contains the product specification.

[1] Please consult the most recently issued document before initiating or completing a design.

[2] The term 'short data sheet' is explained in section "Definitions".

[3] The product status of device(s) described in this document may have changed since this document was published and may differ in case of multiple devices. The latest product status information is available on the Internet at URL <http://www.nxp.com>.

21.2 Definitions

Draft — The document is a draft version only. The content is still under internal review and subject to formal approval, which may result in modifications or additions. NXP Semiconductors does not give any representations or warranties as to the accuracy or completeness of information included herein and shall have no liability for the consequences of use of such information.

Short data sheet — A short data sheet is an extract from a full data sheet with the same product type number(s) and title. A short data sheet is intended for quick reference only and should not be relied upon to contain detailed and full information. For detailed and full information see the relevant full data sheet, which is available on request via the local NXP Semiconductors sales office. In case of any inconsistency or conflict with the short data sheet, the full data sheet shall prevail.

Product specification — The information and data provided in a Product data sheet shall define the specification of the product as agreed between NXP Semiconductors and its customer, unless NXP Semiconductors and customer have explicitly agreed otherwise in writing. In no event however, shall an agreement be valid in which the NXP Semiconductors product is deemed to offer functions and qualities beyond those described in the Product data sheet.

21.3 Disclaimers

Limited warranty and liability — Information in this document is believed to be accurate and reliable. However, NXP Semiconductors does not give any representations or warranties, expressed or implied, as to the accuracy or completeness of such information and shall have no liability for the consequences of use of such information. NXP Semiconductors takes no responsibility for the content in this document if provided by an information source outside of NXP Semiconductors.

In no event shall NXP Semiconductors be liable for any indirect, incidental, punitive, special or consequential damages (including - without limitation - lost profits, lost savings, business interruption, costs related to the removal or replacement of any products or rework charges) whether or not such damages are based on tort (including negligence), warranty, breach of contract or any other legal theory.

Notwithstanding any damages that customer might incur for any reason whatsoever, NXP Semiconductors' aggregate and cumulative liability towards customer for the products described herein shall be limited in accordance with the *Terms and conditions of commercial sale* of NXP Semiconductors.

Right to make changes — NXP Semiconductors reserves the right to make changes to information published in this document, including without limitation specifications and product descriptions, at any time and without notice. This document supersedes and replaces all information supplied prior to the publication hereof.

Suitability for use — NXP Semiconductors products are not designed, authorized or warranted to be suitable for use in life support, life-critical or safety-critical systems or equipment, nor in applications where failure or malfunction of an NXP Semiconductors product can reasonably be expected to result in personal injury, death or severe property or environmental damage. NXP Semiconductors and its suppliers accept no liability for inclusion and/or use of NXP Semiconductors products in such equipment or applications and therefore such inclusion and/or use is at the customer's own risk.

Applications — Applications that are described herein for any of these products are for illustrative purposes only. NXP Semiconductors makes no representation or warranty that such applications will be suitable for the specified use without further testing or modification.

Customers are responsible for the design and operation of their applications and products using NXP Semiconductors products, and NXP Semiconductors accepts no liability for any assistance with applications or customer product design. It is customer's sole responsibility to determine whether the NXP Semiconductors product is suitable and fit for the customer's applications and products planned, as well as for the planned application and use of customer's third party customer(s). Customers should provide appropriate design and operating safeguards to minimize the risks associated with their applications and products.

NXP Semiconductors does not accept any liability related to any default, damage, costs or problem which is based on any weakness or default in the customer's applications or products, or the application or use by customer's third party customer(s). Customer is responsible for doing all necessary testing for the customer's applications and products using NXP Semiconductors products in order to avoid a default of the applications and the products or of the application or use by customer's third party customer(s). NXP does not accept any liability in this respect.

Limiting values — Stress above one or more limiting values (as defined in the Absolute Maximum Ratings System of IEC 60134) will cause permanent damage to the device. Limiting values are stress ratings only and (proper) operation of the device at these or any other conditions above those given in the Recommended operating conditions section (if present) or the Characteristics sections of this document is not warranted. Constant or repeated exposure to limiting values will permanently and irreversibly affect the quality and reliability of the device.

Terms and conditions of commercial sale — NXP Semiconductors products are sold subject to the general terms and conditions of commercial sale, as published at <http://www.nxp.com/profile/terms>, unless otherwise agreed in a valid written individual agreement. In case an individual agreement is concluded only the terms and conditions of the respective agreement shall apply. NXP Semiconductors hereby expressly objects to applying the customer's general terms and conditions with regard to the purchase of NXP Semiconductors products by customer.

No offer to sell or license — Nothing in this document may be interpreted or construed as an offer to sell products that is open for acceptance or the grant, conveyance or implication of any license under any copyrights, patents or other industrial or intellectual property rights.

Export control — This document as well as the item(s) described herein may be subject to export control regulations. Export might require a prior authorization from competent authorities.

Non-automotive qualified products — Unless this data sheet expressly states that this specific NXP Semiconductors product is automotive qualified, the product is not suitable for automotive use. It is neither qualified nor tested in accordance with automotive testing or application requirements. NXP Semiconductors accepts no liability for inclusion and/or use of non-automotive qualified products in automotive equipment or applications.

In the event that customer uses the product for design-in and use in automotive applications to automotive specifications and standards, customer (a) shall use the product without NXP Semiconductors' warranty of the product for such automotive applications, use and specifications, and (b) whenever customer uses the product for automotive applications beyond NXP Semiconductors' specifications such use shall be solely at customer's

own risk, and (c) customer fully indemnifies NXP Semiconductors for any liability, damages or failed product claims resulting from customer design and use of the product for automotive applications beyond NXP Semiconductors' standard warranty and NXP Semiconductors' product specifications.

Translations — A non-English (translated) version of a document is for reference only. The English version shall prevail in case of any discrepancy between the translated and English versions.

21.4 Trademarks

Notice: All referenced brands, product names, service names and trademarks are the property of their respective owners.

I²C-bus — logo is a trademark of NXP B.V.

22. Contact information

For more information, please visit: <http://www.nxp.com>

For sales office addresses, please send an email to: salesaddresses@nxp.com

23. Contents

1	General description	1	20	Revision history	39
2	Features and benefits	2	21	Legal information	40
3	Ordering information	3	21.1	Data sheet status	40
3.1	Ordering options	3	21.2	Definitions	40
4	Block diagram	3	21.3	Disclaimers	40
5	Pinning information	4	21.4	Trademarks	41
5.1	Pinning	4	22	Contact information	41
5.2	Pin description	5	23	Contents	42
6	Voltage translation	6			
7	Functional description	6			
7.1	Device address	6			
7.2	Interface definition	7			
7.3	Pointer register and command byte	7			
7.4	Register descriptions	8			
7.4.1	Input port registers (00h, 01h)	8			
7.4.2	Output port registers (02h, 03h)	8			
7.4.3	Polarity inversion registers (04h, 05h)	9			
7.4.4	Configuration registers (06h, 07h)	9			
7.5	I/O port	10			
7.6	Power-on reset	10			
7.7	Reset input ($\overline{\text{RESET}}$)	11			
7.8	Interrupt output ($\overline{\text{INT}}$)	11			
8	Bus transactions	11			
8.1	Write commands	11			
8.2	Read commands	13			
9	Application design-in information	16			
9.1	Minimizing I _{DD} when the I/Os are used to control LEDs	16			
9.2	Power-on reset requirements	17			
10	Limiting values	19			
11	Recommended operating conditions	19			
12	Thermal characteristics	20			
13	Static characteristics	20			
13.1	Typical characteristics	22			
14	Dynamic characteristics	26			
15	Parameter measurement information	27			
16	Package outline	31			
17	Soldering of SMD packages	34			
17.1	Introduction to soldering	34			
17.2	Wave and reflow soldering	34			
17.3	Wave soldering	34			
17.4	Reflow soldering	35			
18	Soldering: PCB footprints	37			
19	Abbreviations	39			

Please be aware that important notices concerning this document and the product(s) described herein, have been included in section 'Legal information'.

© NXP B.V. 2013.

All rights reserved.

For more information, please visit: <http://www.nxp.com>

For sales office addresses, please send an email to: salesaddresses@nxp.com

Date of release: 10 January 2013

Document identifier: PCA6416A

Looking for pricing, stock, or lifecycle information?

Click below to explore more details on WIN SOURCE:

- ⊖ [View PCA6416APW,118 on WIN SOURCE](#)
- ⊖ [NXP / Nexperia Information](#)

Optimize Your Supply Chain with WIN SOURCE Solutions

- ✓ Global Sourcing Solution
- ✓ Obsolete Management
- ✓ Cost Control Management
- ✓ Shortage Management
- ✓ Alternative Solution
- ✓ Excess Inventory Management