



**THE DATASHEET OF
DF61-2226SCF(41)**



Board-to-Wire Swing-Lock Connector for Low-Profile Power Source

DF61 Series

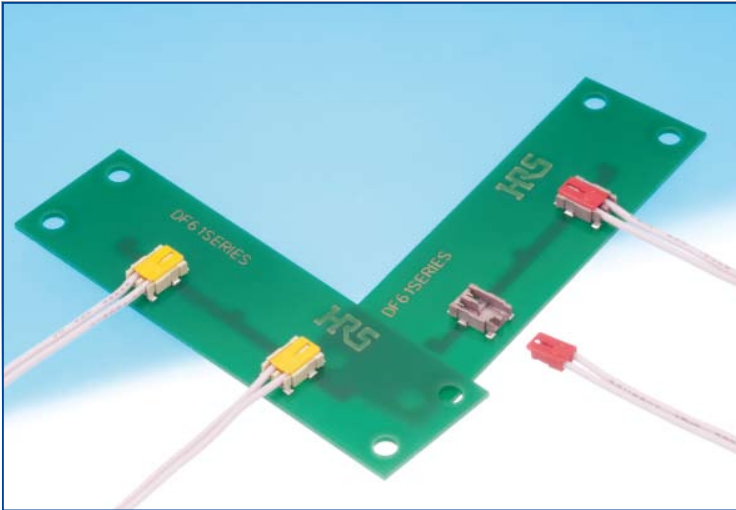

Swing-Lock Structure Illustration

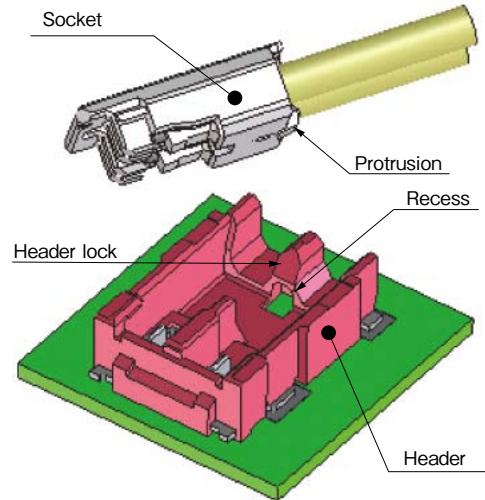

The protrusion on the bottom side of the socket fits into a corresponding recess on the header. This aligns the socket into the correct mating position.

Before Mating

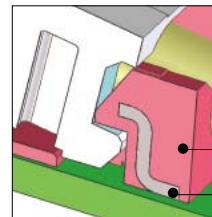

Reinforced with Metal

After Mating

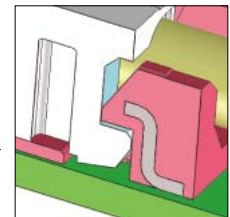

The Header pushes down the protrusion of the socket and locks it in place.

The metal fitting is partly molded in the header's housing lock.

Tensile strength of the cable: 10N or greater

■ Features

1.Reinforced Swing Lock Structure

Our unique swing-lock structure cradles the wire side plug and resists the plug from becoming disengaged due to handling strain or loads.

2.Header Lock Improves Plug Retention

During mating, the header lock engages with the plug assembly. The lock is reinforced with metal which adds strength to the lock and increases the retention between the header and the plug.

3.Compact Size- High Voltage

The compact 2.2 mm pitch connector has a voltage rating of 350V due to the long creep distance.

4.Solder Wicking Prevention

Header is molded in one piece. This ensures a tight fit between the contact and the header and prevents solder wicking.

5.High Current of MAX 5 Amps (AWG22)

A highly conductive material is used for the contacts. The material provides for a high current flow by reducing the contact resistance.

■ Applications

Digital cameras, digital video cameras, LED lights, laptop computers, tablet computers, portable devices, power supply equipment, etc.

Maximum Creep Distance

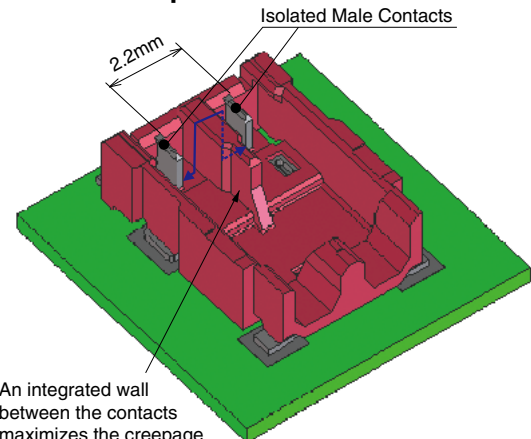

Product Specifications

Ratings	Current rating	3.2A (with AWG26) 4A (with AWG24) 5A (with AWG22)	Operating Temperature Range Operating Humidity Range	-35~85°C 20~80%	(Note 1)
	Voltage rating	AC/DC 350V	Storage Temperature Range Storage Humidity Range	-10~60°C 40~70%	(Note 2) (Note 2)

Items	Specifications	Conditions
1. Insulation resistance	1000MΩ or greater	Measured at DC 500V
2. Withstanding voltage	No flashover or breakdown	AC1700V applied for one minute
3. Contact resistance	10mΩ or less	Measured at 20mV or less, 1mA
4. Vibration resistance	No electric outage of 1μs or more	Frequency 10-55Hz, half amplitude 0.75 mm, 10 cycles for each of 3 directions
5. Shock resistance	No electric outage of 1μs or more	Acceleration 490 m/s ² , 11ms; half sin wave: 3 each for 3 directions
6. Humidity resistance	Contact resistance 20mΩ or less, insulation resistance 500MΩ or greater	Temperature 40 ± 2°C, humidity 90-95%, left for 96 hours
7. Temperature cycle	Contact resistance 20mΩ or less insulation resistance 500MΩ or greater	5 cycles (-55°C: 30 minutes → 5-35°C: 2-3 minutes → 85°C: 30 minutes → 5-35°C: 2-3 minutes)
8. Insertion/extraction life	Contact resistance 20mΩ or less	Insertion/extraction: 30 times
9. Solder heat resistance	No melting of resin part affecting performance	Reflow: Per recommended temperature profile Hand solder: Manual soldering iron 350±10°C for 3 seconds

(Note 1) Includes temperature elevation by conduction.

(Note 2) The term "storage" refers to the long-term storage conditions of unused connectors before PCB mounting. The operating temperature range applies to connectors in non-conduction state after PCB mounting or those in temporary storage during transportation, etc.

(Note 3) The above specifications are representative for this series. Please refer to "delivery specifications" for official individual agreement.

Materials

Product	Part	Material	Treatment	Specification
Header	Insulator	LCP resin	Red	UL94V-0
	Contact	Brass	Tin plated	—
Crimp Socket	Insulator	PBT	Red	UL94V-0
Crimp contact	Contact	Copper Alloy	Tin plated	—

Product Number Structure

See Pages 4-6 of this catalog to select and order specific items.

Header

DF **61** - ***** **P** - **2.2** **V**

① ② ③ ④ ⑤ ⑥

① Series Name: DF	⑤ Pitch: 2.2mm
② Series No.: 61	⑥ Termination form V: SMT straight type
③ Number of contacts: 2	
④ Type of connector P: Header	

Crimp Housing

DF **61** - ***** **S** - **2.2** **C**

① ② ③ ④ ⑤ ⑥

① Series Name: DF	⑤ Pitch: 2.2mm
② Series No.: 61	⑥ Termination form C: Crimp case
③ Number of contacts: 2	
④ Type of connector S: Socket	

Contact

DF **61** - **2628** **SCF**

① ②

① Applicable Wire Size 2628:AWG# 26-28 2226:AWG# 22-26	② Form Type/Package Type SCF: Socket crimp contact/reel
--	--

■Straight Header (SMT)

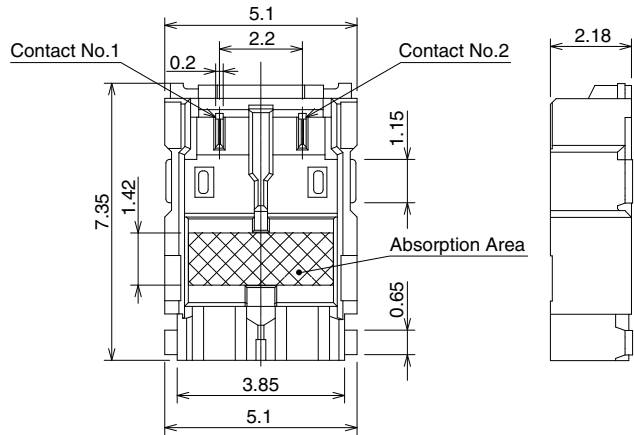
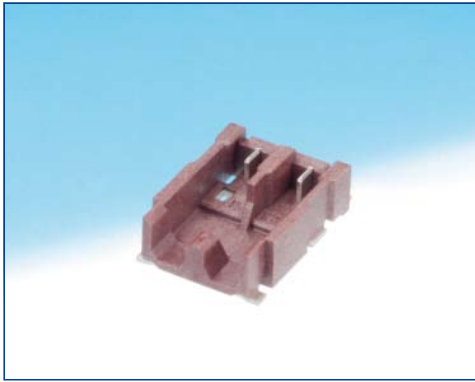

■Recommended PCB Dimensions(t=1mm)

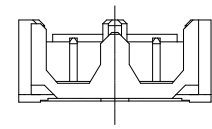
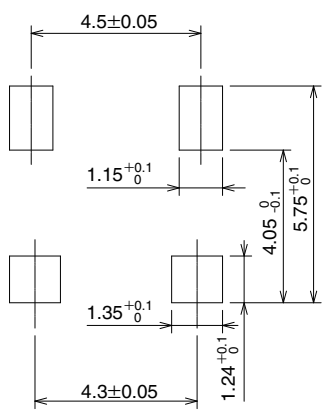

[Specification No.]
 (21): Tin plated, emboss package, mold color: red
 (22): Tin plated, emboss package, mold color: yellow
 (23): Tin plated, emboss package, mold color: beige

Unit : mm

Product Number	HRS No.	No. of contacts	Color
DF61-2P-2.2V(21)	CL666-5001-1-21	2	Red
DF61-2P-2.2V(22)	CL666-5001-1-22	2	Yellow
DF61-2P-2.2V(23)	CL666-5001-1-23	2	Beige

Note: For embossed package products, please order in full reel quantities. (1 reel = 3000 pcs.).

●Reel Dimensions

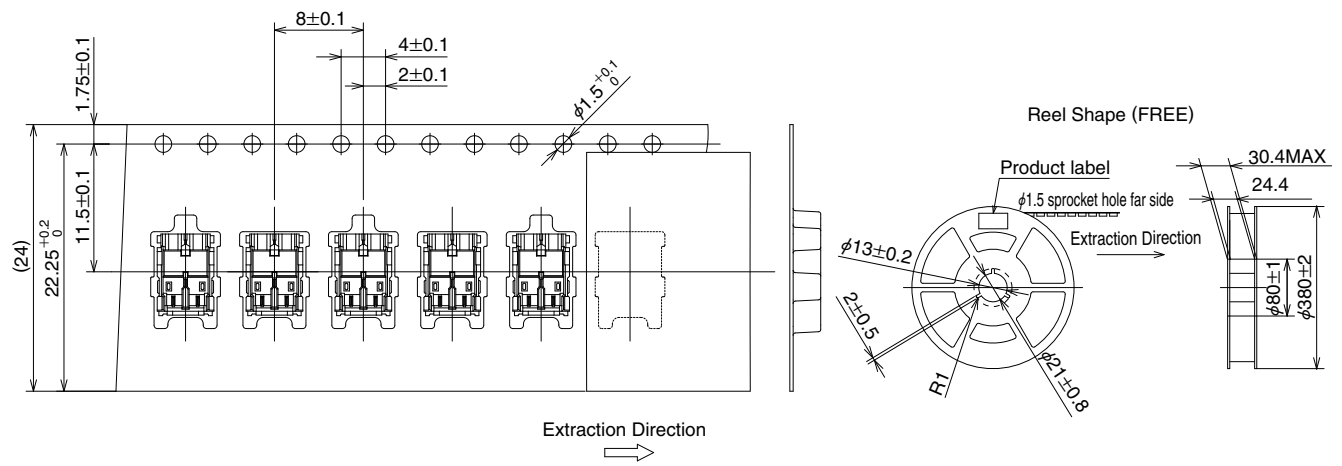

Socket

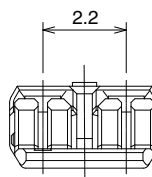
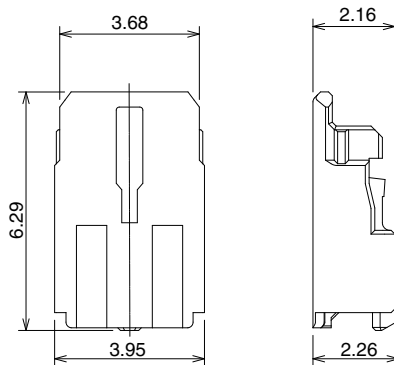
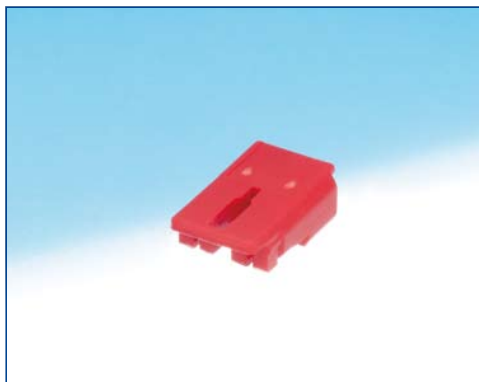

[Specification No.]

(11): 1,000 connectors per pack, mold color: red
 (12): 1,000 connectors per pack, mold color: yellow
 (13): 1,000 connectors per pack, mold color: white

Unit : mm

Product Number	HRS No.	No. of contacts	Color
DF61-2S-2.2C(11)	CL666-5002-4-11	2	Red
DF61-2S-2.2C(12)	CL666-5002-4-12	2	Yellow
DF61-2S-2.2C(13)	CL666-5002-4-13	2	White

Note: Please order by full packs (1,000 pcs./pack)

■Crimp contact

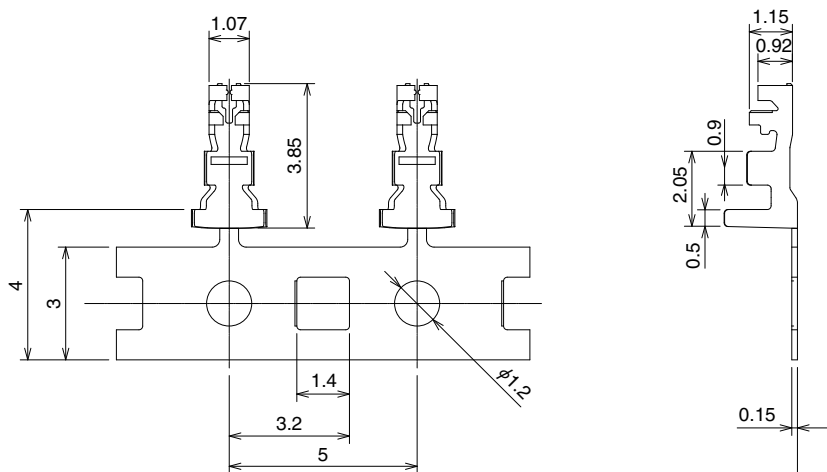

Product Number	HRS No.	Type	Quantity	Treatment
DF61-2628SCF	CL666-5005-2-00	Reel contact	18,000 contacts per reel	Tin plated
DF61-2226SCF (41)	CL666-5004-0-41	Reel contact	18,000 contacts per reel	Tin plated

(Note1) Please order in full reel quantities. (1 reel = 18,000 pcs.)

●Applicable Wire (Tin plated soft copper wire)

Conductor Size	Coating Diameter
AWG# 26-28	φ 0.7mm - 1.1mm
AWG# 22-26	φ 1.0mm - 1.3mm

Note: Please consult with our a Hirose sales representative when using wires other than those recommended below.

●Applicable wires: UL10368 AWG#22, AWG#24, AWG#26, AWG#28

●Strip Length 1.3 - 1.7mm

■Applicable Crimping Tools

Types	Product Number	HRS No.	Applicable Contact
Applicator	AP105-DF61-2628S	CL901-4632-6-00	DF61-2628SCF
	AP105-DF61-2226S	CL901-4621-0-00	DF61-2226SCF
Press Unit	CM-105	CL901-0005-4-00	—————
Hand Tool	HT305/DF61-2628S	CL550-0305-5-00	DF61-2628SCF
	HT305/DF61-2226S	CL550-0304-2-00	DF61-2226SCF
Extraction Tool	DF-C-PO(B)	CL550-0179-2-00	DF61-2628SCF, DF61-2226SCF

Note: Problems resulting from the use of non-authorized tools will not be warranted.

Operating Precautions

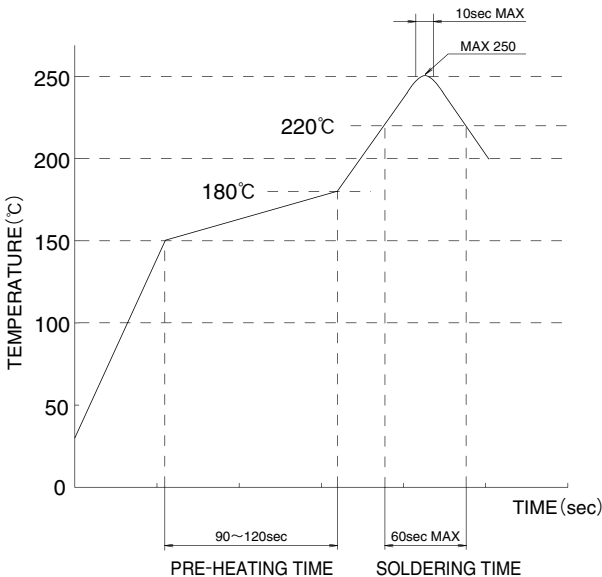
<p>1. Recommended Temperature Profile (Lead-free soldering possible)</p>	 <p>[Applicable Conditions]</p> <ol style="list-style-type: none"> 1. Peak Temperature: MAX 250°C 2. Heated Area: 220°C or above, within 60 sec. 3. Pre-heating Area: 150-180°C, 90-120 sec. 4. Number of Operation: Twice or less <p>* The contact lead area was measured. The conditions may change depending on the types and manufacturers of cream solder, PCB size, and conditions of other materials used for soldering. Please fully check the soldering condition before use. [Remarks 1] This temperature profile is our recommended value.</p>
<p>2. Recommended Hand Solder Conditions</p>	<p>Soldering iron temperature: 350 ± 10°C, soldering time: within 3 seconds</p>
<p>3. Recommended Screen Thickness, Aperture Opening Rate (Pattern Area Ratio)</p>	<p>Thickness 0.1 mm, aperture opening rate: 100%</p>
<p>4. PCB Warpage</p>	<p>Max 0.02 mm at the center of connector with the both edges of the connector as the baseline</p>
<p>5. Cleaning Condition</p>	<p>Cleaning with IPA is possible. (Cleaning is not recommended as it may change the feel of insertion/extraction, etc. Please consult with us when using other types of cleaning agents.)</p>
<p>6. Precautions</p>	<ul style="list-style-type: none"> ■ In order to maintain the performance reliability, do not insert the crimp contact into the crimp socket at a slant angle. ■ Insertion/extraction of the connector while not mounted to the PCB may cause breakage or deformation to the contact. ■ Extracting the connector by holding the cable could result in a breakage. ■ Do not apply flux at the time of hand soldering, as it may result in flux rise. ■ This product may have slightly different hue on molded items, however, they do not affect the product performance. ■ See the separate "DF59 Insertion/Extraction Procedure Manual" for handling precautions at the time of insertion and extraction.

7. Mating/Un-mating
Mating Operation

(1) Start by placing the connector against the header lock at an angle. If the plug is not started at an angle, it will cause damage to the connector.

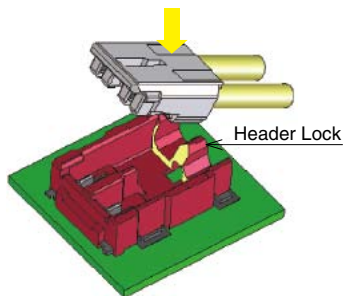

(2) Then, in a slight, rotating movement, push the front section of the plug down.

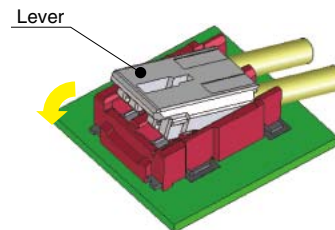

(3) Keep pressing down until a "click" feeling is sensed. The connector is now fully and properly mated.

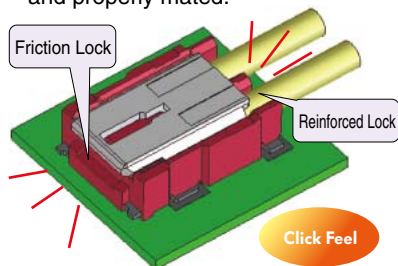

Un-mating Operation

(1) Begin by lifting up on the front section of the plug.

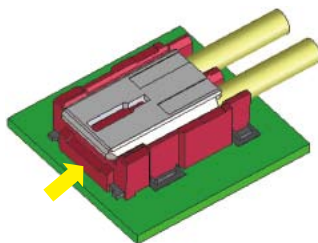

(2) Continue to rotate it upwards and release the friction lock portion.

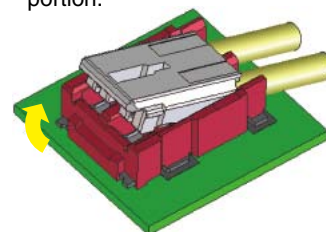

(3) Once the rear, or reinforced lock, is released the plug will come free from the header and complete the un-mating sequence.

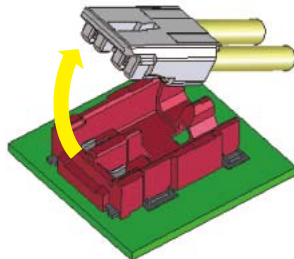

HIROSE ELECTRIC CO.,LTD.







6-3,Nakagawa Chuoh-2-Chome,Tsuzuki-Ku,Yokohama-Shi 224-8540,JAPAN
 TEL: +81-45-620-3526 Fax: +81-45-591-3726
<http://www.hirose.com>
<http://www.hirose-connectors.com>

Looking for pricing, stock, or lifecycle information?

Click below to explore more details on WIN SOURCE:

-  [View DF61-2226SCF\(41\) on WIN SOURCE](#)
-  [Hirose Electric Co Ltd Information](#)

Optimize Your Supply Chain with WIN SOURCE Solutions

-  Global Sourcing Solution
-  Obsolete Management
-  Cost Control Management
-  Shortage Management
-  Alternative Solution
-  Excess Inventory Management