



**THE DATASHEET OF
HX5062NL**



NOTES:

1. ROHS COMPLIANT
2. HEADER: THERMOSET PLASTIC MATERIAL WITH FLAMMABILITY RATING UL 94V-0 OR BETTER.
3. STORAGE TEMPERATURE: -50°C TO +125°C
4. COMPLIANCE TO J-STD:
 - A. J-STD-002: SOLDERABILITY AT 245°C REFLOW PROFILE
 - B. J-STD-020: LEVEL 1, NO MOISTURE SENSITIVE
 - C. J-STD-075: R7, 245°C MAXIMUM THROUGH REFLOW SOLDER
5. TO ORDER TAPE & REEL PACKAGING ADD A "T" SUFFIX TO THE PART NUMBER(i.e HX5062NL BECOMES HX5062NLT).

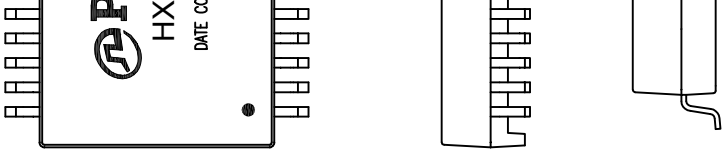

FINA

© Copyright, 2015. Pulse Electronics Corp. All rights reserved. Pulse confidential & proprietary. (07/30/15)

PRODUCT DESCRIPTION	TLA DRAWING	PS DRAWING	SHEET
MDL,SIN,1GD,1:1,SM,OH	HX5062NL-12	PS-2228.001-B	1 OF 3

E-MAIL: PRODINFONETWORK@PULSEELECTRONICS.COM(US). ASIA@PULSEELECTRONICS.COM(Asia)

PHONE: USA:858 674 8100, GERMANY:49 7032 78060. SINGAPORE:65

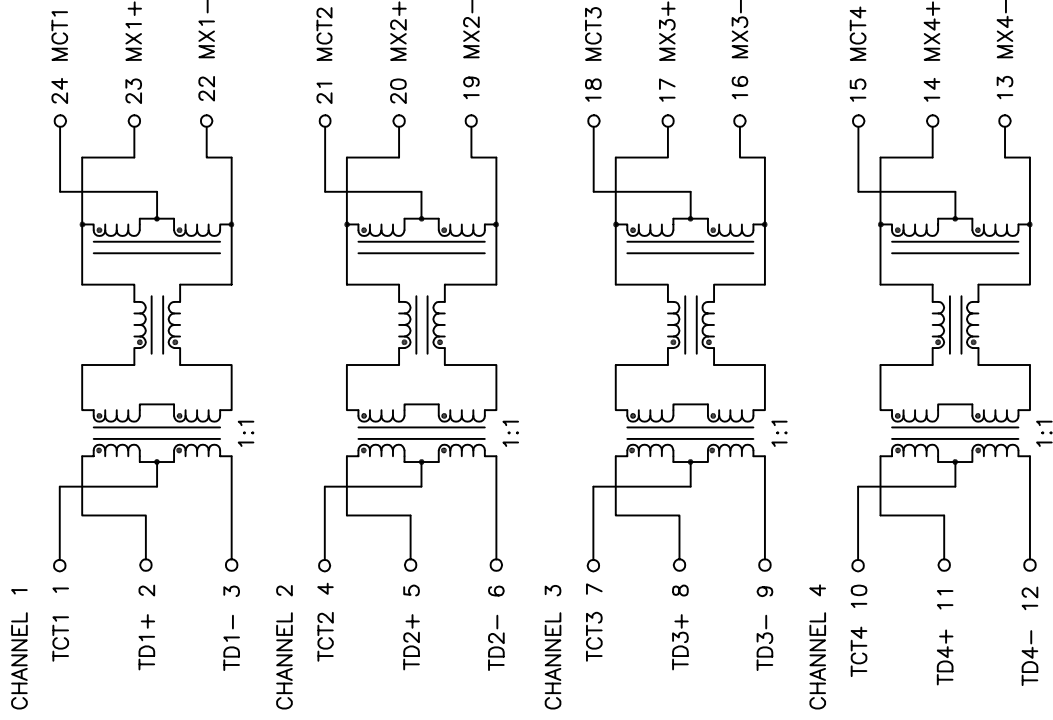

SCHEMATIC

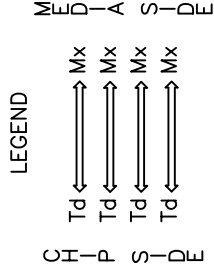

ALL CHANNELS ARE IN PHASE BETWEEN INPUT AND OUTPUT

ELECTRICAL CHARACTERISTICS MEETS IE

PARAMETER	
OPERATING TEMP	
TURNS RATIO	1
POLARITY	-1.
INSERTION LOSS	-1.
RETURN LOSS (Z OUT = 100 OHM ±15%)	-1
INDUCTANCE (OCL) (MEDIA SIDE, -40°C~85°C)	35
CROSSTALK, ADJACENT CHANNELS	-5
COMMON MODE REJECTION RATIO	-5
DC RESISTANCE, 1/2 WINDING	
DC RESISTANCE IMBALANCE	±
INPUT - OUTPUT ISOLATION	

NOTE: f IS FREQUENCY IN MHz

© Copyright, 2015. Pulse Electronics Corp. All rights reserved. Pulse confidential & proprietary. (07/30/15)

PRODUCT DESCRIPTION	TLA DRAWING	PS DRAWING	SHEET
MDL,SIN,1GD,1:1,SM,OH	HX5062NL-12	PS-2228.001-B	2 OF 3

E-MAIL: PRODINFONETWORK@PULSEELECTRONICS.COM(US). ASIA@PULSEELECTRONICS.COM(Asia)

PHONE: USA:858 674 8100, GERMANY:49 7032 78060, SINGAPORE:65

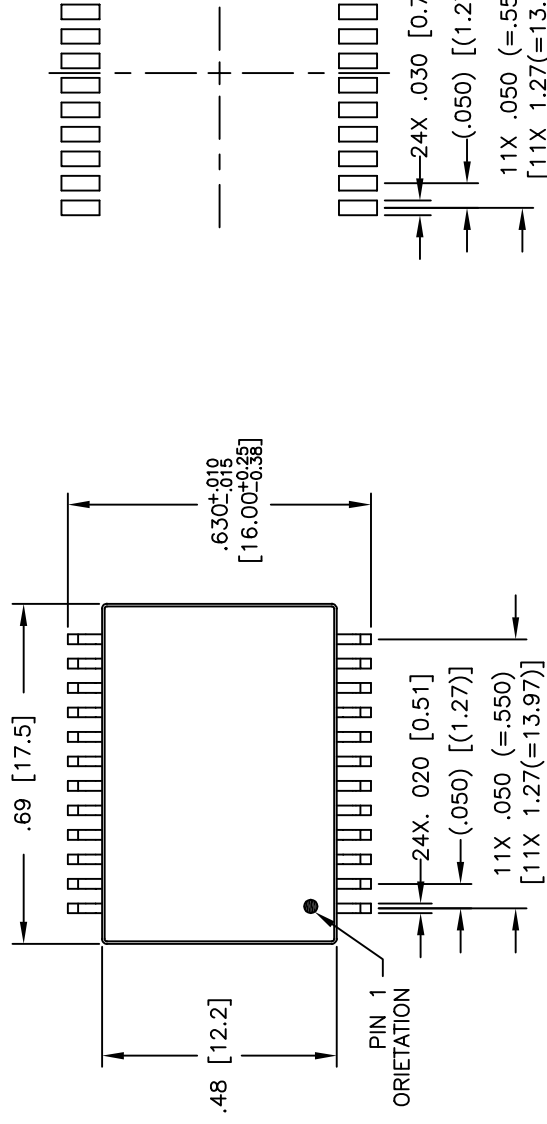

SUGGESTED LAND P

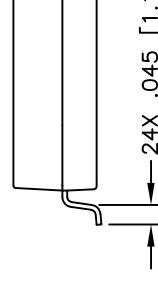
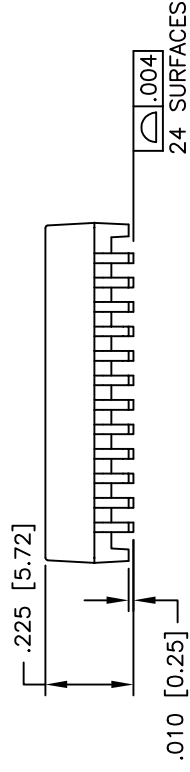

DIMENSIONS ARE IN INCHES [MILLIMETERS] WITH THE FOLLOWING TOLERANCES: [MILLIMETERS] ARE FOR REFERENCE ONLY.
 .XX = ±0.02 [±0.5]
 .XXX = ±0.010 [±0.25]

© Copyright, 2015. Pulse Electronics Corp. All rights reserved. Pulse confidential & proprietary. (07/30/15)



PRODUCT DESCRIPTION	TLA DRAWING	PS DRAWING	SHEET
MDL,SIN,1GD,1:1,SM,OH	HX5062NL-12	PS-2228.001-B	3 OF 3

E-MAIL: PRODINFONETWORK@PULSEELECTRONICS.COM(US). ASIA@PULSEELECTRONICS.COM(Asia)

PHONE: USA:858 674 8100, GERMANY:49 7032 78060, SINGAPORE:65

Looking for pricing, stock, or lifecycle information?

Click below to explore more details on WIN SOURCE:

-  [View HX5062NL on WIN SOURCE](#)
-  [Pulse Information](#)

Optimize Your Supply Chain with WIN SOURCE Solutions

-  Global Sourcing Solution
-  Obsolete Management
-  Cost Control Management
-  Shortage Management
-  Alternative Solution
-  Excess Inventory Management