



**THE DATASHEET OF
DGD0590AFU-7**



Description

The DGD0590A is a high-frequency, high-side and low-side gate driver capable of driving N-Channel MOSFETs in a half-bridge configuration. The floating high-side driver is rated up to 40V and provides a 5V gate drive to the MOSFETs.

The DGD0590A logic inputs are compatible with standard TTL and CMOS levels (down to 3.3V) to interface easily with MCUs. A UVLO will protect ICs and MOSFETs with loss of supply.

Fast and well-matched propagation delays allow for a higher switching frequency, enabling a smaller, more compact power-switching design using smaller associated components.

The DGD0590A is offered in the V-QFN3030-8 package and operates over an extended -40°C to +125°C temperature range.

Features

- 40V Floating High-Side Driver
- Low V_{CC} Operating Voltage: 4.5V to 5.5V
- Drives Two N-Channel Logic Level MOSFETs in a Half-Bridge Configuration
- High-Side 1.0A Source / 1.0A Sink and Low-Side 1.0A Source / 3.0A Sink Output Current Capability
- Internal Bootstrap Diode Included
- 3.4V UVLO with 0.4V Hysteresis
- Fast Rise and Fall Times (27ns/17ns) with 3nF Load
- Propagation Delay Typical of 16ns for High-Side and 12ns for Low-Side
- Extended Temperature Range: -40°C to +125°C
- **Totally Lead-Free & Fully RoHS Compliant (Notes 1 & 2)**
- **Halogen and Antimony Free. "Green" Device (Note 3)**
- **For automotive applications requiring specific change control (i.e. parts qualified to AEC-Q100/101/200, PPAP capable, and manufactured in IATF 16949 certified facilities), please [contact us](#) or your local Diodes representative.**

<https://www.diodes.com/quality/product-definitions/>

Applications

- Wireless Power Chargers
- Motor Drives
- Logic Level MOSFET Gate Drivers

Mechanical Data

- Case: V-QFN3030-8 (Standard)
- Case Material: Molded Plastic. "Green" Molding Compound. UL Flammability Classification Rating 94V-0
- Moisture Sensitivity: Level 3 per J-STD-020
- Terminals: Finish – Matte Tin Finish. Solderable per MIL-STD-202, Method 208 @3
- Weight: 0.017 grams (Approximate)

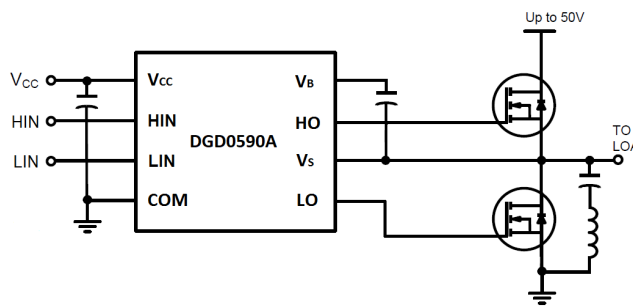

Typical Configuration

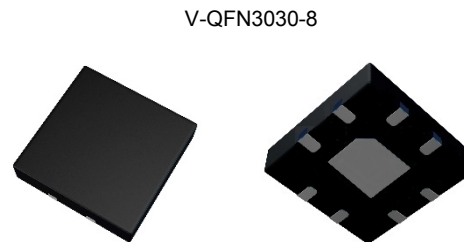

Top View

Bottom View

Ordering Information (Note 4)

| Part Number | Marking | Reel Size (inches) | Tape Width (mm) | Quantity per Reel |
|--------------|----------|--------------------|-----------------|-------------------|
| DGD0590AFU-7 | DGD0590A | 7 | 8 | 3,000 |

- Notes:
1. No purposely added lead. Fully EU Directive 2002/95/EC (RoHS), 2011/65/EU (RoHS 2) & 2015/863/EU (RoHS 3) compliant.
 2. See <https://www.diodes.com/quality/lead-free/> for more information about Diodes Incorporated's definitions of Halogen- and Antimony-free, "Green" and Lead-free.
 3. Halogen- and Antimony-free "Green" products are defined as those which contain <900ppm bromine, <900ppm chlorine (<1500ppm total Br + Cl) and <1000ppm antimony compounds.
 4. For packaging details, go to our website at <https://www.diodes.com/design/support/packaging/diodes-packaging/>.

Marking Information

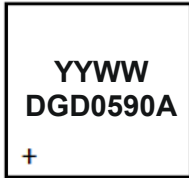

DGD0590A = Product Type Marking Code
YY = Year (ex: 21 = 2021)
WW = Week (01 to 53)

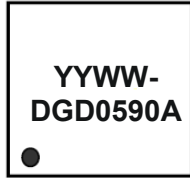

DGD0590A = Product Type Marking Code
YY = Year (ex: 21 = 2021)
WW- = Week (01 to 53)

Pin Diagrams

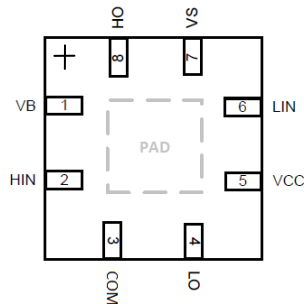

Top View: V-QFN3030-8

Pin Descriptions

| Pin Number | Pin Name | Function |
|------------|-----------|--------------------------------------------------------------------------------------|
| 1 | VB | High-Side Floating Supply |
| 2 | HIN | Logic Input for High-Side Gate Driver, in Phase with HO, Pull Down Resistor at Input |
| 3 | COM | Low-Side and Logic Return |
| 4 | LO | Low-Side Gate Driver Output |
| 5 | VCC | Low-Side and Logic Supply |
| 6 | LIN | Logic Input for Low-Side Gate Driver, in Phase with LO, Pull Down Resistor at Input |
| 7 | VS | High-Side Floating Supply Return |
| 8 | HO | High-Side Gate Driver Output |
| PAD | Substrate | Connect to COM on PCB |

Functional Block Diagram

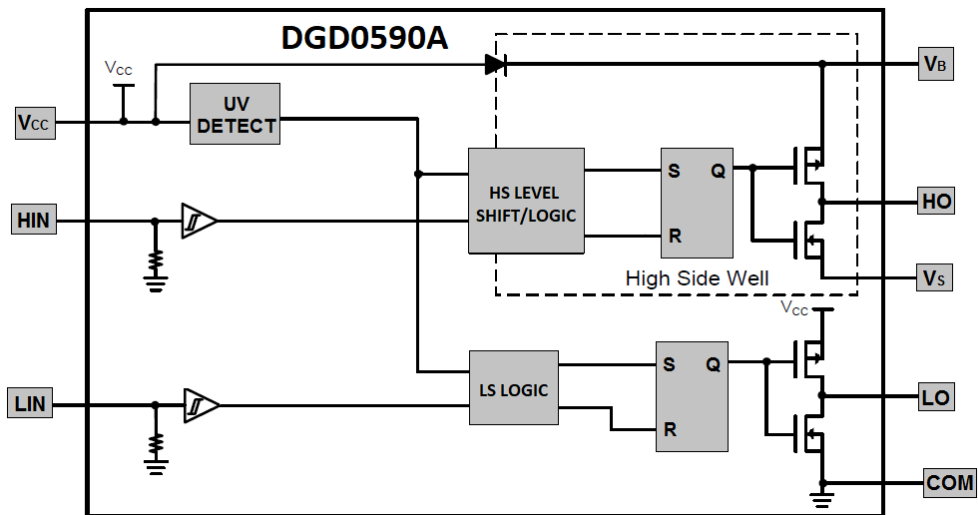

Absolute Maximum Ratings (@ $T_A = +25^\circ\text{C}$, unless otherwise specified.)

| Characteristic | Symbol | Value | Unit |
|--------------------------------------------|-------------|----------------------------|------|
| High-Side Floating Positive Supply Voltage | V_B | 0.3 to +50 | V |
| High-Side Floating Negative Supply Voltage | V_S | $V_B - 6$ to $V_B + 0.3$ | V |
| High-Side Floating Output Voltage | V_{HO} | $V_S - 0.3$ to $V_B + 0.3$ | V |
| Offset Supply Voltage Transient | dV_S / dt | 50 | V/ns |
| Logic and Low-Side Fixed Supply Voltage | V_{CC} | -0.3 to +6 | V |
| Low-Side Output Voltage | V_{LO} | -0.3 to $V_{CC} + 0.3$ | V |
| Logic Input Voltage (HIN and LIN) | V_{IN} | -0.3 to +6 | V |

Thermal Characteristics (@ $T_A = +25^\circ\text{C}$, unless otherwise specified.)

| Characteristic | Symbol | Value | Unit |
|--------------------------------------------------|-----------------|-------------|---------------------------|
| Thermal Resistance, Junction to Ambient (Note 5) | $R_{\theta JA}$ | 120 | $^\circ\text{C}/\text{W}$ |
| Thermal Resistance, Junction to Case (Note 5) | $R_{\theta JC}$ | 132 | $^\circ\text{C}/\text{W}$ |
| Operating Temperature | T_J | +150 | $^\circ\text{C}$ |
| Lead Temperature (Soldering, 10s) | T_L | +300 | |
| Storage Temperature Range | T_{STG} | -55 to +150 | |

Note: 5. When mounted on a standard JEDEC 2-layer FR-4 board.

Recommended Operating Conditions

| Parameter | Symbol | Min | Max | Unit |
|------------------------------------------|----------|-------------|-------------|------------------|
| High-Side Floating Supply | V_B | $V_S + 4.5$ | $V_S + 5.5$ | V |
| High-Side Floating Supply Offset Voltage | V_S | 0 | 40 (Note 6) | V |
| High-Side Floating Output Voltage | V_{HO} | V_S | V_B | V |
| Logic and Low Side Fixed Supply Voltage | V_{CC} | 4.5 | 5.5 | V |
| Low-Side Output Voltage | V_{LO} | 0 | V_{CC} | V |
| Logic Input Voltage (HIN and LIN) | V_{IN} | 0 | 5 | V |
| Ambient Temperature | T_A | -40 | +125 | $^\circ\text{C}$ |

Note: 6. Provided V_B doesn't exceed absolute maximum rating of 50V.

DC Electrical Characteristics ($V_{CC} = 5V$, @ $T_A = +25^\circ C$, unless otherwise specified.)

| Parameter | Symbol | Min | Typ | Max | Unit | Conditions |
|-------------------------------------------------------|-----------------|------|-----|------|----------|----------------------------------------|
| Logic "1" Input Voltage, HIN | V_{HIH} | — | 3.5 | 3.8 | V | — |
| Logic "0" Input Voltage, HIN | V_{HIL} | 1.0 | 1.3 | — | V | — |
| Logic "1" Input Voltage, LIN | V_{LIH} | — | 2.8 | 3.3 | V | — |
| Logic "0" Input Voltage, LIN | V_{LIL} | 1.0 | 1.2 | — | V | — |
| Logic Input Bias Current | I_{IN+} | — | 31 | 60 | μA | $V_{IN} = V_{CC}$ |
| V_{CC} Quiescent Supply Current | I_{CCQ} | — | 22 | 50 | μA | — |
| V_{CC} Operating Supply Current | I_{CCO} | — | 300 | — | μA | HO and LO Open, $f_s = 250kHz$ |
| High-Side Source Impedance | R_{HSO} | — | 1.8 | 2.6 | Ω | $I_{SOURCE} = 100mA$ |
| High-Side Sink Impedance | R_{HSI} | — | 1.5 | 2.1 | Ω | $I_{SINK} = 100mA$ |
| Low-Side Source Impedance | R_{LSO} | — | 1.8 | 2.6 | Ω | $I_{SOURCE} = 100mA$ |
| Low-Side Sink Impedance | R_{LSI} | — | 0.4 | 1.0 | Ω | $I_{SINK} = 100mA$ |
| V_{CC} Supply Undervoltage Positive Going Threshold | V_{CCUV+} | 2.85 | 3.4 | 3.85 | V | — |
| V_{CC} Supply Undervoltage Hysteresis | V_{CCU_HYST} | — | 0.4 | — | V | — |
| Bootstrap Diode Forward Voltage | V_{BFD} | — | 650 | 800 | mV | $I = 100\mu A$ |
| Bootstrap Diode Reverse Leakage | I_{BDL} | — | 0.1 | 0.4 | μA | $V_B = V_S = 45.5V$, $V_{CC} = 0V$ |

AC Electrical Characteristics ($V_{CC} = 5V$, $C_L = 3nF$, @ $T_A = +25^\circ C$, unless otherwise specified.)

| Parameter | Symbol | Min | Typ | Max | Unit | Conditions |
|--------------------------------------------|------------|-----|-----|-----|------|------------|
| Turn-On Rise Time | t_R | — | 27 | — | ns | — |
| Turn-Off Fall Time, High-Side | t_F | — | 29 | — | ns | — |
| Turn-Off Fall Time, Low-Side | | — | 17 | — | ns | — |
| Turn-On Propagation Delay Time, High-Side | t_{ONH} | — | 16 | — | ns | — |
| Turn-Off Propagation Delay Time, High-Side | t_{OFFH} | — | 17 | — | ns | — |
| Turn-On Propagation Delay Time, Low-Side | t_{ONL} | — | 12 | — | ns | — |
| Turn-Off Propagation Delay Time, Low-Side | t_{OFFL} | — | 17 | — | ns | — |

Timing Waveforms

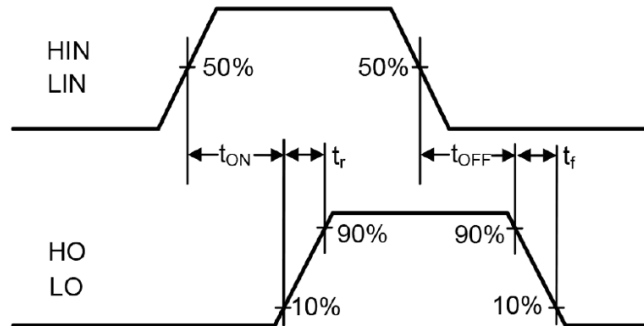

Figure 1. Switching Time Waveform Definitions

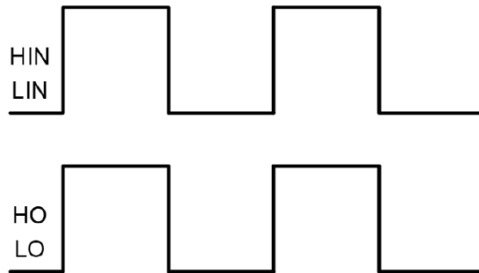

Figure 2. Input / Output Timing Diagram

Typical Performance Characteristics ($V_{CC} = 5V$, @ $T_A = +25^\circ C$, unless otherwise specified.)

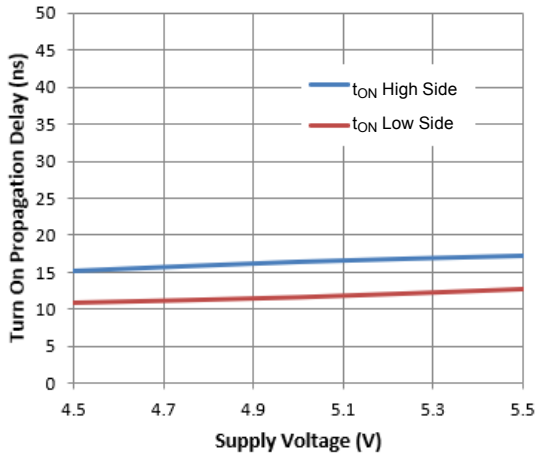

Figure 3. Turn-on Propagation Delay vs. Supply Voltage

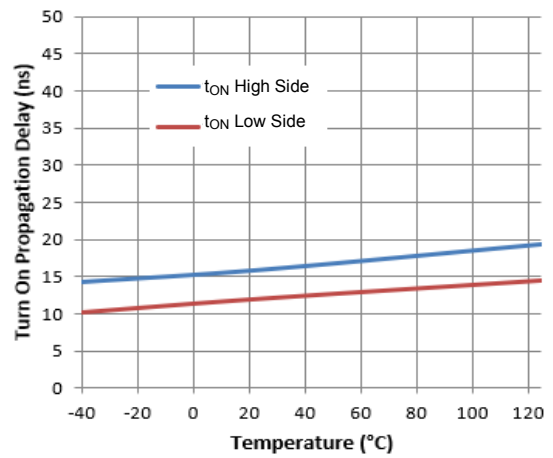

Figure 4. Turn-on Propagation Delay vs. Temperature

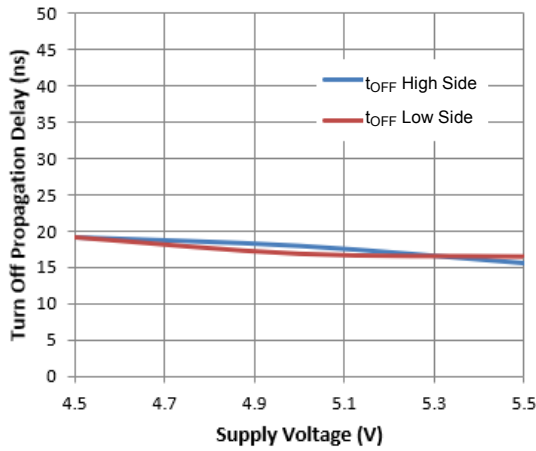

Figure 5. Turn-off Propagation Delay vs. Supply Voltage

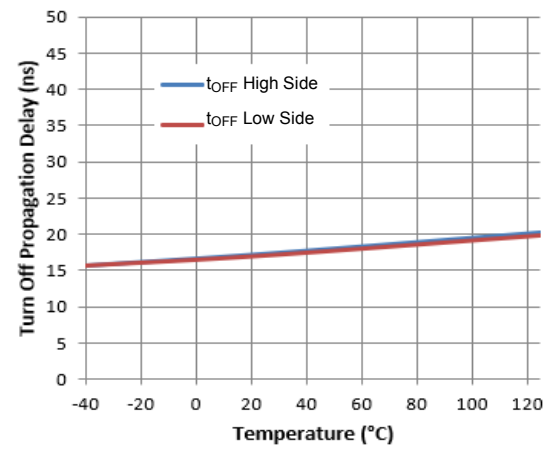

Figure 6. Turn-off Propagation Delay vs. Temperature

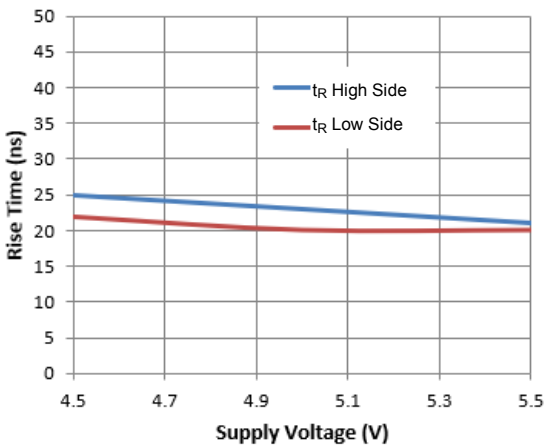

Figure 7. Rise Time vs. Supply Voltage

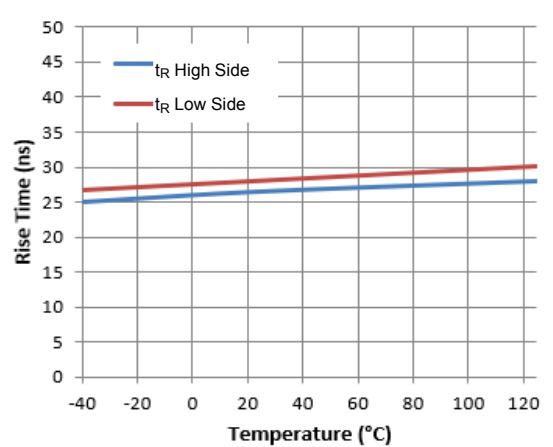

Figure 8. Rise Time vs. Temperature

Typical Performance Characteristics (continued)

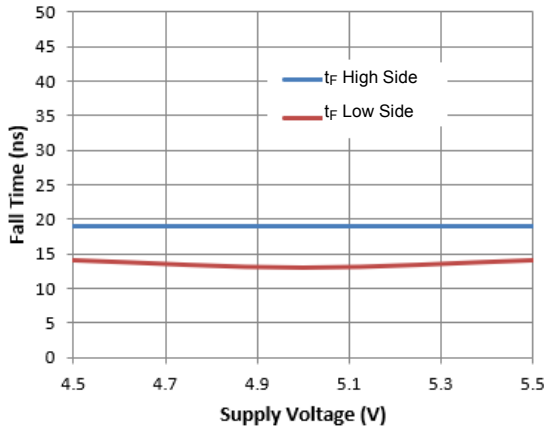

Figure 9. Fall Time vs. Supply Voltage

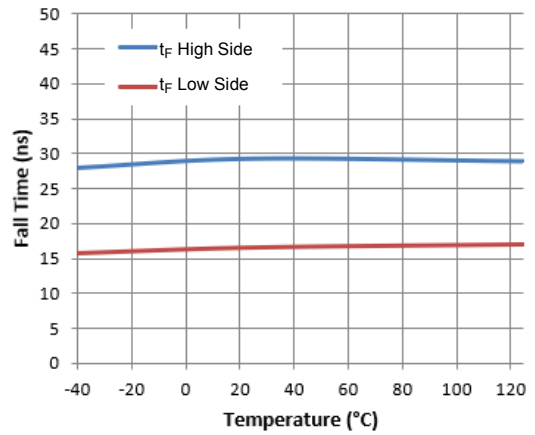

Figure 10. Fall Time vs. Temperature

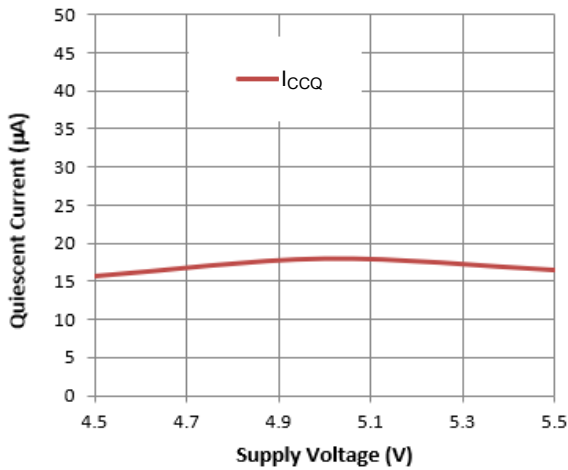

Figure 11. Quiescent Current vs. Supply Voltage

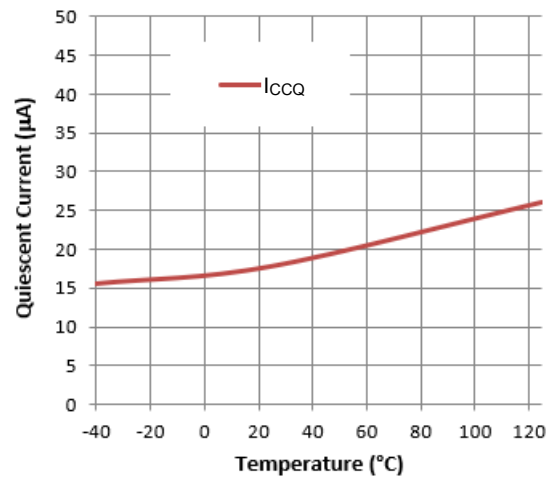

Figure 12. Quiescent Current vs. Temperature

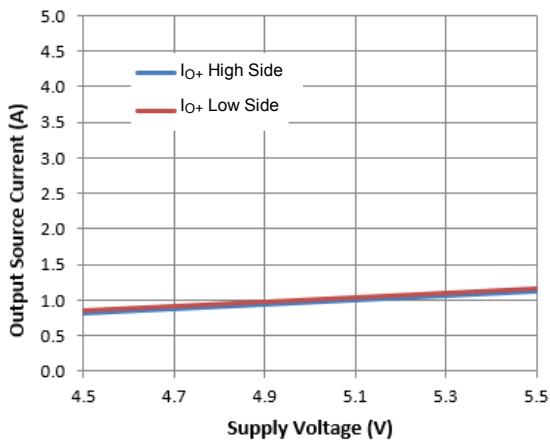

Figure 13. Output Source Current vs. Supply Voltage

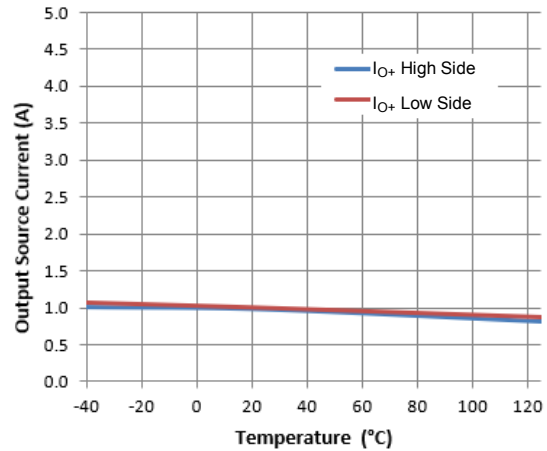

Figure 14. Output Source Current vs. Temperature

Typical Performance Characteristics (continued)

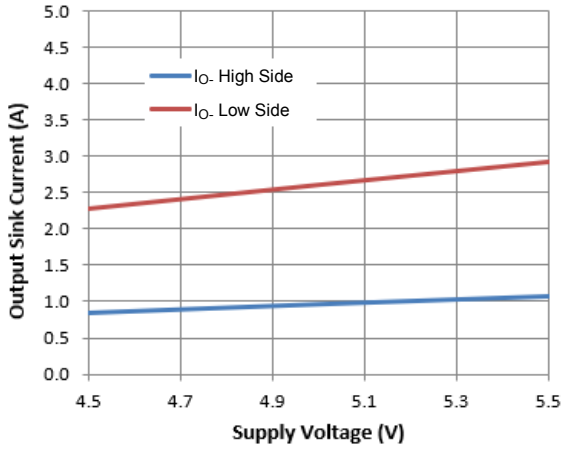

Figure 15. Output Sink Current vs. Supply Voltage

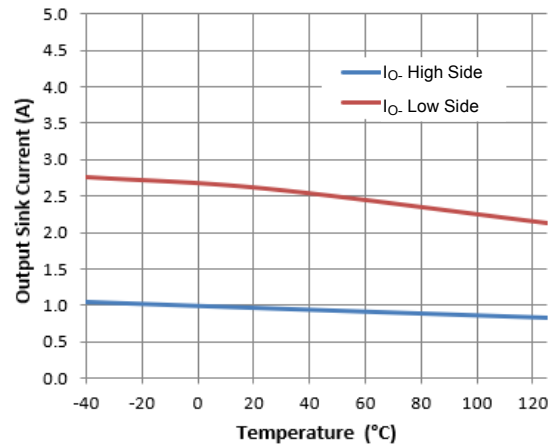

Figure 16. Output Sink Current vs. Temperature

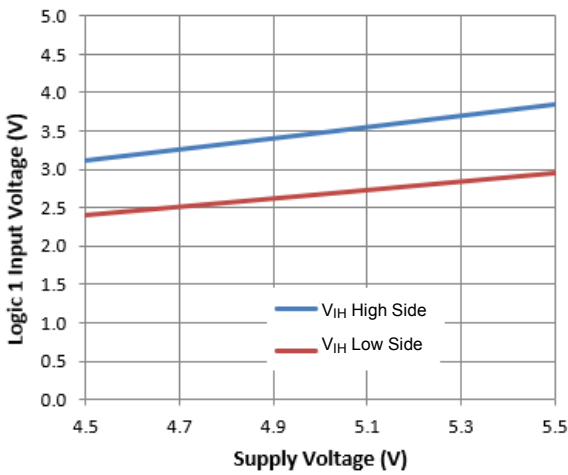

Figure 17. Logic 1 Input Voltage vs. Supply Voltage

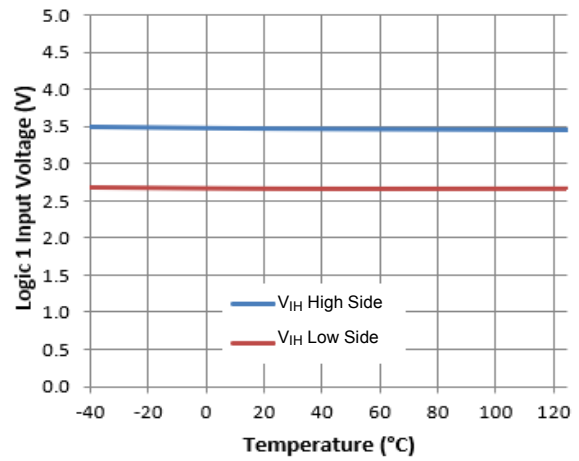

Figure 18. Logic 1 Input Voltage vs. Temperature

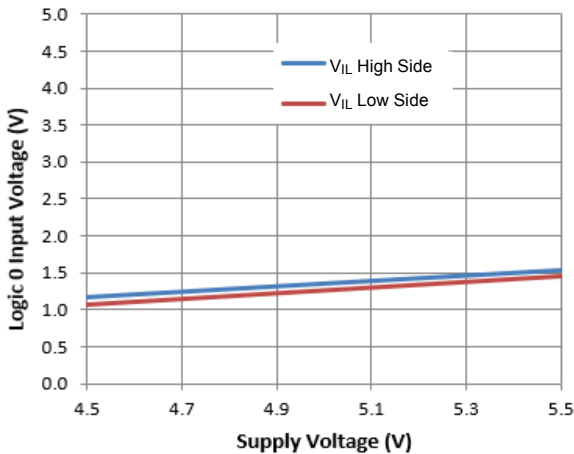

Figure 19. Logic 0 Input Voltage vs. Supply Voltage

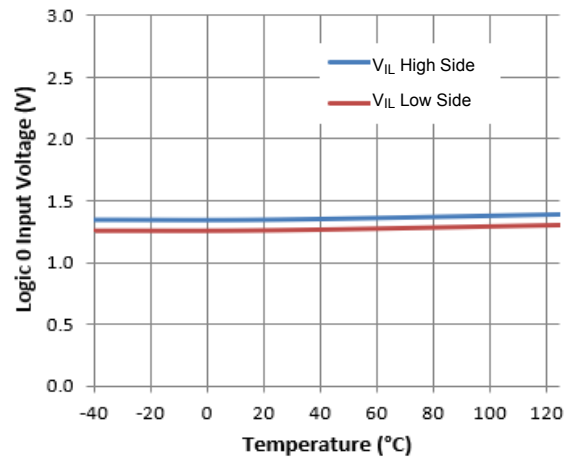

Figure 20. Logic 0 Input Voltage vs. Temperature

Typical Performance Characteristics (continued)

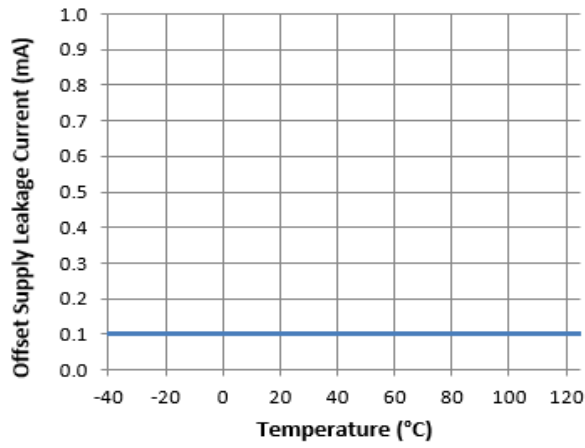
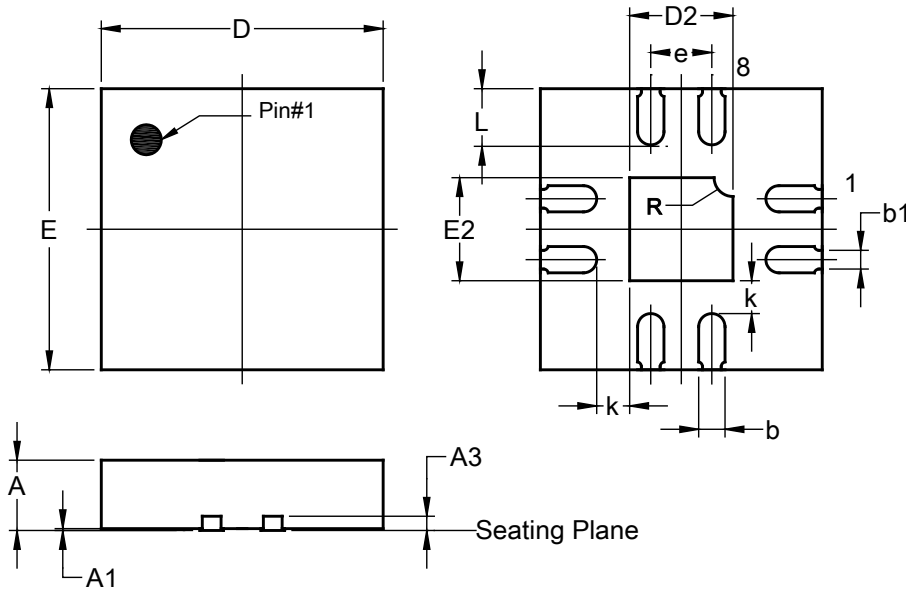

Figure 21. Offset Supply Leakage Current vs. Temperature

Package Outline Dimensions

Please see <http://www.diodes.com/package-outlines.html> for the latest version.

V-QFN3030-8 (Standard)



| V-QFN3030-8 (Standard) | | | |
|-----------------------------|----------|------|------|
| Dim | Min | Max | Typ |
| A | 0.70 | 0.85 | 0.75 |
| A1 | 0.00 | 0.05 | 0.02 |
| A3 | 0.203REF | | |
| b | 0.23 | 0.33 | 0.28 |
| b1 | 0.20REF | | |
| D | 2.90 | 3.10 | 3.00 |
| D2 | 1.00 | 1.20 | 1.10 |
| E | 2.90 | 3.10 | 3.00 |
| E2 | 1.00 | 1.20 | 1.10 |
| e | 0.65BSC | | |
| L | 0.55 | 0.65 | 0.60 |
| k | 0.30 | 0.40 | 0.35 |
| R | 0.20REF | | |
| All Dimensions in mm | | | |

Suggested Pad Layout

Please see <http://www.diodes.com/package-outlines.html> for the latest version.

V-QFN3030-8 (Standard)

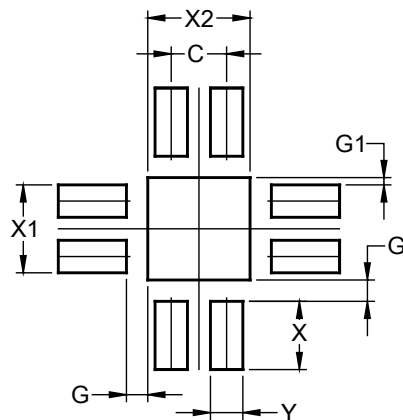

| Dimensions | Value (in mm) |
|------------|---------------|
| C | 0.650 |
| G | 0.250 |
| G1 | 0.085 |
| X | 0.800 |
| X1 | 1.030 |
| X2 | 1.200 |
| Y | 0.380 |

IMPORTANT NOTICE



1. DIODES INCORPORATED AND ITS SUBSIDIARIES (“DIODES”) MAKE NO WARRANTY OF ANY KIND, EXPRESS OR IMPLIED, WITH REGARDS TO ANY INFORMATION CONTAINED IN THIS DOCUMENT, INCLUDING, BUT NOT LIMITED TO, THE IMPLIED WARRANTIES OF MERCHANTABILITY, FITNESS FOR A PARTICULAR PURPOSE OR NON-INFRINGEMENT OF THIRD PARTY INTELLECTUAL PROPERTY RIGHTS (AND THEIR EQUIVALENTS UNDER THE LAWS OF ANY JURISDICTION).
2. The Information contained herein is for informational purpose only and is provided only to illustrate the operation of Diodes products described herein and application examples. Diodes does not assume any liability arising out of the application or use of this document or any product described herein. This document is intended for skilled and technically trained engineering customers and users who design with Diodes products. Diodes products may be used to facilitate safety-related applications; however, in all instances customers and users are responsible for (a) selecting the appropriate Diodes products for their applications, (b) evaluating the suitability of the Diodes products for their intended applications, (c) ensuring their applications, which incorporate Diodes products, comply the applicable legal and regulatory requirements as well as safety and functional-safety related standards, and (d) ensuring they design with appropriate safeguards (including testing, validation, quality control techniques, redundancy, malfunction prevention, and appropriate treatment for aging degradation) to minimize the risks associated with their applications.
3. Diodes assumes no liability for any application-related information, support, assistance or feedback that may be provided by Diodes from time to time. Any customer or user of this document or products described herein will assume all risks and liabilities associated with such use, and will hold Diodes and all companies whose products are represented herein or on Diodes’ websites, harmless against all damages and liabilities.
4. Products described herein may be covered by one or more United States, international or foreign patents and pending patent applications. Product names and markings noted herein may also be covered by one or more United States, international or foreign trademarks and trademark applications. Diodes does not convey any license under any of its intellectual property rights or the rights of any third parties (including third parties whose products and services may be described in this document or on Diodes’ website) under this document.
5. Diodes products are provided subject to Diodes’ Standard Terms and Conditions of Sale (<https://www.diodes.com/about/company/terms-and-conditions/terms-and-conditions-of-sales/>) or other applicable terms. This document does not alter or expand the applicable warranties provided by Diodes. Diodes does not warrant or accept any liability whatsoever in respect of any products purchased through unauthorized sales channel.
6. Diodes products and technology may not be used for or incorporated into any products or systems whose manufacture, use or sale is prohibited under any applicable laws and regulations. Should customers or users use Diodes products in contravention of any applicable laws or regulations, or for any unintended or unauthorized application, customers and users will (a) be solely responsible for any damages, losses or penalties arising in connection therewith or as a result thereof, and (b) indemnify and hold Diodes and its representatives and agents harmless against any and all claims, damages, expenses, and attorney fees arising out of, directly or indirectly, any claim relating to any noncompliance with the applicable laws and regulations, as well as any unintended or unauthorized application.
7. While efforts have been made to ensure the information contained in this document is accurate, complete and current, it may contain technical inaccuracies, omissions and typographical errors. Diodes does not warrant that information contained in this document is error-free and Diodes is under no obligation to update or otherwise correct this information. Notwithstanding the foregoing, Diodes reserves the right to make modifications, enhancements, improvements, corrections or other changes without further notice to this document and any product described herein. This document is written in English but may be translated into multiple languages for reference. Only the English version of this document is the final and determinative format released by Diodes.
8. Any unauthorized copying, modification, distribution, transmission, display or other use of this document (or any portion hereof) is prohibited. Diodes assumes no responsibility for any losses incurred by the customers or users or any third parties arising from any such unauthorized use.

Copyright © 2021 Diodes Incorporated

www.diodes.com

Looking for pricing, stock, or lifecycle information?

Click below to explore more details on WIN SOURCE:

-  [View DGD0590AFU-7 on WIN SOURCE](#)
-  [Diodes Incorporated Information](#)

Optimize Your Supply Chain with WIN SOURCE Solutions

-  Global Sourcing Solution
-  Obsolete Management
-  Cost Control Management
-  Shortage Management
-  Alternative Solution
-  Excess Inventory Management