



**THE DATASHEET OF  
DS1818R-5+T&R**



### BENEFITS AND FEATURES

- Improves Reliability of Processor Operation
  - Temperature-Compensated Voltage Monitor for Precise, Automated Power-Fail Detection
  - Automatically Restarts a Microprocessor After Power Failure
  - Maintains Reset for 150ms After  $V_{CC}$  Returns to Tolerance for Processor Stabilization
  - Monitors Pushbutton for External Override
  - Active-Low Reset Output
- Efficient Open-Drain Output with Internal 5.5k $\Omega$  Pullup Resistor Saves Power and Space
  - 35 $\mu$ A (max) Quiescent Current
- Allows for Easy Design with No Complicated Settings
  - Fixed 3.3V Reset Threshold
  - 5%, 10%, and 20% Tolerance Versions Available
- Operates in Most Commercial and Industrial Environments
  - -40°C to +85°C Operating Temperature Range
- MXD1818 Offers Improved Performance over the DS1818

### PIN ASSIGNMENT

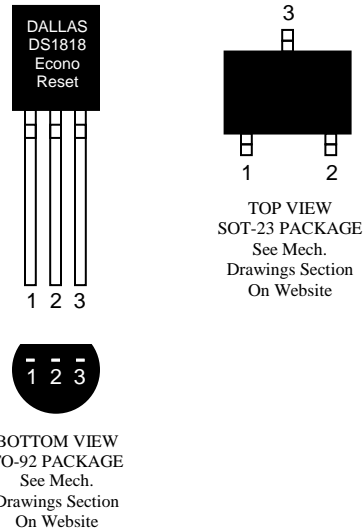

### PIN DESCRIPTION

#### TO-92

1	$\overline{RST}$	Active Low Reset Output
2	$V_{CC}$	Power Supply
3	GND	Ground

#### SOT-23

1	$\overline{RST}$	Active Low Reset Output
2	$V_{CC}$	Power Supply
3	GND	Ground

### DESCRIPTION

The DS1818 EconoReset uses a precision temperature-compensated reference and comparator circuit to monitor the status of the power supply ( $V_{CC}$ ). When an out-of-tolerance condition is detected, an internal power-fail signal is generated which forces reset to the active state. When  $V_{CC}$  returns to an in-tolerance condition, the reset signal is kept in the active state for approximately 150 ms to allow the power supply and processor to stabilize.

The DS1818 also monitors a pushbutton on the reset output. If the reset line is pulled low, a reset is generated upon release and the DS1818 output will be held in reset output low for typically 150 ms.

## OPERATION - POWER MONITOR

The DS1818 provides the functions of detecting out-of-tolerance power supply conditions and warning a processor-based system of impending power failures. When  $V_{CC}$  is detected as out-of-tolerance, the  $\overline{RST}$  signal is asserted. On power-up,  $\overline{RST}$  is kept active for approximately 150 ms after the power supply has reached the selected tolerance. This allows the power supply and microprocessor to stabilize before  $\overline{RST}$  is released.

## BLOCK DIAGRAM (OPEN-DRAIN OUTPUT) Figure 1

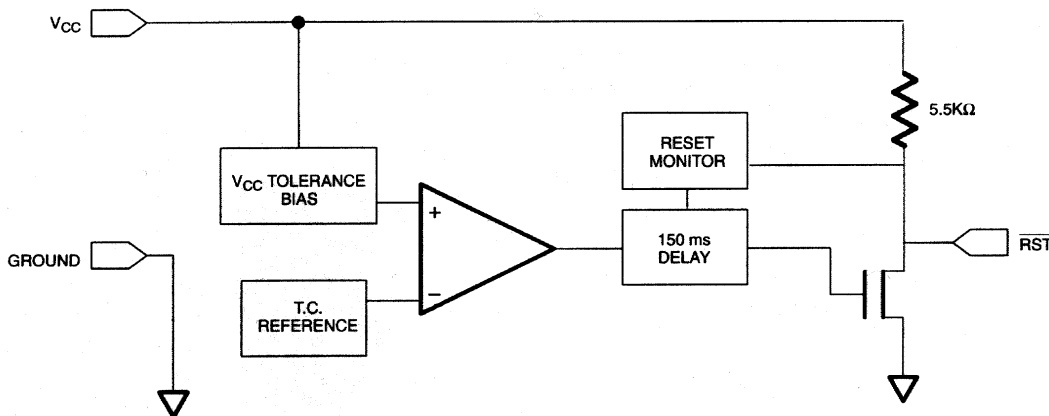

## APPLICATION EXAMPLE Figure 2

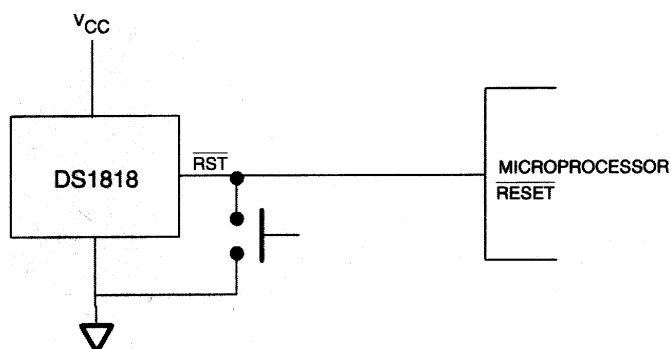

## OPERATION - PUSHBUTTON RESET

The DS1818 provides a pushbutton switch for manual reset control. When the DS1818 is not in a reset cycle, a pushbutton reset can be generated by pulling the  $\overline{RST}$  pin low for at least  $1\ \mu\text{s}$ . When the pushbutton is held low, the  $\overline{RST}$  is forced active low and will remain active low for about 150 ms after the pushbutton is released. See Figure 2 for an application example and Figure 3 for the timing diagram.

## TIMING DIAGRAM: PUSHBUTTON RESET Figure 3

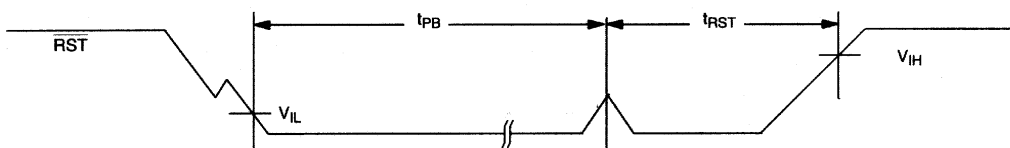

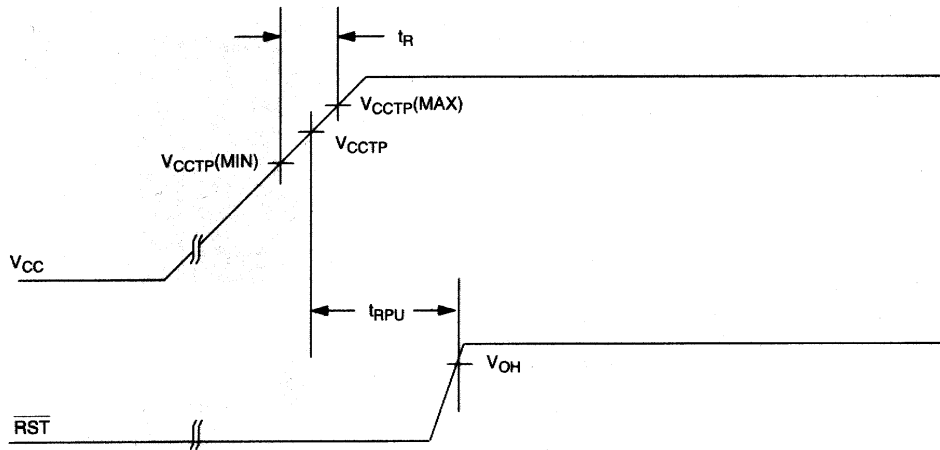
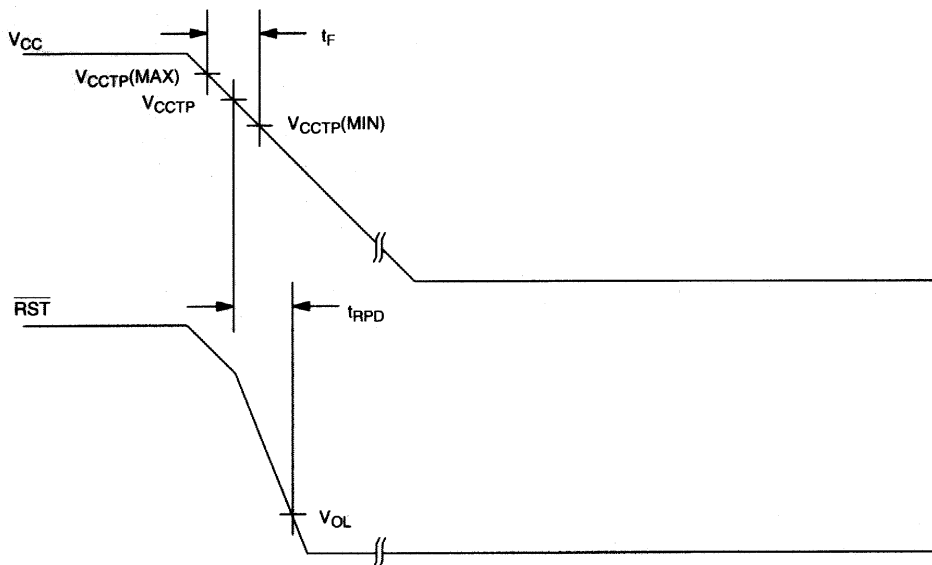
**TIMING DIAGRAM: POWER-UP** Figure 4**TIMING DIAGRAM: POWER-DOWN** Figure 5

**ABSOLUTE MAXIMUM RATINGS\***

Voltage on $\overline{V_{CC}}$ Pin Relative to Ground	-0.5V to +7.0V
Voltage on $\overline{RST}$ Relative to Ground	-0.5V to +5 $V_{CC}$ +0.5V
Operating Temperature	-40°C to +85°C
Storage Temperature	-55°C to +125°C
Soldering Temperature	260°C for 10 seconds

\* This is a stress rating only and functional operation of the device at these or any other conditions above those indicated in the operation sections of this specification is not implied. Exposure to absolute maximum rating conditions for extended periods of time may affect reliability.

**RECOMMENDED DC OPERATING CONDITIONS (-40°C to +85°C)**

PARAMETER	SYMBOL	MIN	TYP	MAX	UNITS	NOTES
Supply Voltage	$V_{CC}$	1.0		5.5	V	1

**DC ELECTRICAL CHARACTERISTICS (-40°C to +85°C;  $V_{CC}$ =1.2V to 5.5V)**

PARAMETER	SYMBOL	MIN	TYP	MAX	UNITS	NOTES
Output Current @ 0.4 V	$I_{OL}$	+10			mA	2, 3
Voltage Input Low	$V_{IL}$			0.4	V	1
Voltage Input High	$V_{IH}$	0.7 * $V_{CC}$			V	1
Operating Current $V_{CC} < 5.5V$	$I_{CC}$		28	35	$\mu A$	4
$V_{CC}$ Trip Point (DS1818-5)	$V_{CCTP}$	2.98	3.06	3.15	V	1
$V_{CC}$ Trip Point (DS1818-10)	$V_{CCTP}$	2.80	2.88	2.97	V	1
$V_{CC}$ Trip Point (DS1818-20)	$V_{CCTP}$	2.47	2.55	2.64	V	1
Internal Pull-up Resistor	$R_P$	3.50	5.5	7.5	k $\Omega$	7
Output Capacitance	$C_{OUT}$			10	pF	

**AC ELECTRICAL CHARACTERISTICS (-40°C to +85°C;  $V_{CC}$ =1.2V to 5.5V)**

PARAMETER	SYMBOL	MIN	TYP	MAX	UNITS	NOTES
RESET Active Time	$t_{RST}$	100	150	250	ms	5
$V_{CC}$ Detect to $\overline{RST}$	$t_{RPD}$		2	5	$\mu s$	
$V_{CC}$ Slew Rate ( $V_{CCTP}$ (MAX) to $V_{CCTP}$ (MIN))	$t_F$	300			$\mu s$	8
$V_{CC}$ Slew Rate ( $V_{CCTP}$ (MIN) to $V_{CCTP}$ (MAX))	$t_R$	0			ns	
$V_{CC}$ Detect to $\overline{RST}$	$t_{RPU}$	100	150	250	ms	5, 6
Pushbutton Detect to $\overline{RST}$	$t_{PB}$	1			$\mu s$	
Pushbutton Reset	$t_{PBRST}$	100	150	250	ms	5

**NOTES:**

1. All voltages are referenced to ground.
2. Measured with  $V_{CC} \geq 2.7V$ .
3. A  $1\text{ k}\Omega$  external pull-up resistor may be required in some applications for proper operation of the microprocessor reset control circuit.
4. Measured with  $\overline{\text{RST}}$  output open.
5. Measured with  $2.7V \leq V_{CC} \leq 3.3V$ .
6.  $t_R = 5\ \mu\text{s}$ .
7.  $V_{OH}$  and  $I_{OH}$  are a function of the value of  $R_P$  and the associated output load conditions.
8. The  $t_F$  value is for reference in defining values for  $t_{RPD}$  and should not be considered a requirement for proper operation or use of the device.

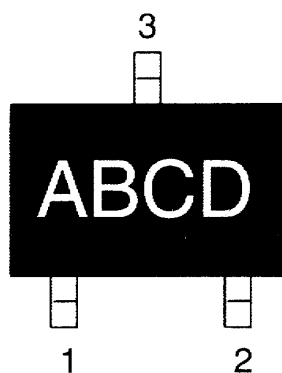
**PART MARKING CODES**

“A”, “B”, & “C” represent the device type.

810	-	DS1810
811	-	DS1811
812	-	DS1812
813	-	DS1813
815	-	DS1815
816	-	DS1816
817	-	DS1817
818	-	DS1818

“D” represents the device tolerance.

A	-	5%
B	-	10%
C	-	15%
D	-	20%

## REVISION HISTORY



REVISION NUMBER	REVISION DATE	DESCRIPTION	PAGES CHANGED
1	3/15	Updated <i>Benefits and Features</i> section	1

For pricing, delivery, and ordering information, please contact Maxim Direct at 1-888-629-4642, or visit Maxim Integrated's website at [www.maximintegrated.com](http://www.maximintegrated.com).

*Maxim Integrated cannot assume responsibility for use of any circuitry other than circuitry entirely embodied in a Maxim Integrated product. No circuit patent licenses are implied. Maxim Integrated reserves the right to change the circuitry and specifications without notice at any time. The parametric values (min and max limits) shown in the Electrical Characteristics table are guaranteed. Other parametric values quoted in this data sheet are provided for guidance.*

## Looking for pricing, stock, or lifecycle information?

Click below to explore more details on WIN SOURCE:

-  [View DS1818R-5+T&R on WIN SOURCE](#)
-  [Maxim Integrated Information](#)

## Optimize Your Supply Chain with WIN SOURCE Solutions

-  Global Sourcing Solution
-  Obsolete Management
-  Cost Control Management
-  Shortage Management
-  Alternative Solution
-  Excess Inventory Management