



**THE DATASHEET OF
AL3644CH12-7**



Description

The AL3644 is a dual LED flash driver that provides a high level of adjustability within a small solution size. The AL3644 utilizes a 2MHz or 4MHz fixed frequency synchronous boost converter to provide power to the dual 1.5A constant current LED sources. The dual 128 level current sources provide the flexibility to adjust the current ratios between LED1 and LED2. An adaptive regulation method ensures the current sources remain in regulation and maximizes efficiency.

Features of the AL3644 are controlled via an I²C-compatible interface. These features include: hardware flash and hardware torch pins (STROBE and TORCH/TEMP), a TX interrupt, and an NTC thermistor monitor. The device offers independently programmable currents in each output leg to drive the LEDs in a Flash or Movie Mode (Torch) condition.

The 2MHz or 4MHz switching frequency options, overvoltage protection (OVP), and adjustable current limit allow for the use of tiny, low-profile inductors and ceramic capacitors (10µF). The device operates over a -40°C to +85°C ambient temperature range.

Features

- Dual Independent 1.5A LED Current Source Programmability
- Accurate and Programmable LED Current Range from 1.4mA to 1.5A
- Torch Currents up to 360mA (AL3644TT)
- Flash Timeout Values up to 1.6 Seconds (AL3644TT)
- Optimized Flash LED Current During Low Battery Conditions (Input Voltage Flash Monitor)
- > 85% Efficiency in Torch Mode (at 100mA) and Flash Mode (at 1A to 1.5A)
- Grounded Cathode LED Operation for Improved Thermal Management
- Small Solution Size: < 2.36mm²
- Hardware Strobe Enable (STROBE)
- Synchronization Input for RF Power Amplifier Pulse Events (TX)
- Hardware Torch Enable (TORCH/TEMP)
- Remote NTC Monitoring (TORCH/TEMP)
- 400kHz I²C-Compatible Interface – AL3644 (I²C Address = 0x63)
- **Totally Lead-Free & Fully RoHS Compliant (Notes 1 & 2)**
- **Halogen and Antimony Free. “Green” Device (Note 3)**
- **For automotive applications requiring specific change control (i.e. parts qualified to AEC-Q100/101/104/200, PPAP capable, and manufactured in IATF 16949 certified facilities), please [contact us](mailto:contact@diodes.com) or your local Diodes representative. <https://www.diodes.com/quality/product-definitions/>**

Notes: 1. No purposely added lead. Fully EU Directive 2002/95/EC (RoHS), 2011/65/EU (RoHS 2) & 2015/863/EU (RoHS 3) compliant.
 2. See <https://www.diodes.com/quality/lead-free/> for more information about Diodes Incorporated's definitions of Halogen- and Antimony-free, "Green" and Lead-free.
 3. Halogen- and Antimony-free "Green" products are defined as those which contain <900ppm bromine, <900ppm chlorine (<1500ppm total Br + Cl) and <1000ppm antimony compounds.

Pin Assignment

Top View

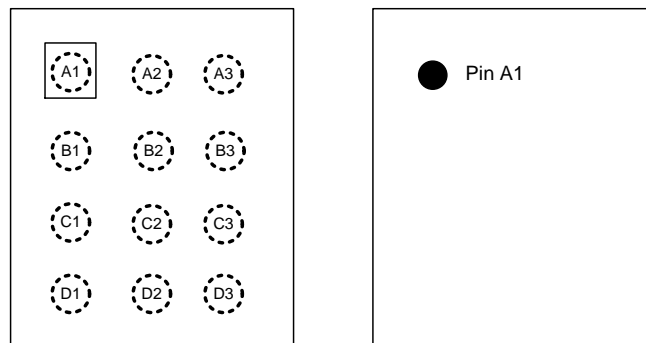

U-WLB1713-12

Applications

- Camera phone white LED flashes

Typical Applications Circuit

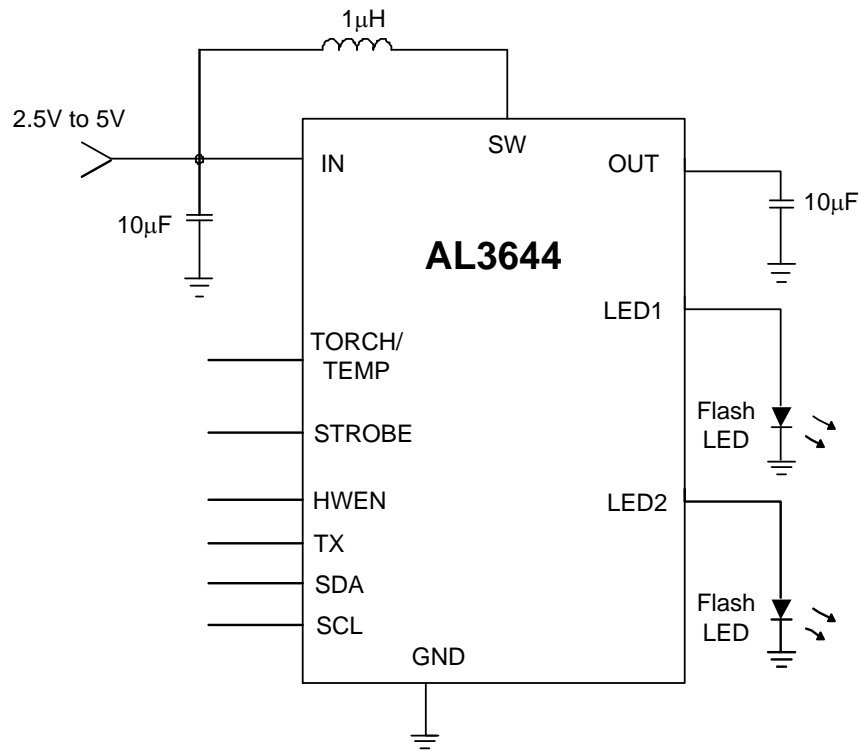

Pin Descriptions

Pin Number	Pin Name	Type	Function
A1	GND	Ground	Ground.
A2	IN	Power	Input voltage connection. Connect IN to the input supply and bypass to GND with a 10µF or larger ceramic capacitor.
A3	SDA	I/O	Serial data input/output in the I ² C mode on AL3644.
B1	SW	Power	Drain connection for internal nMOS and synchronous pMOS switches.
B2	STROBE	I/O	Active high hardware flash to enable. Drive STROBE high to turn on Flash pulse. Internal pulldown resistor of 300kΩ between STROBE and GND.
B3	SCL	I/O	Serial clock input for AL3644.
C1	OUT	Power	Step-up DC-DC converter output. Connect a 10µF ceramic capacitor between this pin and GND.
C2	HWEN	I/O	Active high enable pin. High = Standby, Low = Shutdown/Reset. Internal pulldown resistor of 300kΩ between HWEN and GND.
C3	TORCH/TEMP	I/O	Torch terminal input or threshold detector for NTC temperature sensing and current scale back.
D1	LED2	Power	High-side current source output for flash LED.
D2	TX	I/O	Configurable dual polarity power amplifier synchronization input. Internal pulldown resistor of 300kΩ between TX and GND.
D3	LED1	Power	High-side current source output for flash LED.

Functional Block Diagram

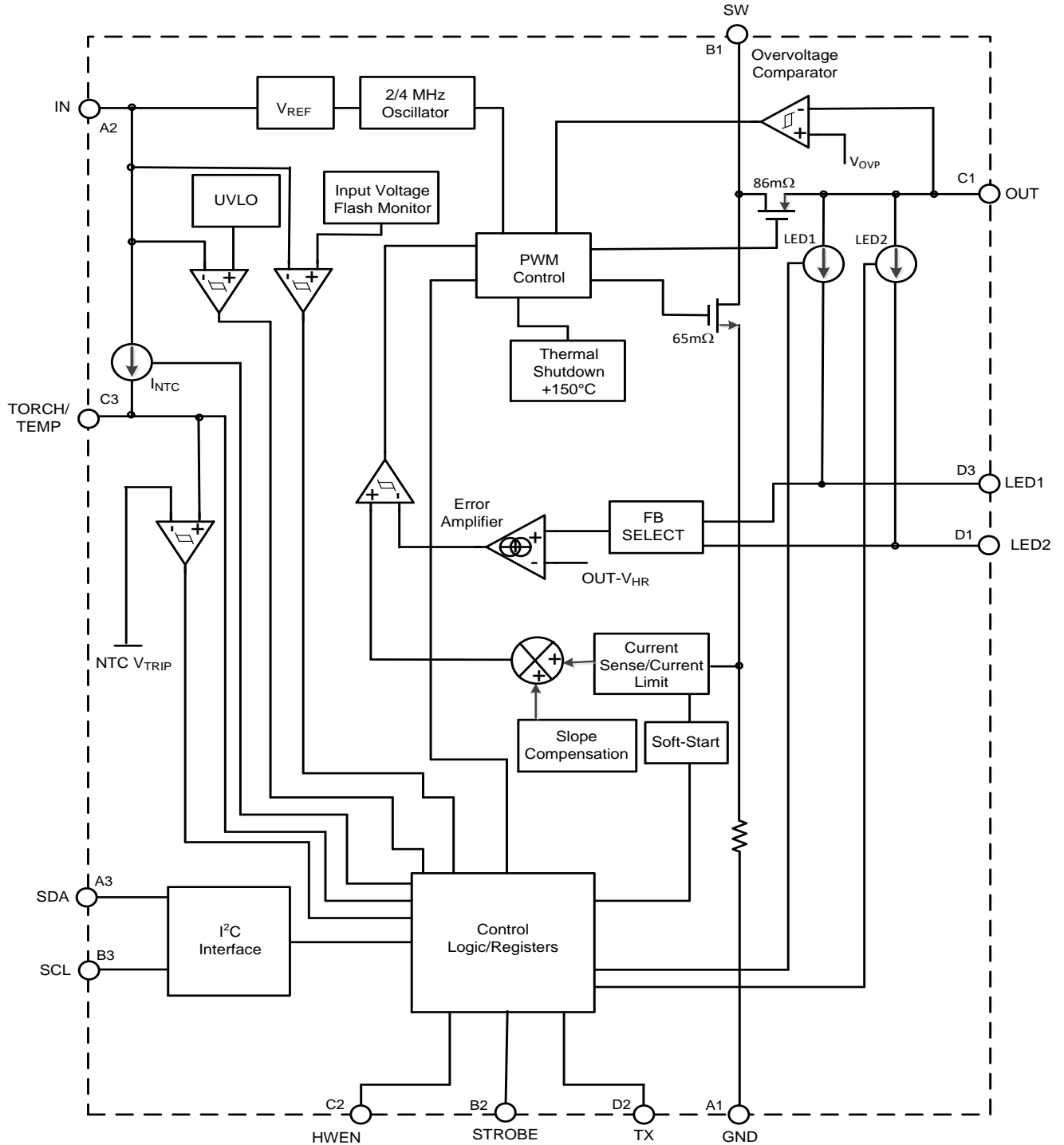

Absolute Maximum Ratings (@T_A = +25°C, unless otherwise specified.) (Note 4)

Symbol	Parameter	Rating	Unit
V _{IN} , V _{SW} , V _{OUT} , V _{LED1} , V _{LED2}	Voltage at Input Pins	-0.3 to 6	V
V _{SDA} , V _{SCL} , V _{TX} , V _{TORCH/TEMP} , V _{HWEN} , V _{STROBE}	V _{OUT} and SW Pin Voltage	-0.3 to the Lesser of (V _{IN} +0.3)V / 6V	V
θ _{JA}	Junction-to-Ambient Thermal Resistance (Note 5)	201.5	°C/W
θ _{JC}	Junction-to-Case Thermal Resistance (Note 5)	46.6	°C/W
T _J	Operating Junction Temperature	+150	°C
T _{STG}	Storage Temperature	-65 to +150	°C
ESD	HBM	2000	V
	CDM	1500	V

- Notes:
- Stresses greater than those listed under *Absolute Maximum Ratings* can cause permanent damage to the device. These are stress ratings only, and functional operation of the device at these or any other conditions beyond those indicated under *Recommended Operating Conditions* is not implied. Exposure to *Absolute Maximum Ratings* for extended periods can affect device reliability.
 - Device mounted on FR-4 substrate PC board (1" x 1"), with minimum recommended pad layout.

Recommended Operating Conditions (@T_A = +25°C, unless otherwise specified.)

Symbol	Parameter	Min	Max	Unit
V _{IN}	Input Voltage	2.5	5.0	V
T _A	Operating Ambient Temperature	-40	+85	°C
T _J	Operating Junction Temperature	-40	+125	°C

Electrical Characteristics ($V_{IN} = 3.6V$, $V_{HWEN} = V_{IN}$, $T_A = +25^\circ C$, unless otherwise specified.)

Symbol	Parameter	Conditions	Min	Typ	Max	Unit
CURRENT SOURCE						
$I_{LED1/2}$	Current Source Accuracy	$V_{OUT} = 4V$ Flash Code = 0x7F = 1.5A Flash	1.395 -7%	1.5 —	1.605 7%	A
		$V_{OUT} = 4V$ Torch Code = 0x3F = 89.3mA Torch	80.37 -10%	89.3 —	98.23 10%	mA
$I_{LED1/2}$	Current Source Accuracy (AL3644TT)	$V_{OUT} = 4V$ Torch Code = 0x3F = 180mA Torch	162 -10%	180 —	198 10%	mA
V_{HR}	LED1 and LED2 Current Source Regulation Voltage	$I_{LED1/2} = 729mA$ Flash	—	290	—	mV
		$I_{LED1/2} = 179mA$ Torch	—	158	—	mV
V_{HR}	LED1 and LED2 Current Source Regulation Voltage (AL3644TT)	$I_{LED1/2} = 360mA$ Torch and Flash	—	270	—	mV
V_{OVP}	Overvoltage Protection Threshold	On Threshold	4.60	4.75	4.85	V
		Off Threshold	—	4.65	—	V
STEP-UP DC/DC CONVERTER						
I_Q	Quiescent Supply Current	Device not Switching Pass Mode	—	0.3	0.75	mA
I_{SD}	Shutdown Supply Current	Device Disabled, $V_{HWEN} = 0V$ $2.5V \leq V_{IN} \leq 5V$	—	0.1	4	μA
I_{SB}	Standby Supply Current	Device Disabled, $V_{HWEN} = 1.8V$ $2.5V \leq V_{IN} \leq 5V$	—	2.5	10	μA
f_{SW}	Switching Frequency	$2.5V \leq V_{IN} \leq 5V$	3.76	4	4.24	MHz
			-6%	—	6%	
R_{PMOS}	PMOS Switch On-Resistance	$V_{IN} = 3.6V$	—	86	—	m Ω
R_{NMOS}	NMOS Switch On-Resistance	$V_{IN} = 3.6V$	—	65	—	m Ω
I_{CL}	Switch Current Limit	Reg 0x07, bit[0] = 0	1.672	1.9	2.128	A
			-12%	—	12%	
		Reg 0x07, bit[0] = 1	2.464	2.8	3.136	
			-12%	—	12%	
$UVLO$	Undervoltage Lockout Threshold	Falling V_{IN}	—	2.5	2.6	V
V_{TRIP}	NTC Comparator Trip Threshold	Reg 0x09, bits[3:1] = '100'	0.57	0.60	0.63	V
			-5%	—	5%	
I_{NTC}	NTC Current	—	47	50	53	μA
			-6%	50	6%	
V_{IVFM}	Input Voltage Flash Monitor Trip Threshold	Reg 0x02, bits[5:3] = '000'	2.813	2.9	2.987	V
			-3%	—	3%	
HWEN, TORCH/TEMP, STROBE, TX VOLTAGE						
V_{IL}	Input Logic Low	$2.5V \leq V_{IN} \leq 5V$	0	—	0.4	V
V_{IH}	Input Logic High		1.2	—	V_{IN}	V
I²C-COMPATIBLE INTERFACE (SCL, SDA)						
V_{IL}	Input Logic Low	$2.5V \leq V_{IN} \leq 4.2V$	0	—	0.4	V
V_{IH}	Input Logic High		1.2	—	V_{IN}	V
V_{OL}	Output Logic Low	$I_{LOAD} = 3mA$	—	—	400	mV

Electrical Characteristics ($V_{IN} = 3.6V$, $V_{HWEN} = V_{IN}$, $T_A = +25^\circ C$, unless otherwise specified.) (continued)

Symbol	Parameter	Conditions	Min	Typ	Max	Unit
TIMING REQUIREMENTS						
t_1	SCL Clock Period	—	2.4	—	—	μs
t_2	Data In Setup Time to SCL High	—	100	—	—	ns
t_3	Data Out Stable After SCL Low	—	0	—	—	ns
t_4	SDA Low Setup Time to SCL Low (Start)	—	100	—	—	ns
t_5	SDA High Hold Time After SCL High (Stop)	—	100	—	—	ns

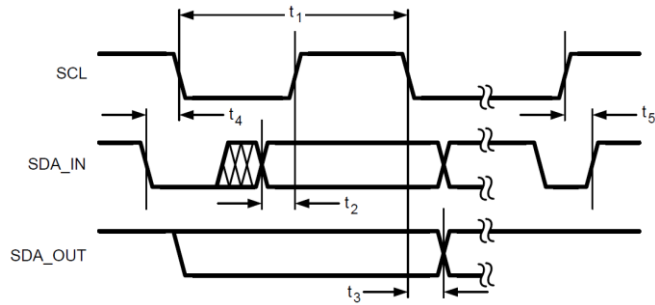
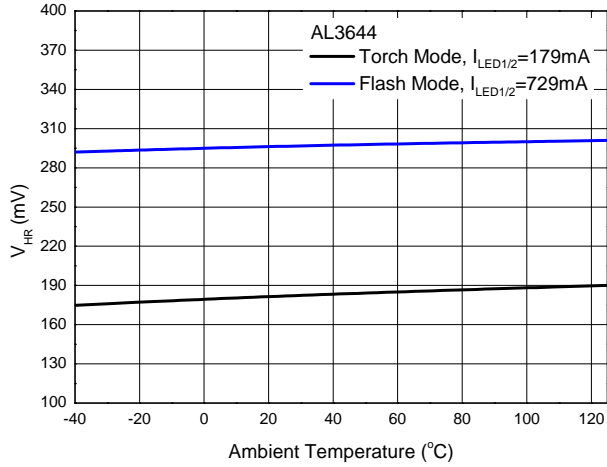

Figure 1. I²C-Compatible Interface Specifications

Typical Performance Characteristics

(@ $T_A = +25^\circ\text{C}$, $V_{IN} = 3.6\text{V}$, $V_{HWEN} = V_{IN}$, $C_{IN} = 2 \times 10\mu\text{F}$, $C_{OUT} = 2 \times 10\mu\text{F}$ and $L = 1\mu\text{H}$, unless otherwise specified.)

Current Source Regulation Voltage vs. Temperature



Current Source Regulation Voltage vs. Temperature

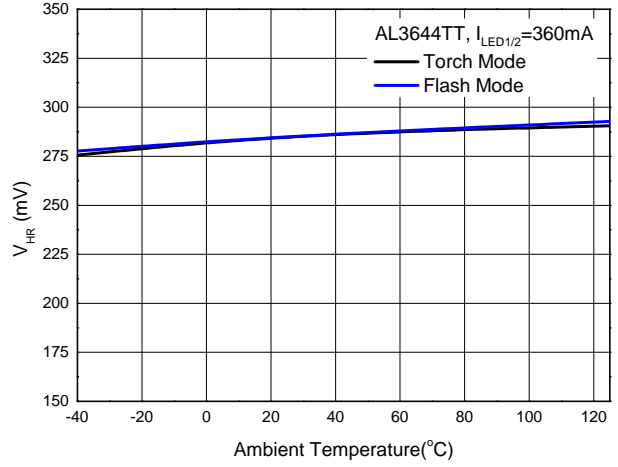

NTC Comparator Trip Threshold vs. Temperature

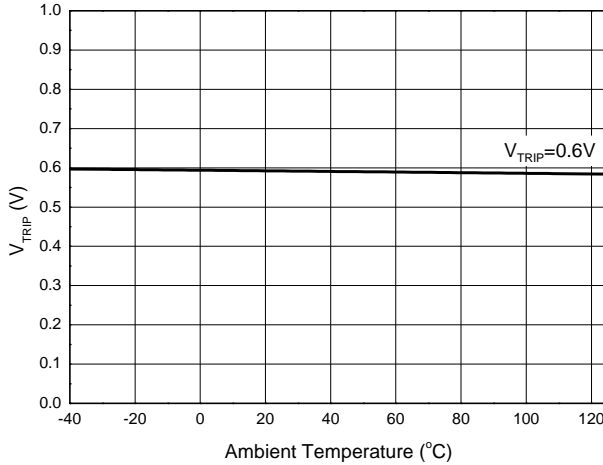

Overvoltage Protection Threshold vs. Temperature

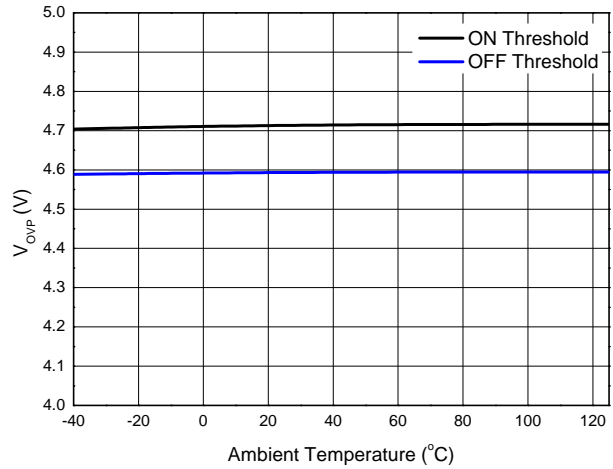

Undervoltage Lockout Threshold vs. Temperature

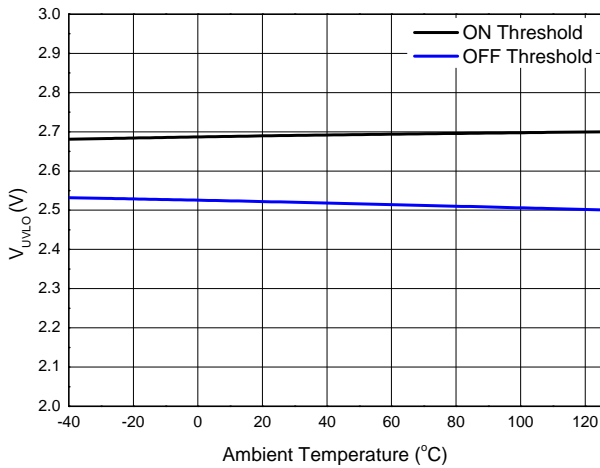

Input Voltage Flash Monitor Trip Threshold vs. Temperature

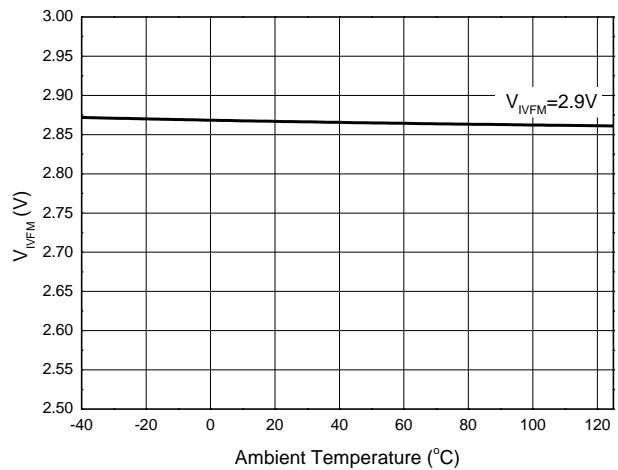

Typical Performance Characteristics (continued)

(@ $T_A = +25^\circ\text{C}$, $V_{IN} = 3.6\text{V}$, $V_{HWEN} = V_{IN}$, $C_{IN} = 2 \times 10\mu\text{F}$, $C_{OUT} = 2 \times 10\mu\text{F}$ and $L = 1\mu\text{H}$, unless otherwise specified.)

Switching Frequency vs. Temperature

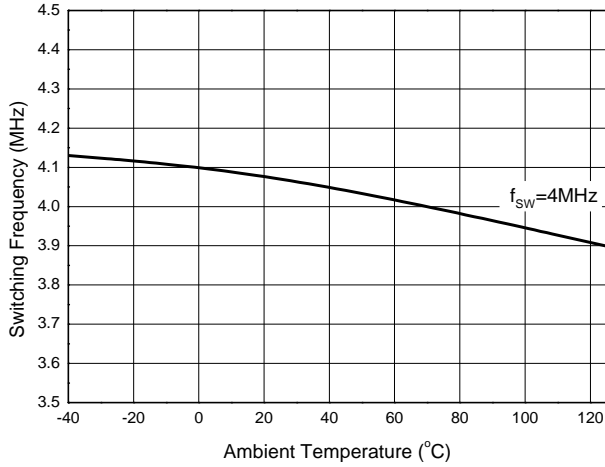

NTC Current vs. Temperature

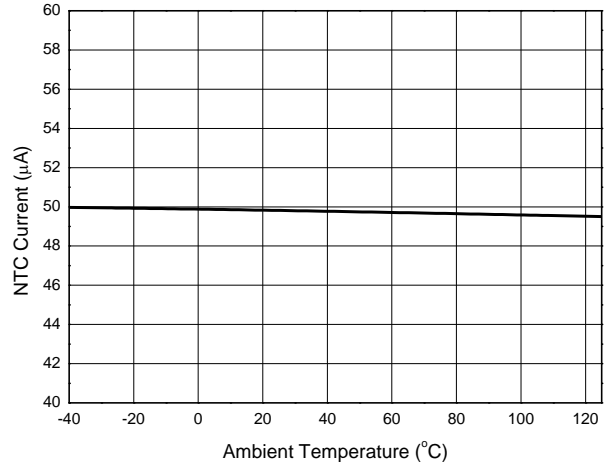

Inductor Current Limit 1 vs. Temperature

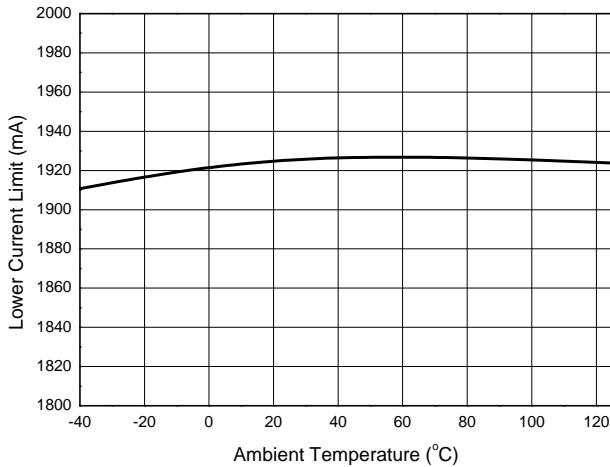

Inductor Current Limit 2 vs. Temperature

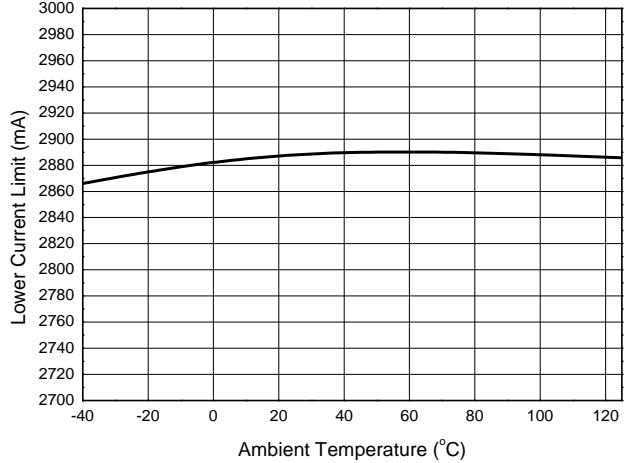

Standby Supply Current vs. Temperature

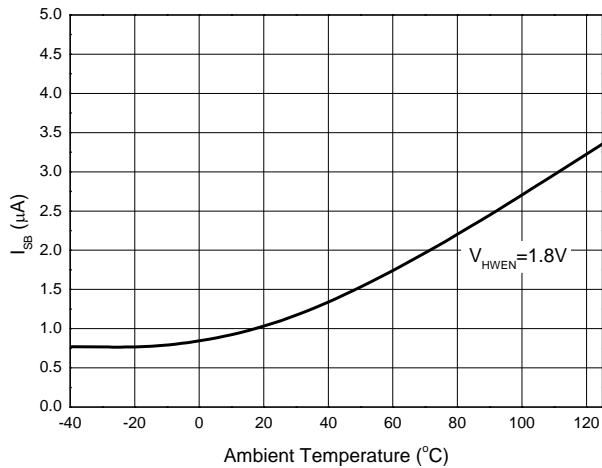

Quiescent Supply Current vs. Temperature

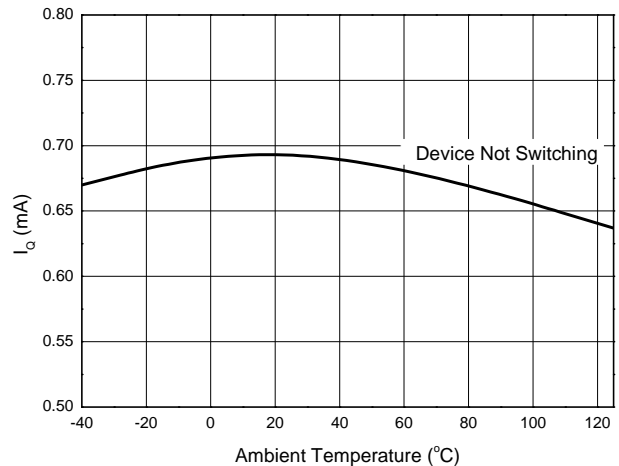

Typical Performance Characteristics (continued)

(@ $T_A = +25^\circ\text{C}$, $V_{IN} = 3.6\text{V}$, $V_{HWEN} = V_{IN}$, $C_{IN} = 2 \times 10\mu\text{F}$, $C_{OUT} = 2 \times 10\mu\text{F}$ and $L = 1\mu\text{H}$, unless otherwise specified.)

Shutdown Supply Current vs. Temperature

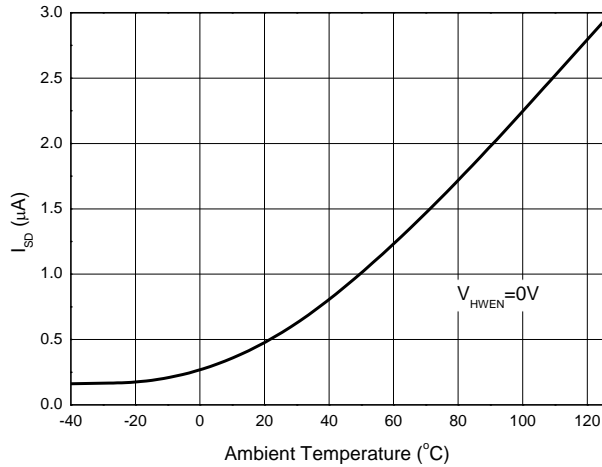

LED Torch Current vs. Temperature

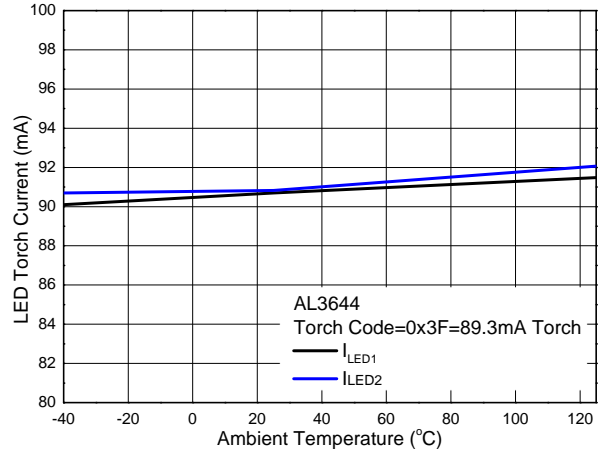

LED Torch Current vs. Temperature

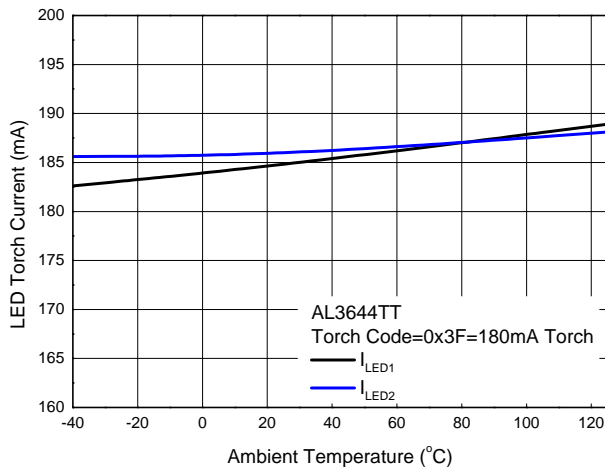

LED Flash Current vs. Temperature

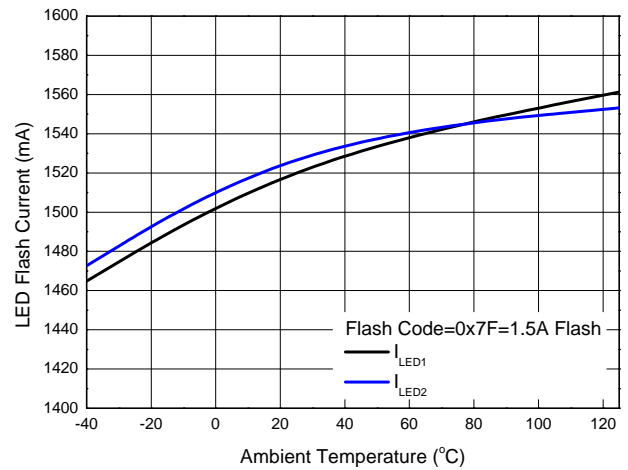

LED Torch Current vs. Brightness Code

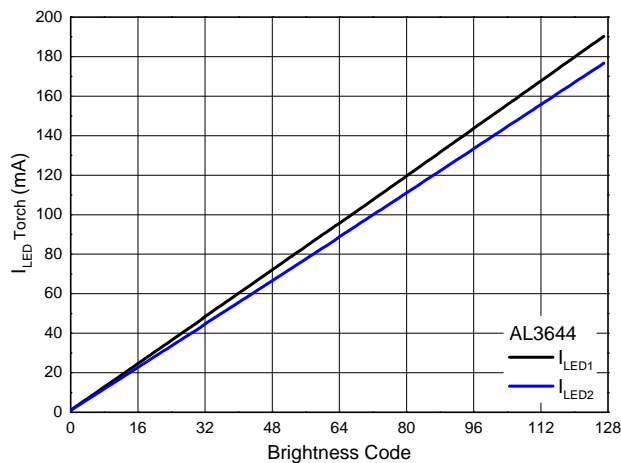

LED1 Torch Current vs. Input Voltage

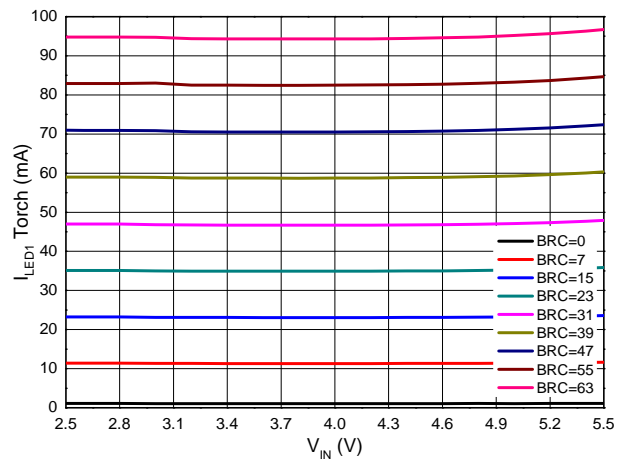

Typical Performance Characteristics (continued)

(@T_A = +25°C, V_{IN} = 3.6V, V_{HWEN} = V_{IN}, C_{IN} = 2 x 10μF, C_{OUT} = 2 x 10μF and L = 1μH, unless otherwise specified.)

LED2 Torch Current vs. Input Voltage

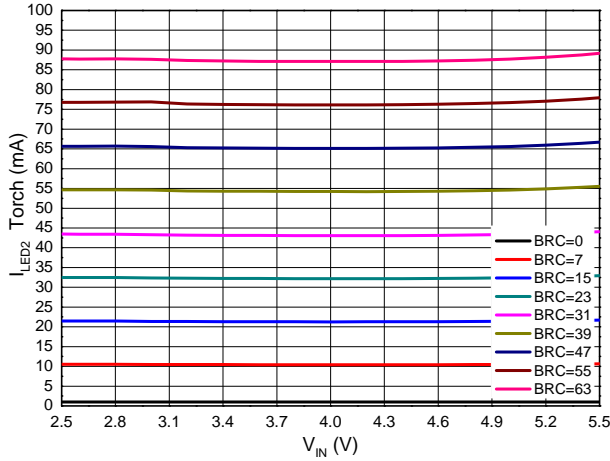

LED Torch Current vs. Input Voltage

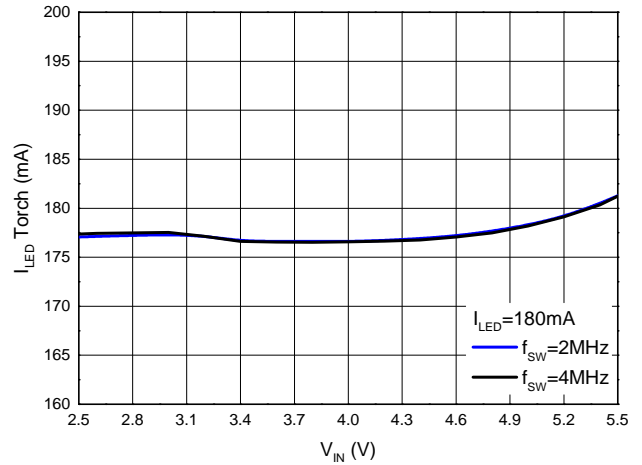

LED Efficiency vs. Input Voltage

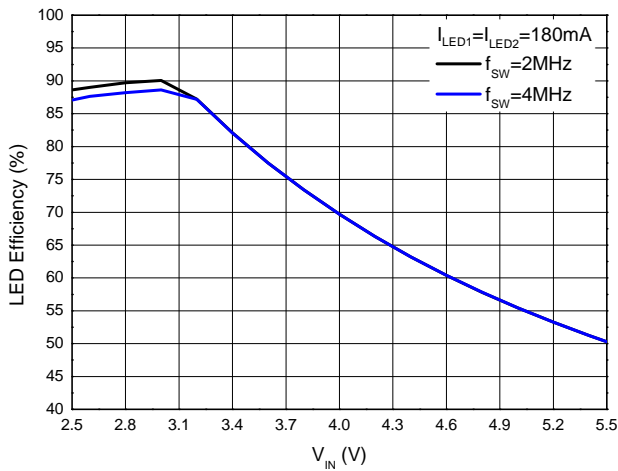

Application Information

1. General Operation

The AL3644 is a high-power white LED flash driver capable of delivering up to 1.5A in either of the two parallel LEDs. The device incorporates a 2MHz or 4MHz constant frequency-synchronous current-mode PWM boost converter and dual high-side current sources to regulate the LED current over the 2.5V to 5V input voltage range.

The AL3644 PWM DC-DC boost converter switches and boosts the output to maintain at least V_{HR} across each of the current sources (LED1/2). This minimum headroom voltage ensures that both current sources remain in regulation. If the input voltage is above the LED voltage plus current source headroom voltage, the device does not switch, but turns the pFET on continuously (Pass mode). In Pass mode the difference between ($V_{IN} - I_{LED} \times R_{PMOS}$) and the voltage across the LED is dropped across the current source.

The AL3644 has three logic inputs including a hardware Flash Enable (STROBE), a hardware Torch Enable (TORCH/TEMP, TORCH = default), and a Flash Interrupt input (TX) designed to interrupt the flash pulse during high battery-current conditions. These logic inputs have internal 300k Ω (typical) pulldown resistors to GND.

Additional features of the AL3644 include an internal comparator for LED thermal sensing via an external NTC thermistor and an input voltage monitor that can reduce the Flash current during low V_{IN} conditions. It also has a Hardware Enable (HWEN) pin that can be used to reset the state of the device and the registers by pulling the HWEN pin to ground.

Control is done via an I²C-compatible interface. This includes adjustment of the Flash and Torch current levels, changing the Flash Timeout Duration, and changing the switch current limit. Additionally, there are flag and status bits that indicate flash current timeout, LED overtemperature condition, LED failure (open/short), device thermal shutdown, TX interrupt, and V_{IN} undervoltage conditions.

2. Feature Description

2.1 Flash Mode

In Flash Mode, the LED current sources (LED1/2) provide 128 target current levels from 10.9mA to 1500mA. Once the Flash sequence is activated the current source (LED) ramps up to the programmed Flash current by stepping through all current steps until the programmed current is reached. The headroom in the two current sources can be regulated to provide 10.9mA to 1.5A on each of the two output pins. There is an option in the register settings to keep the two currents in the output pins the same.

When the device is enabled in Flash Mode through the Enable Register, all mode bits in the Enable Register are cleared after a flash timeout event.

2.2 Torch Mode

In Torch mode, the LED current sources (LED1/2) provide 128 target current levels from 0.977mA to 179mA or 1.954mA to 360mA on AL3644TT. The Torch currents are adjusted via the LED1 and LED2 LED Torch Brightness Registers. Torch mode is activated by the Enable Register (setting M1, M0 to '10'), or by pulling the TORCH/TEMP pin HIGH when the pin is enabled (Enable Register) and set to Torch Mode. Once the TORCH sequence is activated, the active current sources (LED1/2) ramps up to the programmed Torch current by stepping through all current steps until the programmed current is reached. The rate at which the current ramps is determined by the value chosen in the Timing Register.

Torch Mode is not affected by Flash Timeout or by a TX Interrupt event.

When the AL3644 enters standby mode, it shuts down all internal analog blocks to save power. To enter Torch mode from standby, the proper sequence is to first issue an I2C command to enter IR mode (Mode Bits = <01>), wait a few milliseconds, then enter Torch mode.

Application Information (continued)

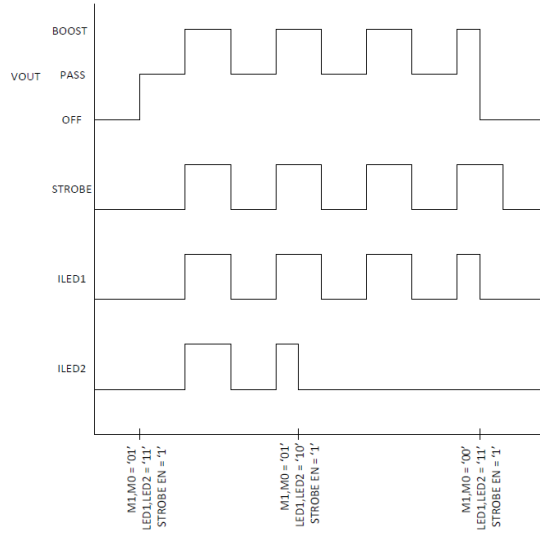

Figure 2. IR Mode with Boost

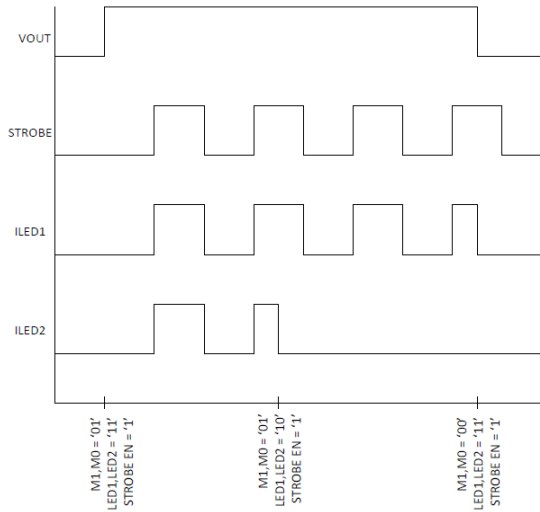

Figure 3. IR Mode Pass Only

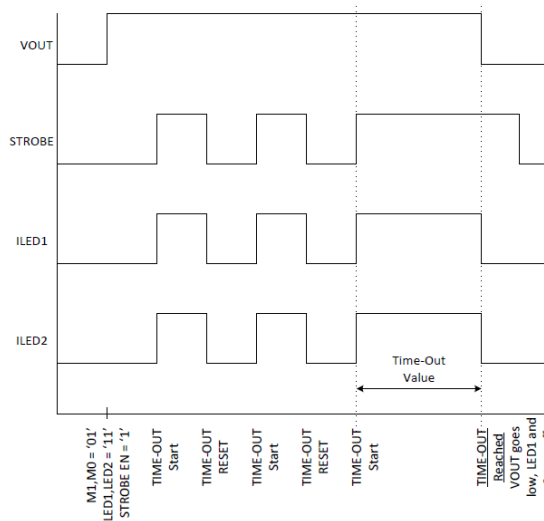

Figure 4. IR Mode Timeout

Application Information (continued)

2.3 IR Mode

In IR Mode, the target LED current is equal to the value stored in the LED1/2 Flash Brightness Registers. When the IR mode is enabled (setting M1, M0 to '01'), the boost converter turns on and sets the output equal to the input (pass-mode). At this point, toggling the STROBE pin enables and disables the LED1/2 current sources (if enabled). The strobe pin can only be set to be Level sensitive, meaning all timing of the IR pulse is externally controlled. In IR Mode, the current sources do not ramp the LED outputs to the target. The current transitions immediately from off to on and then on to off.

2.4 Standby Mode

When the device enters "Standby Mode", it shuts down all the internal analog blocks including bandgap reference voltage and SYNC booster converter to save power. When the device wakes up from standby mode into active mode, it needs a proper power-up sequence and some delay to stable power blocks before customer turns on "Torch Mode" thru I2C command.

3. Device Functioning Modes

3.1 Startup (Enabling the Device)

Turning on of the AL3644 Torch and Flash modes can be done through the Enable Register. On startup, when V_{OUT} is less than V_{IN} the internal synchronous pFET turns on as a current source and delivers 200mA (typical) to the output capacitor. During this time the current source (LED) is off. When the voltage across the output capacitor reaches 2.2V (typical) the current source turns on. At turn-on the current source steps through each FLASH or TORCH level until the target LED current is reached. This gives the device a controlled turn-on and limits the inrush current from the V_{IN} supply.

3.2 Pass Mode

The AL3644 starts up in Pass Mode and stays there until Boost Mode is needed to maintain regulation. If the voltage difference between V_{OUT} and V_{LED} falls below V_{HR} , the device switches to Boost Mode. In Pass Mode the boost converter does not switch, and the synchronous pMOS turns fully on bringing V_{OUT} up to $V_{IN} - I_{LED} \times R_{PMOS}$. In Pass Mode the inductor current is not limited by the peak current limit.

3.3 Power Amplifier Synchronization (TX)

The TX pin is a Power Amplifier Synchronization input. This is designed to reduce the flash LED current and thus limit the battery current during high battery current conditions such as PA transmit events. When the AL3644 is engaged in a Flash event, and the TX pin is pulled high, the LED current is forced into Torch Mode at the programmed Torch current setting. If the TX pin is then pulled low before the Flash pulse terminates, the LED current returns to the previous Flash current level. At the end of the Flash timeout, whether the TX pin is high or low, the LED current turns off.

3.4 Input Voltage Flash Monitor (IVFM)

The AL3644 has the ability to adjust the flash current based upon the voltage level present at the IN pin utilizing the Input Voltage Flash Monitor (IVFM). The adjustable threshold IVFM-D ranges from 2.9V to 3.6V in 100mV steps, with three different usage modes (Stop and Hold, Adjust Down Only, Adjust Up and Down). The Flags2 Register has the IVFM flag bit set when the input voltage crosses the IVFM-D value. Additionally, the IVFM-D threshold sets the input voltage boundary that forces the AL3644 to either stop ramping the flash current during startup (Stop and Hold Mode) or to start decreasing the LED current during the flash (Down Adjust Only and Up and Down Adjust). In Adjust Up and Down mode, the IVFM-D value plus the hysteresis voltage threshold set the input voltage boundary that forces the AL3644 to start ramping the flash current back up towards the target.

Application Information (continued)

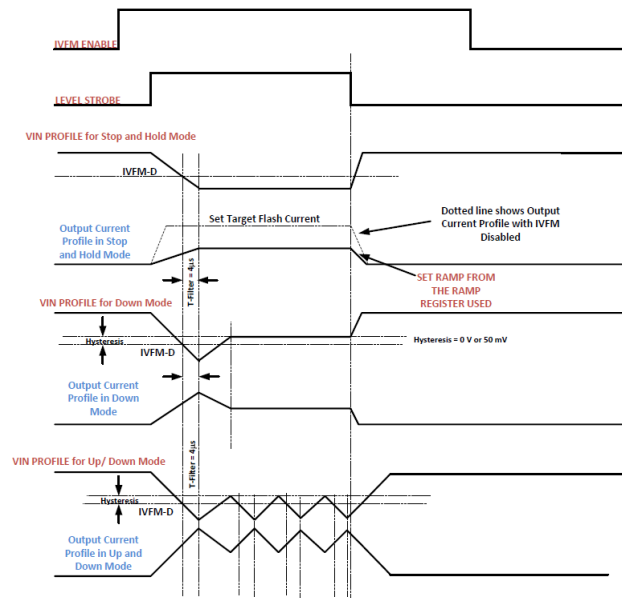

Figure 5. IVFM Modes

3.5 Fault/Protections

3.5.1 Fault Operation

If the AL3644 enters a fault condition, the device sets the appropriate flag in the Flags1 and Flags2 Registers (0x0A and 0x0B), and place the device into standby by clearing the Mode Bits ([1],[0]) in the Enable Register. The AL3644 remains in standby until an I²C read of the Flags1 and Flags2 Registers are completed. Upon clearing the flags/faults, the device can be restarted (Flash, Torch, IR, etc.). If the fault is still present, the AL3644 re-enters the fault state and enters standby again.

3.5.2 Flash Timeout

The Flash Timeout period sets the amount of time that the Flash Current is being sourced from the current sources (LED1/2). The AL3644 has 16 timeout levels ranging from 10ms to 400ms or 40ms to 1.6s on AL3644TT (see Timing Configuration Register (0x08) for more details).

3.5.3 Overvoltage Protection (OVP)

The output voltage is limited to typically 4.75V (see V_{OVP} spec in the *Electrical Characteristics*). In situations such as an open LED, the AL3644 raises the output voltage in order to try and keep the LED current at its target value. When V_{OUT} reaches 4.75V (typical) the overvoltage comparator trips and turns off the internal nFET. When V_{OUT} falls below the "V_{ovp} Off Threshold", the AL3644 begins switching again. The mode bits are cleared, and the OVP flag is set, when an OVP condition is present for three rising OVP edges. This prevents momentary OVP events from forcing the device to shut down.

3.5.4 Current Limit

The AL3644 features two selectable inductor current limits that are programmable through the I²C-compatible interface. When the inductor current limit is reached, the AL3644 terminates the charging phase of the switching cycle. Switching resumes at the start of the next switching period. If the overcurrent condition persists, the device operates continuously in current limit.

Since the current limit is sensed in the nMOS switch, there is no mechanism to limit the current when the device operates in Pass mode (current does not flow through the nMOS in Pass mode). In Boost mode or Pass mode if V_{OUT} falls below 2.3V, the device stops switching, and the pFET operates as a current source limiting the current to 200mA. This prevents damage to the AL3644 and excessive current draw from the battery during output short-circuit conditions. The mode bits are not cleared upon a Current Limit event, but a flag is set.

Application Information (continued)

3.5.5 NTC Thermistor Input (TORCH/TEMP)

The TORCH/TEMP pin, when set to TEMP mode, serves as a threshold detector and bias source for negative temperature coefficient (NTC) thermistors. When the voltage at TEMP goes below the programmed threshold, the AL3644 is placed into standby mode. The NTC threshold voltage is adjustable from 200mV to 900mV in 100mV steps. The NTC bias current is set to 50 μ A. The NTC detection circuitry can be enabled or disabled via the Enable Register. If enabled, the NTC block turns on and off during the start and stop of a Flash/Torch event.

Additionally, the NTC input looks for an open NTC connection and a shorted NTC connection. If the NTC input falls below 100mV, the NTC short flag is set, and the device is disabled. If the NTC input rises above 2.3V, the NTC Open flag is set, and the device is disabled. These fault detections can be individually disabled/enabled via the NTC Open Fault Enable bit and the NTC Short Fault Enable bit.

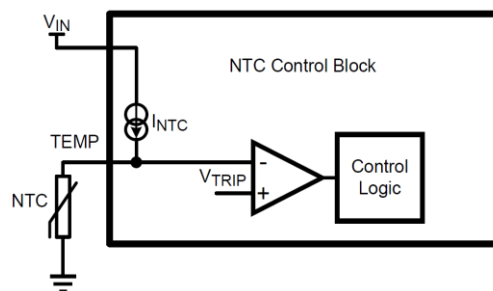

Figure 6. Temp Detection Diagram

3.5.6 Undervoltage Lockout (UVLO)

The AL3644 has an internal comparator that monitors the voltage at IN and forces the AL3644 into standby if the input voltage drops to 2.5V. If the UVLO monitor threshold is tripped, the UVLO flag bit is set in the Flags1 Register (0x0A). If the input voltage rises above 2.5V, the AL3644 is not available for operation until there is an I²C read of the Flags1 Register (0x0A). Upon a read, the Flags1 register is cleared, and normal operation can resume if the input voltage is greater than 2.5V.

3.5.7 Thermal Shutdown (TSD)

When the AL3644 die temperature reaches +150°C, the thermal shutdown detection circuit trips, forcing the AL3644 into standby and writing a '1' to the corresponding bit of the Flags1 Register (0x0A) (Thermal Shutdown bit). The AL3644 is only allowed to restart after the Flags1 Register (0x0A) is read, clearing the fault flag. Upon restart, if the die temperature is still above +150°C, the AL3644 resets the Fault flag and re-enters standby.

3.5.8 LED and/or V_{OUT} Short Fault

The LED Fault flags read back a '1' if the device is active in Flash or Torch mode and either active LED output experiences a short condition. The Output Short Fault flag reads back a '1' if the device is active in Flash or Torch mode and the boost output experiences a short condition. An LED short condition is determined if the voltage at LED1 or LED2 goes below 500mV (typical) while the device is in Torch or Flash mode. There is a deglitch time of 256 μ s before the LED Short flag is valid and a deglitch time of 2.048ms before the V_{OUT} Short flag is valid. The LED Short Faults can be reset to '0' by removing power to the AL3644, setting HWEN to '0', setting the SW RESET bit to a '1', or by reading back the Flags1 Register (0x0A on AL3644). The mode bits are cleared upon an LED and/or V_{OUT} short fault.

Application Information (continued)

4. Programming

4.1 Control Truth Table

Mode 1	Mode 0	Strobe EN	Torch EN	Strobe Pin	Torch Pin	Action
0	0	0	0	X	X	Standby
0	0	0	1	X	Pos Edge	Ext Torch
0	0	1	0	Pos Edge	X	Ext Flash
0	0	1	1	0	Pos Edge	Standalone Torch
0	0	1	1	Pos Edge	0	Standalone Flash
0	0	1	1	Pos Edge	Pos Edge	Standalone Flash
1	0	X	X	X	X	Int Torch
1	1	X	X	X	X	Int Flash
0	1	0	X	X	X	IRLED Standby
0	1	1	X	0	X	IRLED Standby
0	1	1	X	Pos Edge	X	IRLED Enabled

4.2 I²C-Compatible Interface

4.2.1 Data Validity

The data on SDA must be stable during the HIGH period of the clock signal (SCL). In other words, the state of the data line can only be changed when SCL is LOW.

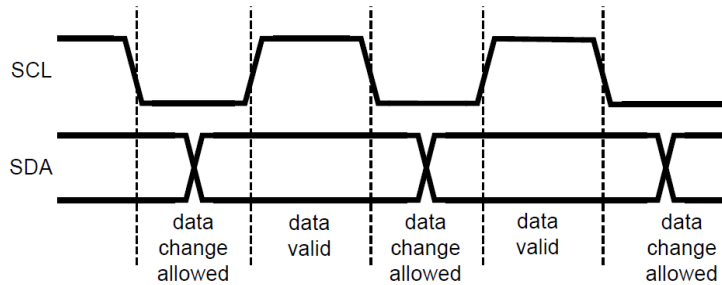

Figure 7. Data Validity Data

A pullup resistor between the controller's VIO line and SDA must be greater than $[(VIO - VOL) / 3mA]$ to meet the VOL requirement on SDA. Using a larger pullup resistor results in lower switching current with slower edges, while using a smaller pullup results in higher switching currents with faster edges.

Application Information (continued)

4.2.2 Start and Stop Conditions

The START and STOP conditions classify the beginning and the end of the I²C session. A START condition is defined as the SDA signal transitioning from HIGH to LOW while SCL line is HIGH. A STOP condition is defined as the SDA transitioning from LOW to HIGH while SCL is HIGH. The I²C master always generates the START and STOP conditions. The I²C bus is considered busy after a START condition and free after a STOP condition.

During data transmission, the I²C master can generate repeated START conditions. First START and repeated START conditions are equivalent, function-wise.

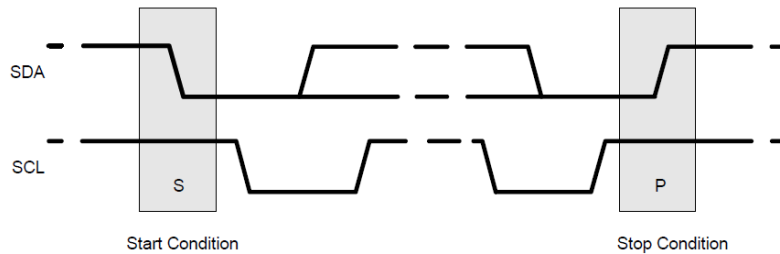

Figure 8. Start and Stop Conditions

4.2.3 Transferring Data

Every byte put on the SDA line must be eight bits long, with the Most Significant Bit (MSB) transferred first. Each byte of data has to be followed by an acknowledge bit. The acknowledgement related clock pulse is generated by the master. The master releases the SDA line (HIGH) during the acknowledge clock pulse. The AL3644 pulls down the SDA line during the 9th clock pulse, signifying an acknowledgement. The AL3644 generates an acknowledgement after each byte is received. There is no acknowledge created after data is read from the device.

After the START condition, the I²C master sends a chip address. This address is seven bits long followed by an eighth bit which is a data direction bit (R/W). The AL3644 7-bit address is 0x63. For the eighth bit, a '0' indicates a WRITE and a '1' indicates a READ. The second byte selects the register to which the data is written. The third byte contains data to write to the selected register.

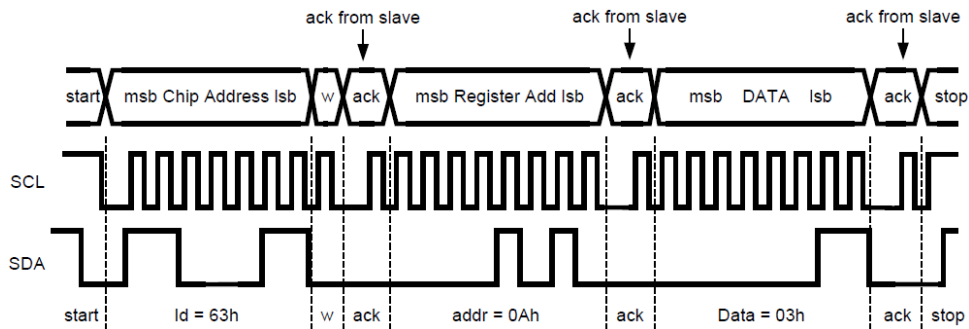

Figure 9. Write Cycle W = Write (SDA = "0") R = Read (SDA = "1") Ack = Acknowledge (SDA Pulled Down by Either Master or Slave) ID = Chip Address, 63h for AL3644

Application Information (continued)

4.2.4 I²C-Compatible Chip Address

The device address for the AL3644 is 1100011 (0x63). After the START condition, the I²C-compatible master sends the 7bit address followed by an eighth read or write bit (R/W). R/W = 0 indicates a WRITE and R/W = 1 indicates a READ. The second byte following the device address selects the register address to which the data is written. The third byte contains the data for the selected register.

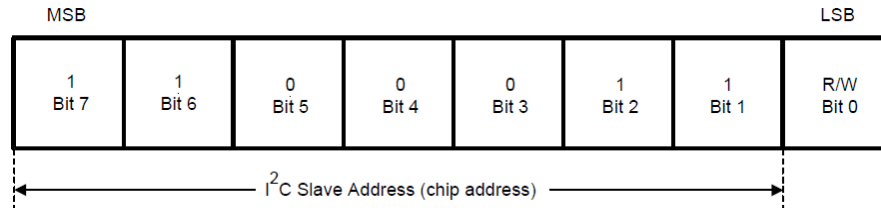

Figure 10. I²C-Compatible Chip Address

5. Register Descriptions

Register Name	Internal Hex Address	Power On/Reset Value AL3644
Enable Register	0x01	0x80
IVFM Register	0x02	0x01
LED1 Flash Brightness Register	0x03	0xBF
LED2 Flash Brightness Register	0x04	0x3F
LED1 Torch Brightness Register	0x05	0xBF
LED2 Torch Brightness Register	0x06	0x3F
Boost Configuration Register	0x07	0x09
Timing Configuration Register	0x08	0x1A
TEMP Register	0x09	0x08
Flags1 Register	0x0A	0x00
Flags2 Register	0x0B	0x00
Device ID Register	0x0C	0x02 or 0x04 for AL3644TT
Last Flash Register	0x0D	0x00

5.1 Enable Register (0x01) (Note 6)

Bit 7	Bit 6	Bit 5	Bit 4	Bit 3	Bit 2	Bit 1	Bit 0
TX Pin Enable 0 = Disabled 1 = Enabled (Default)	Strobe Type 0 = Level Triggered (Default) 1 = Edge Triggered	Strobe Enable 0 = Disabled (Default) 1 = Enabled	TORCH/TEMP Pin Enable 0 = Disabled (Default) 1 = Enabled	Mode Bits: M1, M0 00 = Standby (Default) 01 = IR Drive 10 = Torch 11 = Flash	LED2 Enable 0 = OFF (Default) 1 = ON	LED1 Enable 0 = OFF (Default) 1 = ON	

Note: 6. Edge Strobe Mode is not valid in IR Mode. Switching between Level and Edge Strobe Types while the device is enabled is not recommended. In Edge or Level Strobe Mode, it is recommended that the trigger pulse width be set greater than 1ms to ensure proper turn-on of the device.

Application Information (continued)

5.2 IVFM Register (0x02) (Note 7)

Bit 7	Bit 6	Bit 5	Bit 4	Bit 3	Bit 2	Bit 1	Bit 0
RFU	UVLO Circuitry (Default) 0 = Disabled (Default) 1 = Enabled	IVFM Levels 000 = 2.9V (Default) 001 = 3V 010 = 3.1V 011 = 3.2V 100 = 3.3V 101 = 3.4V 110 = 3.5V 111 = 3.6V			IVFM Hysteresis (Default) 0 = 0mV 1 = 50mV	IVFM Selection (Default) 00 = Disabled 01 = Stop and Hold Mode 10 = Down Mode 11 = Up and Down Mode	

Note: 7. IVFM Mode Bits are static once the AL3644 is enabled in Torch, Flash or IR modes. If the IVFM mode needs to be updated, disable the device and then change the mode bits to the desired state.

5.3 LED1 Flash Brightness Register (0x03)

Bit 7	Bit 6	Bit 5	Bit 4	Bit 3	Bit 2	Bit 1	Bit 0
LED2 Flash Current Override 0 = LED2 Flash Current is not set to LED1 Flash Current 1 = LED2 Flash Current is set to LED1 Flash Current (Default)	LED1 Flash Brightness Levels $I_{FLASH1/2} (mA) \approx (Brightness\ Code \times 11.725mA) + 10.9mA$ 0000000 = 10.9mA 0111111 = 750mA (Default) 1111111 = 1.5A						

5.4 LED2 Flash Brightness Register (0x04)

Bit 7	Bit 6	Bit 5	Bit 4	Bit 3	Bit 2	Bit 1	Bit 0
RFU	LED2 Flash Brightness Levels $I_{FLASH1/2} (mA) \approx (Brightness\ Code \times 11.725mA) + 10.9mA$ 0000000 = 10.9mA 0111111 = 750mA (Default) 1111111 = 1.5A						

Application Information (continued)

5.5 LED1 Torch Brightness Register (0x05)

Bit 7	Bit 6	Bit 5	Bit 4	Bit 3	Bit 2	Bit 1	Bit 0
LED2 Torch Current Override 0 = LED2 Torch Current is not set to LED1 Torch Current (Default) 1 = LED2 Torch Current is set to LED1 Torch Current (Default)	LED1 Torch Brightness Levels $I_{TORCH1/2} \text{ (mA)} \approx (\text{Brightness Code} \times 1.4\text{mA}) + 0.977\text{mA}$ or $I_{TORCH1/2} \text{ (mA)} \approx (\text{Brightness Code} \times 2.8\text{mA}) + 1.954\text{mA}$ (AL3644TT) 0000000 = 0.977mA or 1.954mA for AL3644TT 0111111 = 89.3mA (Default) or 178.6mA for AL3644TT 1111111 = 179mA or 360mA for AL3644TT						

5.6 LED2 Torch Brightness Register (0x06)

Bit 7	Bit 6	Bit 5	Bit 4	Bit 3	Bit 2	Bit 1	Bit 0
RFU	LED2 Torch Brightness Levels $I_{TORCH1/2} \text{ (mA)} \approx (\text{Brightness Code} \times 1.4\text{mA}) + 0.977\text{mA}$ or $I_{TORCH1/2} \text{ (mA)} \approx (\text{Brightness Code} \times 2.8\text{mA}) + 1.954\text{mA}$ (AL3644TT) 0000000 = 0.977mA or 1.954mA for AL3644TT 0111111 = 89.3mA (Default) or 178.6mA for AL3644TT 1111111 = 179mA or 360mA for AL3644TT						

5.7 Boost Configuration Register (0x07)

Bit 7	Bit 6	Bit 5	Bit 4	Bit 3	Bit 2	Bit 1	Bit 0
Software Reset Bit 0 = Not Reset (Default) 1 = Reset	RFU	RFU	RFU	LED Pin Short Fault Detect 0 = Disabled 1 = Enabled (Default)	Boost Mode 0 = Normal (Default) 1 = Pass Mode Only	Boost Frequency Select 0 = 2MHz (Default) 1 = 4MHz	Boost Current Limit Setting 0 = 1.9A 1 = 2.8A (Default)

Application Information (continued)

5.8 Timing Configuration Register (0x08) (Note 8)

Bit 7	Bit 6	Bit 5	Bit 4	Bit 3	Bit 2	Bit 1	Bit 0
RFU	Torch Current Ramp Time 000 = No Ramp 001 = 1ms (Default) 010 = 32ms 011 = 64ms 100 = 128ms 101 = 256ms 110 = 512ms 111 = 1024ms			Flash Timeout Duration 0000 = 10ms or 40ms (AL3644TT) 0001 = 20ms or 80ms (AL3644TT) 0010 = 30ms or 120ms (AL3644TT) 0011 = 40ms or 160ms (AL3644TT) 0100 = 50ms or 200ms (AL3644TT) 0101 = 60ms or 240ms (AL3644TT) 0110 = 70ms or 280ms (AL3644TT) 0111 = 80ms or 320ms (AL3644TT) 1000 = 90ms or 360ms (AL3644TT) 1001 = 100ms or 400ms (AL3644TT) 1010 = 150ms (Default) or 600ms (AL3644TT) 1011 = 200ms or 800ms (AL3644TT) 1100 = 250ms or 1000ms (AL3644TT) 1101 = 300ms or 1200ms (AL3644TT) 1110 = 350ms or 1400ms (AL3644TT) 1111 = 400ms or 1600ms (AL3644TT)			

Note: 8. On the AL3644TT, special care must be taken with regards to thermal management when using timeout values greater than 400ms. Depending on the PCB layout, input voltage and output current, it is possible to have the internal thermal shutdown circuit trip prior to reaching the desired flash timeout value.

5.9 TEMP Register (0x09) (Note 9)

Bit 7	Bit 6	Bit 5	Bit 4	Bit 3	Bit 2	Bit 1	Bit 0
RFU	TORCH Polarity 0 = Active High (Default) (Pulldown Resistor Enabled) 1 = Active Low (Pulldown Resistor Disabled)	NTC Open Fault Enable 0 = Disabled (Default) 1 = Enabled	NTC Short Fault Enable 0 = Disabled (Default) 1 = Enabled	TEMP Detect Voltage Threshold 000 = 0.2V 001 = 0.3V 010 = 0.4V 011 = 0.5V 100 = 0.6V (Default) 101 = 0.7V 110 = 0.8V 111 = 0.9V		TORCH/TEMP Function Select 0 = TORCH (Default) 1 = TEMP	

Note: 9. The Torch Polarity bit is static once the AL3644 is enabled in Torch, Flash or IR modes. If the Torch Polarity bit needs to be updated, disable the device and then change the Torch Polarity bit to the desired state.

5.10 Flags1 Register (0x0A)

Bit 7	Bit 6	Bit 5	Bit 4	Bit 3	Bit 2	Bit 1	Bit 0
TX Flag	VOUT Short Fault	VLED1 Short Fault	VLED2 Short Fault	Current Limit Flag	Thermal Shutdown (TSD) Fault	UVLO Fault	Flash Timeout Flag

Application Information (continued)

5.11 Flags2 Register (0x0B)

Bit 7	Bit 6	Bit 5	Bit 4	Bit 3	Bit 2	Bit 1	Bit 0
RFU	RFU	RFU	NTC Short Fault	NTC Open Fault	IVFM Trip Flag	OVP Fault	TEMP Trip Fault

5.12 Device ID Register (0x0C)

Bit 7	Bit 6	Bit 5	Bit 4	Bit 3	Bit 2	Bit 1	Bit 0
RFU	RFU	Device ID '000'			Silicon Revision Bit '010' or '100' for AL3644TT		

5.13 Last Flash Register (0x0D)

Bit 7	Bit 6	Bit 5	Bit 4	Bit 3	Bit 2	Bit 1	Bit 0
RFU	The value stored is always the last current value the IVFM detection block set. $I_{LED} = I_{FLASH - TARGET} \times ((Code + 1) / 128)$.						

Design Tools Resource

- [Evaluation Board User Guides](#)
- [Spice Models \(PSPICE Digital Simulation\)](#)
- [Evaluation Board GUI](#)

Ordering Information

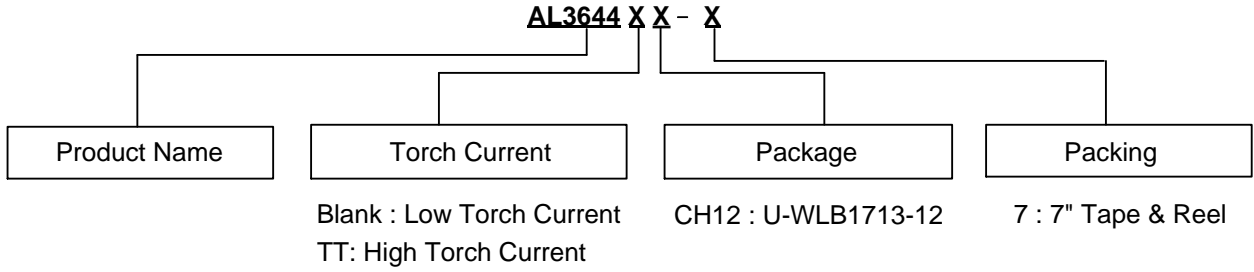

Part Number	Part Number Suffix	Package	Packing	
			Qty.	Carrier
AL3644CH12-7	-7	U-WLB1713-12 (Note 10)	3,000	Tape & Reel
AL3644TTCH12-7	-7	U-WLB1713-12 (Note 10)	3,000	Tape & Reel

Note: 10. For packaging details, go to our website at <https://www.diodes.com/design/support/packaging/diodes-packaging/>.

Marking Information

U-WLB1713-12

(Top View)

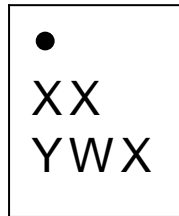

XX : Identification Code
 Y : Year : 0 to 9 (ex: 3 = 2023)
 W : Week : A to Z : week 1 to 26;
 a to z : week 27 to 52; z represents
 week 52 and 53
 X : Internal Code

Part Number	Package	Identification Code
AL3644CH12-7	U-WLB1713-12	2A
AL3644TTCH12-7	U-WLB1713-12	2B

Package Outline Dimensions

Please see <http://www.diodes.com/package-outlines.html> for the latest version.

U-WLB1713-12

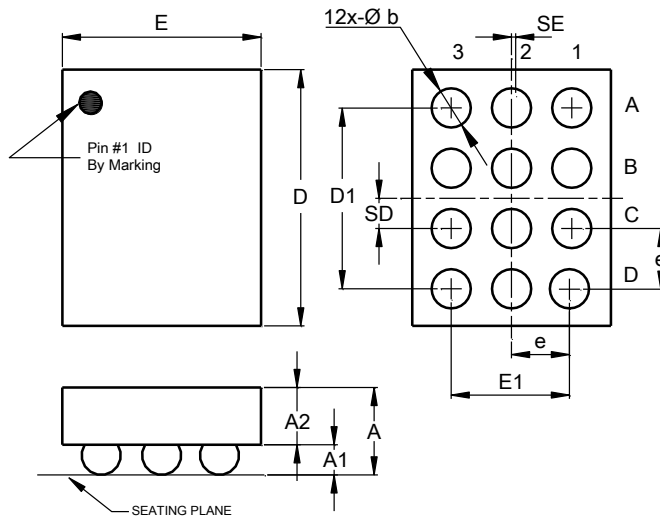

U-WLB1713-12			
Dim	Min	Max	Typ
A	0.525	0.625	0.575
A1	0.185	0.235	0.210
A2	0.340	0.390	0.365
b	0.220	0.300	0.260
D	1.690	1.750	1.720
D1	1.150	1.250	1.200
E	1.290	1.350	1.320
E1	0.750	0.850	0.800
e	0.400 BSC		
SD	0.200 BSC		
SE	0.000 BSC		
All Dimensions in mm			

Suggested Pad Layout

Please see <http://www.diodes.com/package-outlines.html> for the latest version.

U-WLB1713-12

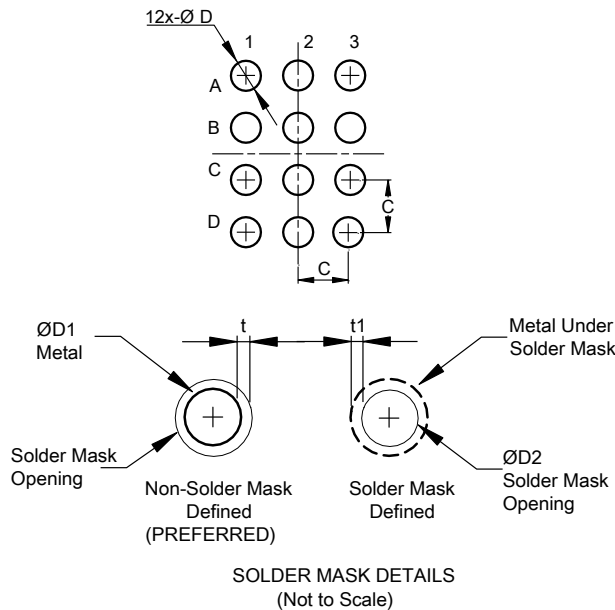

Dimensions	Value (in mm)
C	0.40
D	0.20
D1	0.20
D2	0.20
t	0.05 Max
t1	0.05 Min

Mechanical Data

Package: U-WLB1713-12

- Moisture Sensitivity: Level 1 per J-STD-020
- Terminals: SnAgCu Balls, Solderable per IPC/JEDEC J-STD-609 **e1**
- Weight: 0.00265 grams (Approximate)

IMPORTANT NOTICE

1. DIODES INCORPORATED (Diodes) AND ITS SUBSIDIARIES MAKE NO WARRANTY OF ANY KIND, EXPRESS OR IMPLIED, WITH REGARDS TO ANY INFORMATION CONTAINED IN THIS DOCUMENT, INCLUDING, BUT NOT LIMITED TO, THE IMPLIED WARRANTIES OF MERCHANTABILITY, FITNESS FOR A PARTICULAR PURPOSE OR NON-INFRINGEMENT OF THIRD PARTY INTELLECTUAL PROPERTY RIGHTS (AND THEIR EQUIVALENTS UNDER THE LAWS OF ANY JURISDICTION).
2. The Information contained herein is for informational purpose only and is provided only to illustrate the operation of Diodes' products described herein and application examples. Diodes does not assume any liability arising out of the application or use of this document or any product described herein. This document is intended for skilled and technically trained engineering customers and users who design with Diodes' products. Diodes' products may be used to facilitate safety-related applications; however, in all instances customers and users are responsible for (a) selecting the appropriate Diodes products for their applications, (b) evaluating the suitability of Diodes' products for their intended applications, (c) ensuring their applications, which incorporate Diodes' products, comply the applicable legal and regulatory requirements as well as safety and functional-safety related standards, and (d) ensuring they design with appropriate safeguards (including testing, validation, quality control techniques, redundancy, malfunction prevention, and appropriate treatment for aging degradation) to minimize the risks associated with their applications.
3. Diodes assumes no liability for any application-related information, support, assistance or feedback that may be provided by Diodes from time to time. Any customer or user of this document or products described herein will assume all risks and liabilities associated with such use, and will hold Diodes and all companies whose products are represented herein or on Diodes' websites, harmless against all damages and liabilities.
4. Products described herein may be covered by one or more United States, international or foreign patents and pending patent applications. Product names and markings noted herein may also be covered by one or more United States, international or foreign trademarks and trademark applications. Diodes does not convey any license under any of its intellectual property rights or the rights of any third parties (including third parties whose products and services may be described in this document or on Diodes' website) under this document.
5. Diodes' products are provided subject to Diodes' Standard Terms and Conditions of Sale (<https://www.diodes.com/about/company/terms-and-conditions/terms-and-conditions-of-sales/>) or other applicable terms. This document does not alter or expand the applicable warranties provided by Diodes. Diodes does not warrant or accept any liability whatsoever in respect of any products purchased through unauthorized sales channel.
6. Diodes' products and technology may not be used for or incorporated into any products or systems whose manufacture, use or sale is prohibited under any applicable laws and regulations. Should customers or users use Diodes' products in contravention of any applicable laws or regulations, or for any unintended or unauthorized application, customers and users will (a) be solely responsible for any damages, losses or penalties arising in connection therewith or as a result thereof, and (b) indemnify and hold Diodes and its representatives and agents harmless against any and all claims, damages, expenses, and attorney fees arising out of, directly or indirectly, any claim relating to any noncompliance with the applicable laws and regulations, as well as any unintended or unauthorized application.
7. While efforts have been made to ensure the information contained in this document is accurate, complete and current, it may contain technical inaccuracies, omissions and typographical errors. Diodes does not warrant that information contained in this document is error-free and Diodes is under no obligation to update or otherwise correct this information. Notwithstanding the foregoing, Diodes reserves the right to make modifications, enhancements, improvements, corrections or other changes without further notice to this document and any product described herein. This document is written in English but may be translated into multiple languages for reference. Only the English version of this document is the final and determinative format released by Diodes.
8. Any unauthorized copying, modification, distribution, transmission, display or other use of this document (or any portion hereof) is prohibited. Diodes assumes no responsibility for any losses incurred by the customers or users or any third parties arising from any such unauthorized use.
9. This Notice may be periodically updated with the most recent version available at <https://www.diodes.com/about/company/terms-and-conditions/important-notice>

The Diodes logo is a registered trademark of Diodes Incorporated in the United States and other countries.
All other trademarks are the property of their respective owners.
© 2023 Diodes Incorporated. All Rights Reserved.

www.diodes.com

Looking for pricing, stock, or lifecycle information?

Click below to explore more details on WIN SOURCE:

 [View AL3644CH12-7 on WIN SOURCE](#)

 [Diodes Incorporated](#) Information

Optimize Your Supply Chain with WIN SOURCE Solutions

-  Global Sourcing Solution
-  Obsolete Management
-  Cost Control Management
-  Shortage Management
-  Alternative Solution
-  Excess Inventory Management