

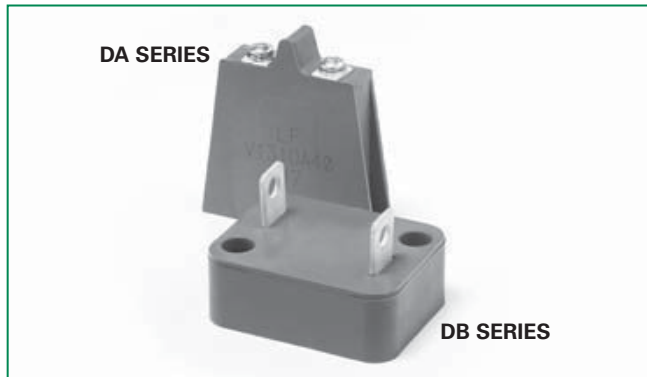

**THE DATASHEET OF  
V321DA40**



**RoHS (Pb) DA/DB Varistor Series**

**Description**

The DA and DB Series transient surge suppressors are heavy-duty industrial Metal-Oxide Varistors (MOVs) designed to provide surge protection for motor controls and power supplies used in oil-drilling, mining, and transportation equipment.

These UL recognized varistors have identical ratings and specifications but differ in case construction to provide flexibility in equipment designs.

DA Series devices feature rigid terminals to ensure secure wire contacts. Both the DA and DB Series feature improved creep and strike distance capability to minimize breakdown along the package surface design that provides complete electrical isolation of the disc subassembly.

See DA/DB Series Device Ratings and Specifications table for part number and brand information.

**Agency Approvals**

Agency	Agency File Number
	E320116

**Features**

- RoHS compliant and Lead-free
- High energy absorption capability  $W_{TM}$  up to 1050J
- Wide operating voltage range  $V_{M(AC)RMS}$  130V to 750V
- Screw terminals (DA Series), quick connect push-on connectors (DB Series)
- Case design provides complete electrical isolation of disc subassembly
- 40mm diameter disc
- No derating up to 85°C ambient

**Absolute Maximum Ratings**

• For ratings of individual members of a series, see Device Ratings and Specifications chart

Continuous	DA/DB Series	Units
Steady State Applied Voltage:		
AC Voltage Range ( $V_{M(AC)RMS}$ )	130 to 750	V
DC Voltage Range ( $V_{M(DC)}$ )	175 to 970	V
Transients:		
Peak Pulse Current ( $I_{TM}$ )		
For 8/20 $\mu$ s Current Wave (See Figure 2)	40,000	A
Single Pulse Energy Range		
For 2ms Current Squarewave ( $W_{TM}$ )	270 to 1050	J
Operating Ambient Temperature Range ( $T_A$ )	-55 to +85	°C
Storage Temperature Range ( $T_{STG}$ )	-55 to +125	°C
Temperature Coefficient ( $\alpha^V$ ) of Clamping Voltage ( $V_C$ ) at Specified Test Current	<0.01	%/°C
Hi-Pot Encapsulation (COATING Isolation Voltage Capability) (Dielectric must withstand indicated DC voltage for one minute per MIL-STD 202, Method 301)	5000	V
COATING Insulation Resistance	1000	M $\Omega$

**CAUTION:** Stresses above those listed in "Absolute Maximum Ratings" may cause permanent damage to the device. This is a stress only rating and operation of the device at these or any other conditions above those indicated in the operational sections of this specification is not implied.

### DA/DB Series Ratings & Specifications

Part Number Device Branding		Maximum Rating (85°C)				Specifications (25°C)				
		Continuous		Transient		Varistor Voltage at 1mA DC Test Current			Maximum Clamping Volt $V_C$ at 200A Current (8/20 $\mu$ s)	Typical Capaci- tance $f =$ 1MHz
		$V_{RMS}$	$V_{DC}$	Energy (2ms)	Peak Current 8 x 20 $\mu$ s					
DA	DB	$V_{M(AC)}$ (V)	$V_{M(DC)}$ (V)	$W_{TM}$ (J)	$I_{TM}$ (A)	(V)	(V)	(V)	$V_C$ (A)	C (pF)
V131DA40	V131DB40	130	175	270	40000 <sup>1</sup>	184	200	228	345	10000
V151DA40	V151DB40	150	200	300	40000 <sup>2</sup>	212	240	268	405	8000
V251DA40	V251DB40	250	330	370	40000	354	390	429	650	5000
V271DA40	V271DB40	275	369	400	40000	389	430	473	730	4500
V321DA40	V321DB40	320	420	460	40000	462	510	561	830	3800
V421DA40	V421DB40	420	560	600	40000	610	680	748	1130	3000
V481DA40	V481DB40	480	640	650	40000	670	750	825	1240	2700
V511DA40	V511DB40	510	675	700	40000	735	820	910	1350	2500
V571DA40	V571DB40	575	730	770	40000	805	910	1000	1480	2200
V661DA40	V661DB40	660	850	900	40000	940	1050	1160	1720	2000
V751DA40	V751DB40	750	970	1050	40000	1080	1200	1320	2000	1800

Note : Average power dissipation of transients not to exceed 2.0W.

### Power Dissipation Ratings

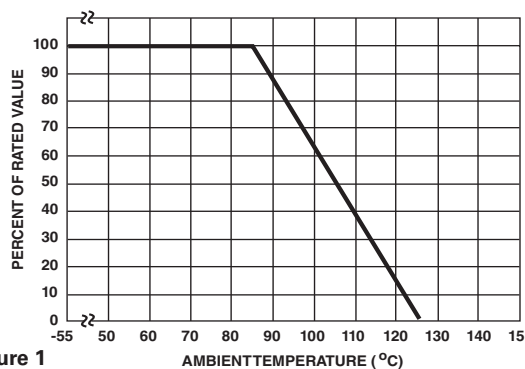

Figure 1

**NOTES:**

1. Peak current Applies to applications rated up to 115VRMS. Peak current is 30kA for applications greater than 115V.
2. Peak current applies to applications rated up to 132VRMS. Peak Current is 30kA for applications greater than 132V.

Should transients occur in rapid succession, the average power dissipation required is simply the energy (watt- seconds) per pulse times the number of pulses per second. The power so developed must be within the specifications shown on the Device Ratings and Specifications table for the specific device. Furthermore, the operating values need to be derated at high temperatures as shown above. Because varistors can only dissipate a relatively small amount of average power they are, therefore, not suitable for repetitive applications that involve substantial amounts of average power dissipation.

### Peak Pulse Current Test Waveform

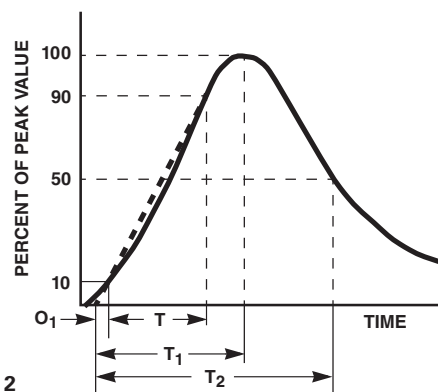

Figure 2

- $O_1$  = Virtual Origin of Wave
- $T$  = Time from 10% to 90% of Peak
- $T_1$  = Rise Time = 1.25 x  $T$
- $T_2$  = Decay Time

**Example** - For an 8/20  $\mu$ s Current Waveform:

- $8\mu s = T_1 =$  Rise Time
- $20\mu s = T_2 =$  Decay Time

### Maximum Clamping Voltage

V131DA40 - V751DA40 and V131DB40 - V751DB40

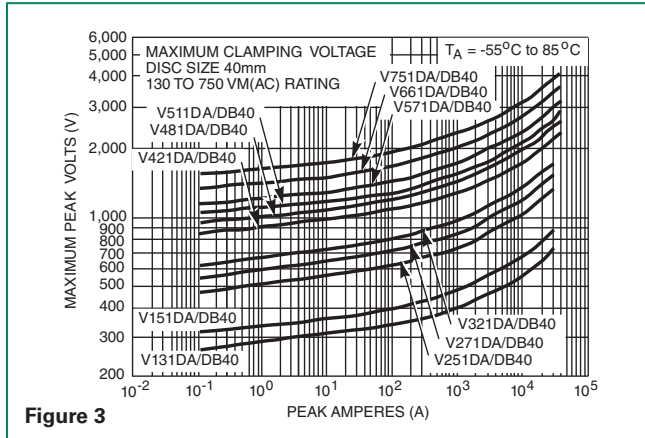

Figure 3

NOTE: If pulse ratings are exceeded, a shift of  $V_{NIDCI}$  (at specified current) of more than +/-10% could result. This type of shift, which normally results in a decrease of  $V_{NIDCI}$ , may result in the device not meeting the original published specifications, but it does not prevent the device from continuing to function, and to provide ample protection.

### Repetitive Surge Capability

V131DA40 - V751DA40 and V131DB40 - V751DB40

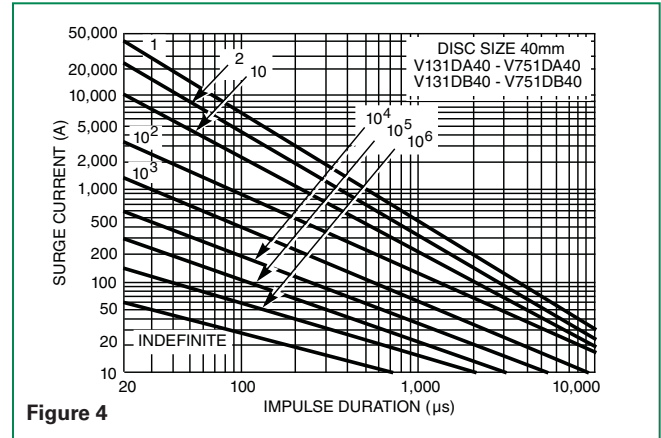

Figure 4

### Physical Specifications

<b>Lead Material</b>	DA - Copper, Tin-plated DB - Brass, Tin-plated
<b>Insulating Material</b>	Cured, flame retardant epoxy polymer meets UL94V-0 requirements.
<b>Device Labeling</b>	Marked with LF, part number and date code

### Environmental Specifications

<b>Operating/Storage Temperature</b>	-55°C to +85°C / -55°C to +125°C
<b>Humidity Aging</b>	+85°C, 85% RH, 1000 hours +/- 5% typical resistance change
<b>Thermal Shock</b>	+85°C to -40°C 10 times +/- 5% typical resistance change
<b>Solvent Resistance</b>	MIL-STD-202, Method 215F
<b>Moisture Sensitivity</b>	Level 1, J-STD-020C

### Product Dimensions (mm)

#### DA SERIES

#### DB SERIES

"A" DIMENSION:  
 FILISTER HEAD SCREW - 51mm (2.01)  
 PAN HEAD SCREW - 53mm (2.09)

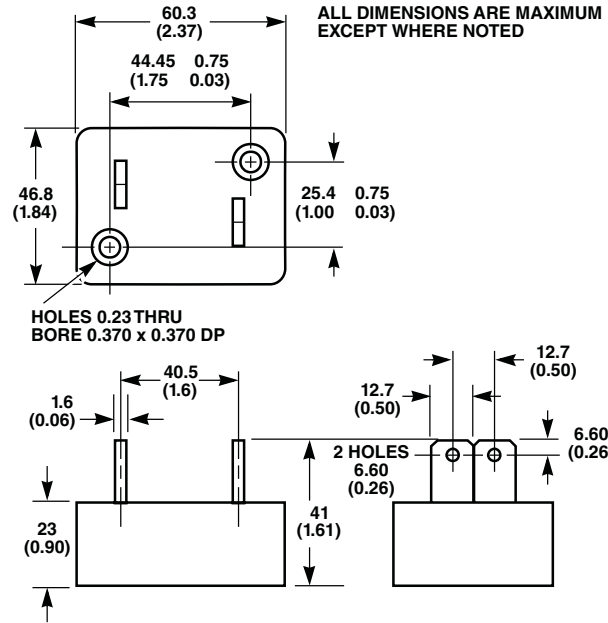
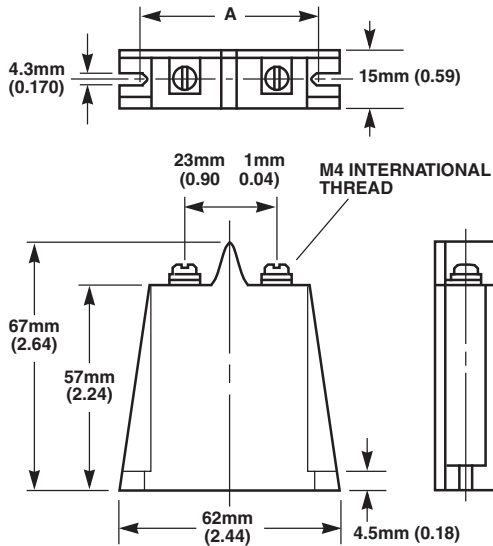

Dimensions in millimeters and (inches).

### Part Numbering System

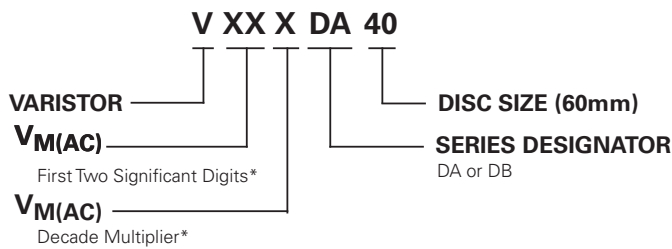

\*Refer to Rating & Specifications table  
 Example:  
 130 VM(AC) = 131

## Looking for pricing, stock, or lifecycle information?

Click below to explore more details on WIN SOURCE:

 [View V321DA40 on WIN SOURCE](#)

 [Littelfuse Inc. Information](#)

## Optimize Your Supply Chain with WIN SOURCE Solutions

-  Global Sourcing Solution
-  Obsolete Management
-  Cost Control Management
-  Shortage Management
-  Alternative Solution
-  Excess Inventory Management