



**THE DATASHEET OF  
MFS101D-8-Z**



# MFS

## Sub-miniature Switches



RoHS Compliant

### Common Specifications

#### Initial contact resistance

Measured at 1.5 mA 200  $\mu$ VAC 1kHz

#### Dielectric strength

Measurement at 500 VAC.

#### Insulation Resistance

Measured at 500 VDC

#### Operating temperature range

-10°C ~ +70°C

### Part Numbering

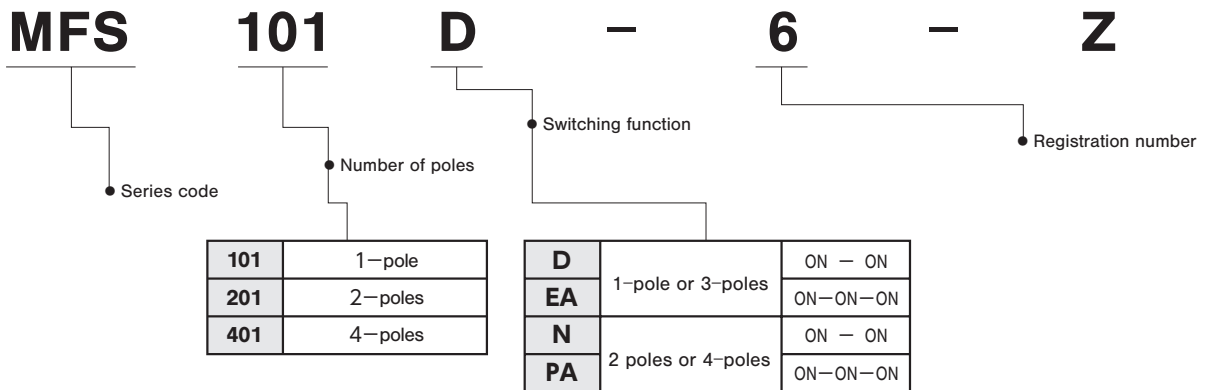

### MFS101D-6-Z

Non-shorting

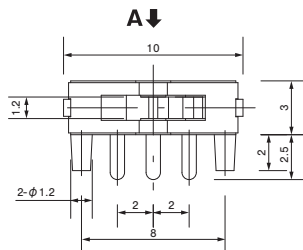
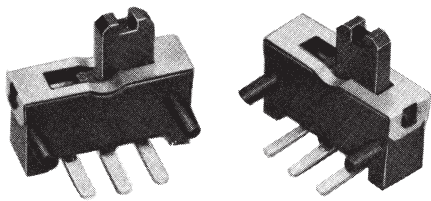

### PC Hole Layouts

(Top view)

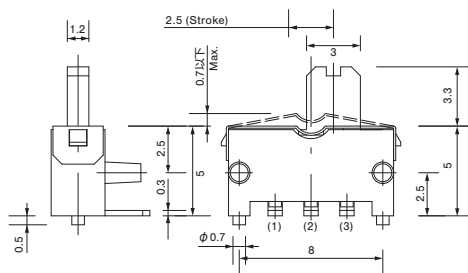
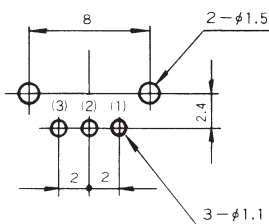

### Specifications

Rating	Max.	DC10V 0.3A (Resistive load)
	Min.	DC5V 10mA (Resistive load)
Initial contact resistance	20m $\Omega$ Max.	
Dielectric strength	AC500V 1 minute	
Insulation resistance	100M $\Omega$ Min.	
Electrical life	5,000 cycles	
Operating force	0.98~2.94N	
Switch timing	Non-shorting	

Switching function (/Viewed from A)	Circuit diagram	No. of terminals
		3
ON		
2-3		
2-1		

Terminal numbers are not shown on the switch.

**MFS101D-8-Z**

shorting

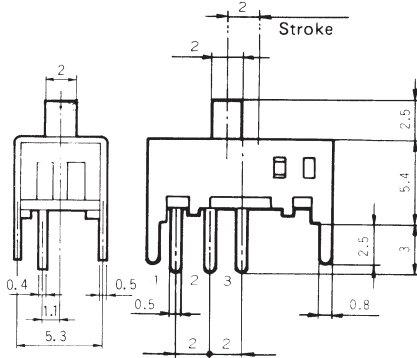
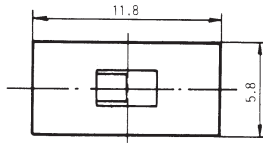
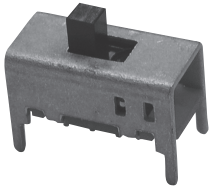

Terminal numbers are not shown on the switch.

**PC Hole Layouts**

(Top view)

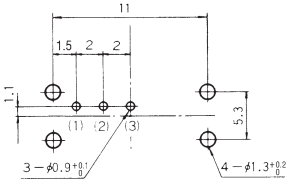

**Specifications**

Rating	Max.	DC30V 0.3A AC30V 2A (Resistive load)
	Min.	DC5V 10mA (Resistive load)
Initial contact resistance	20mΩ Max.	
Dielectric strength	AC500V 1 minute	
Insulation resistance	100MΩ Min.	
Electrical life	5,000 cycles at DC30V 0.3A 100cycles at AC30V 2A	
Operating force	2.45±0.98 N	
Switch timing	Shorting	

Switching function (Viewed from A)	Circuit diagram	No. of terminals
		 3
2-1	2-3	

**MFS101D-9-Z**

Non-shorting

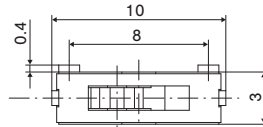
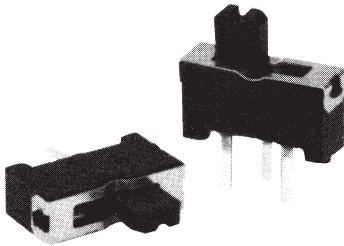

A ↑

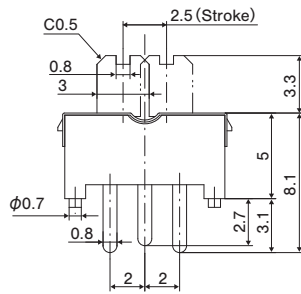
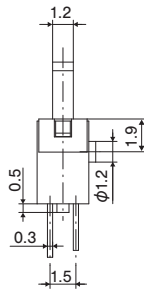

Terminal numbers are not shown on the switch.

**PC Hole Layouts**

(Top view)

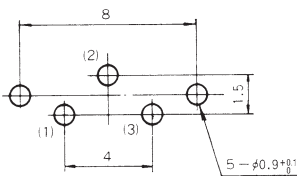

**Specifications**

Rating	Max.	DC12V 0.3A (Resistive load)
	Min.	DC5V 10mA (Resistive load)
Initial contact resistance	20mΩ Max.	
Dielectric strength	AC500V 1 minute	
Insulation resistance	100MΩ Min.	
Electrical life	5,000 cycles	
Operating force	0.98±2.94N	
Switch timing	Non-shorting	

Switching function (Viewed from A)	Circuit diagram	No. of terminals
		 3
2-1	2-3	

☆ **MFS101D-10-Z**

Non-shorting

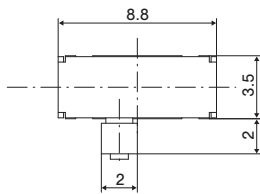
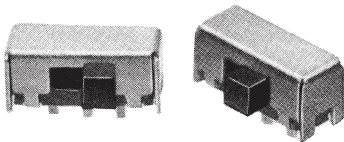

A ↓

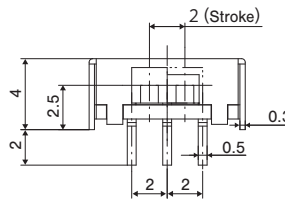
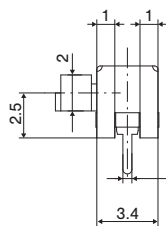

Terminal numbers are not shown on the switch.

**PC Hole Layouts**

(Top view)

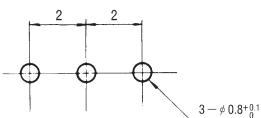

**Specifications**

Rating	Max.	DC30V 0.3A (Resistive load)
	Min.	DC5V 10mA (Resistive load)
Initial contact resistance	20mΩ Max.	
Dielectric strength	AC500V 1 minute	
Insulation resistance	100MΩ Min.	
Electrical life	5,000 cycles	
Operating force	2.94±1.96N	
Switch timing	Non-shorting	

Switching function (Viewed from A)	Circuit diagram	No. of terminals
		 3
2-3	2-1	

**MFS101D-14-Z**

Non-shorting

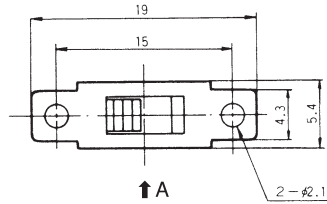
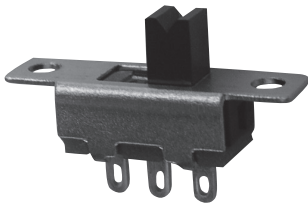

**Panel Cut-Out Dimensions**

(Top view)

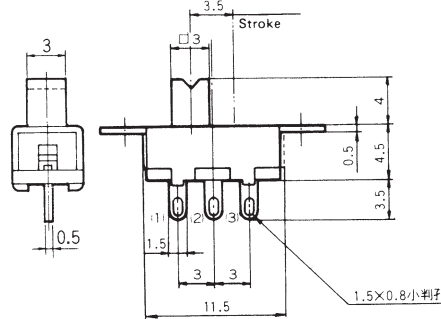
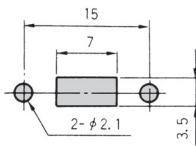

Terminal numbers are not shown on the switch.

**Specifications**

Rating	Max.	DC30V 0.3A (Resistive load)
	Min.	DC5V 10mA (Resistive load)
Initial contact resistance	20mΩ Max.	
Dielectric strength	AC500V 1 minute	
Insulation resistance	100MΩ Min.	
Electrical life	5,000 cycles	
Operating force	1.96±0.98N	
Switch timing	Non-shorting	

Switching function (Viewed from A)		Circuit diagram	No. of terminals
			3
ON	ON		
2-1	2-3		

☆ **MFS101EA-Z**

[Note] See below.

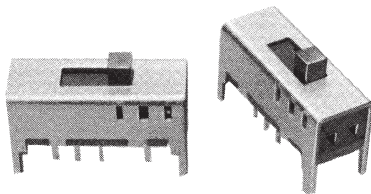

**Specifications**

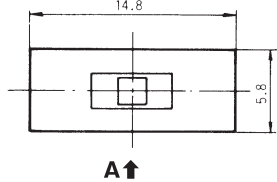

Rating	Max.	DC30V 0.3A AC30V 2A (Resistive load)
	Min.	DC5V 10mA (Resistive load)
Initial contact resistance	20mΩ Max.	
Dielectric strength	AC500V 1 minute	
Insulation resistance	100MΩ Min.	
Electrical life	5,000 cycles at DC30V 0.3A 100cycles at AC30V 2A	
Operating force	2.45±0.98N 1.47±0.98N	
Switch timing	Undefined	

**PC Hole Layouts**

(Top view)

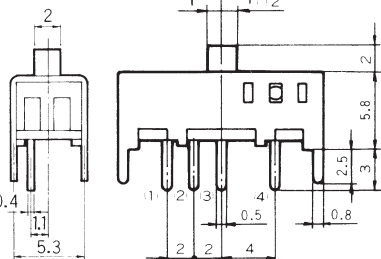
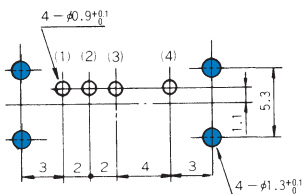

Terminal numbers are not shown on the switch.

Switching function (Viewed from A)			Circuit diagram	No. of terminals
				4
ON	ON	ON		
3-1	3-2	3-4		

↔ : Operating force from the center to the outer side (right or left).  
 ↔ : Operating force from the outer side (right or left) to the center.

**MFS201N-Z**

Non-shorting

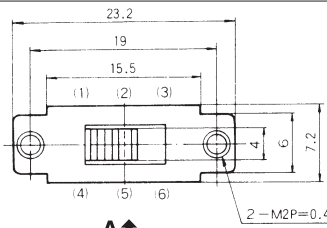
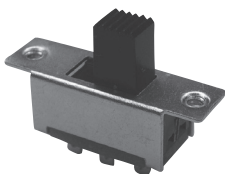

**Panel Cut-Out Dimensions**

(Top view)

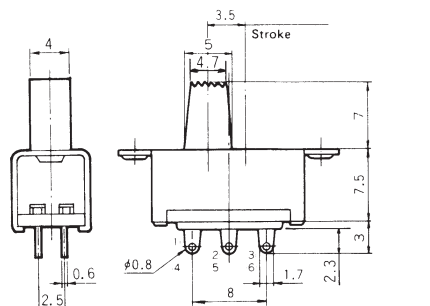
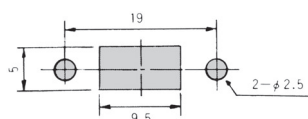

Terminal numbers are not shown on the switch.

**Specifications**

Rating	Max.	AC125V 1A · DC30V 1A
	Min.	DC5V 10mA (Resistive load)
Initial contact resistance	30mΩ Max.	
Dielectric strength	AC500V 1 minute	
Insulation resistance	300MΩ Min.	
Electrical life	5,000 cycles	
Operating force	0.98~4.9N	
Switch timing	Non-shorting	

Switching function (Viewed from A)		Circuit diagram	No. of terminals
			6
ON	ON		
2-1 5-4	2-3 5-6		

※ : Please note that MFS101EA-Z can be either Shorting or Non-shorting.

☆ : Semi-standard products.

**MFS201N-4-Z**

Non-shorting

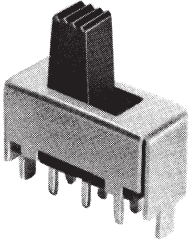

**PC Hole Layouts**  
(Top view)

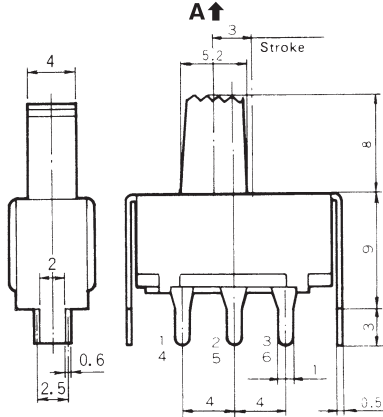
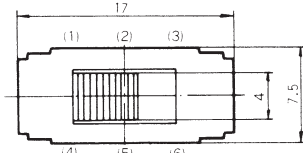
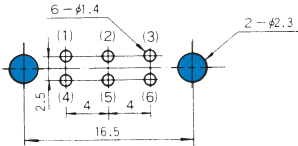

Terminal numbers are not shown on the switch.

**Specifications**

Rating	Max.	AC125V 1A · DC30V 1A
	Min.	DC5V 10mA (Resistive load)
Initial contact resistance	20mΩ Max.	
Dielectric strength	AC500V 1 minute	
Insulation resistance	300MΩ Min.	
Electrical life	5,000 cycles	
Operating force	1.47~4.41N	
Switch timing	Non-shorting	

Switching function (Viewed from A)	Circuit diagram	No. of terminals
ON ON		6
2-1 5-4		
2-3 5-6		

☆ : Semi-standard products.

**MFS201N-9-Z**

Non-shorting

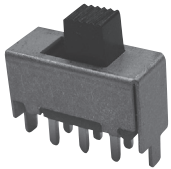

**PC Hole Layouts**  
(Top view)

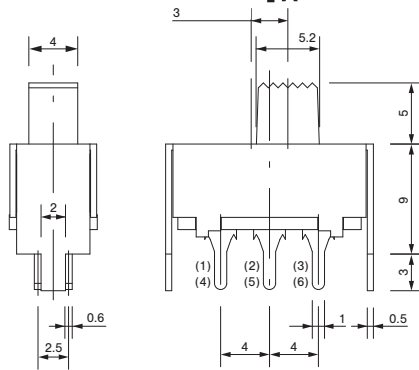
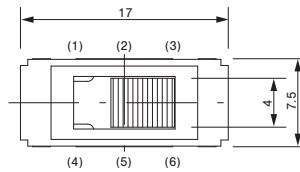
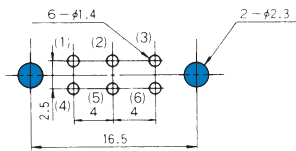

Terminal numbers are not shown on the switch.

**Specifications**

Rating	Max.	AC125V 1A · DC30V 1A
	Min.	DC5V 10mA (Resistive load)
Initial contact resistance	20mΩ Max.	
Dielectric strength	AC500V 1 minute	
Insulation resistance	300MΩ Min.	
Electrical life	5,000 cycles	
Operating force	1.47~4.41N	
Switch timing	Non-shorting	

Switching function (Viewed from A)	Circuit diagram	No. of terminals
ON ON		6
2-1 5-4		
2-3 5-6		

**MFS201N-16-Z**

Non-shorting

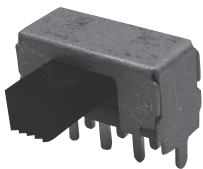

**PC Hole Layouts**  
(Top view)

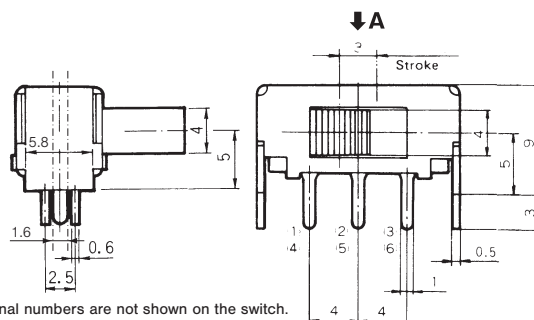
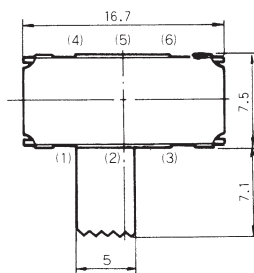
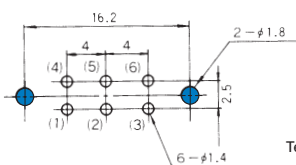

Terminal numbers are not shown on the switch.

**Specifications**

Rating	Max.	AC125V 1A · DC30V 1A
	Min.	DC5V 10mA (Resistive load)
Initial contact resistance	20mΩ Max.	
Dielectric strength	AC500V 1 minute	
Insulation resistance	100MΩ Min.	
Electrical life	5,000 cycles	
Operating force	2.94±1.47N	
Switch timing	Non-shorting	

Switching function (Viewed from A)	Circuit diagram	No. of terminals
ON ON		6
2-3 5-6		
2-1 5-4		

**MFS201N-19-Z**

Shorting

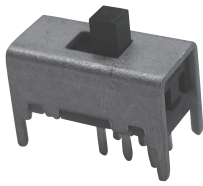

**PC Hole Layouts**

(Top view)

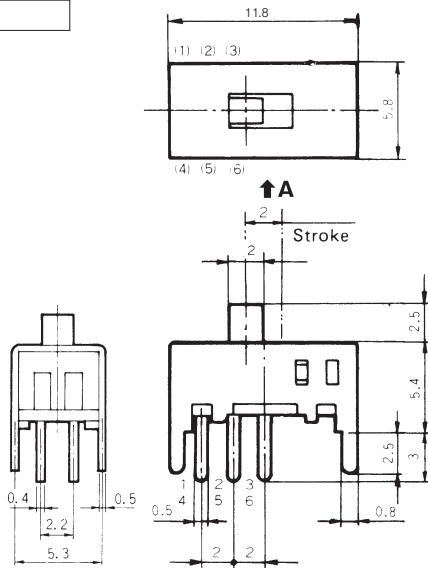
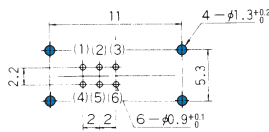

Terminal numbers are not shown on the switch.

**Specifications**

Rating	Max.	DC30V 0.3A (Resistive load)
	Min.	DC5V 10mA (Resistive load)
Initial contact resistance	20mΩ Max.	
Dielectric strength	AC500V 1 minute	
Insulation resistance	100MΩ Min.	
Electrical life	5,000 cycles	
Operating force	2.45 ± 0.98N	
Switch timing	Shorting	

Switching function (Viewed from A)		Circuit diagram	No. of terminals
			6
2-1	2-3		
5-4	5-6		

★ **MFS201N-20-Z**

Shorting

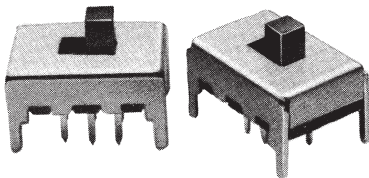

**PC Hole Layouts**

(Top view)

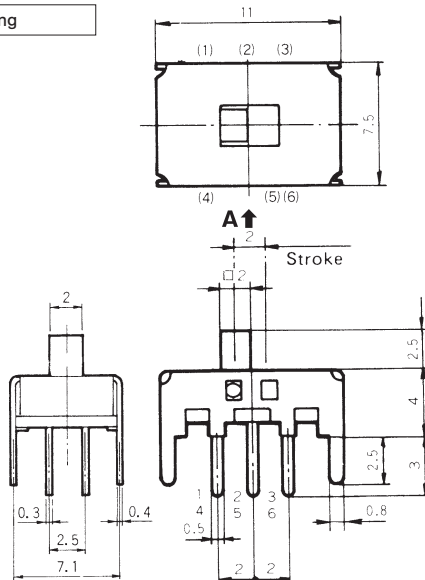
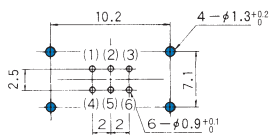

Terminal numbers are not shown on the switch.

**Specifications**

Rating	Max.	DC30V 0.3A (Resistive load)
	Min.	DC5V 10mA (Resistive load)
Initial contact resistance	20mΩ Max.	
Dielectric strength	AC500V 1 minute	
Insulation resistance	100MΩ Min.	
Electrical life	5,000 cycles	
Operating force	4.41 ± 1.47N	
Switch timing	Shorting	

Switching function (Viewed from A)		Circuit diagram	No. of terminals
			6
2-1	2-3		
5-4	5-6		

**MFS201N-21-Z**

Non-shorting

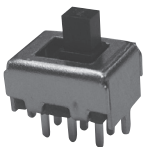

**PC Hole Layouts**

(Top view)

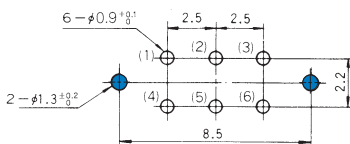

Terminal numbers are not shown on the switch.

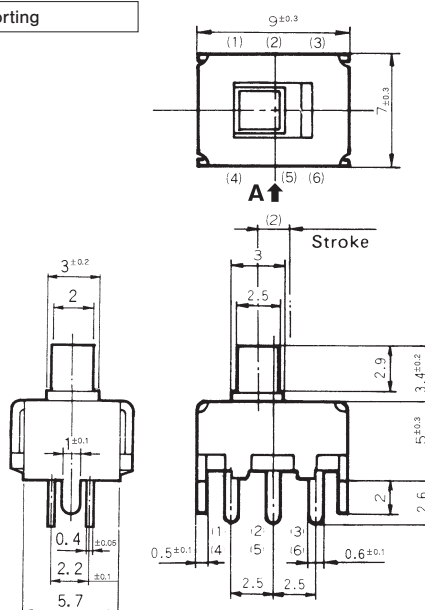

**Specifications**

Rating	Max.	DC30V 0.3A (Resistive load)
	Min.	DC5V 10mA (Resistive load)
Initial contact resistance	20mΩ Max.	
Dielectric strength	AC500V 1 minute	
Insulation resistance	100MΩ Min.	
Electrical life	5,000 cycles	
Operating force	2.45 ± 0.98N	
Switch timing	Non-shorting	

Switching function (A Viewed from A)		Circuit diagram	No. of terminals
			6
2-1	2-3		
5-4	5-6		

**MFS201N-23-Z**

Non-shorting

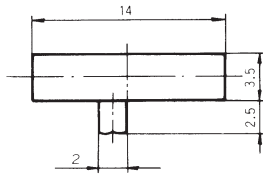
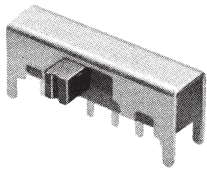

↓ A

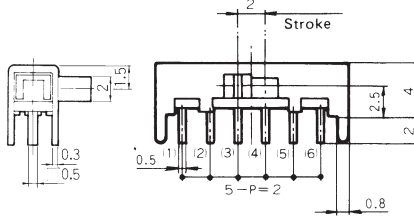

Terminal numbers are not shown on the switch.

**PC Hole Layouts**

(Top view)

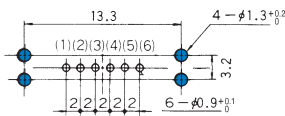

**Specifications**

Rating	Max.	DC30V 0.3A (Resistive load)
	Min.	DC5V 10mA (Resistive load)
Initial contact resistance	20mΩ Max.	
Dielectric strength	AC500V 1 minute	
Insulation resistance	100MΩ Min.	
Electrical life	5,000 cycles	
Operating force	3.92±2.45N	
Switch timing	Non-shorting	

Switching function (Viewed from A)		Circuit diagram	No. of terminals
2-3 5-6	2-1 5-4		

**MFS201N-24-Z**

Non-shorting

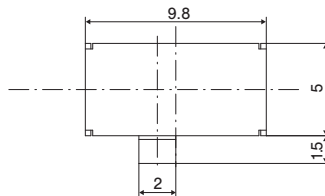
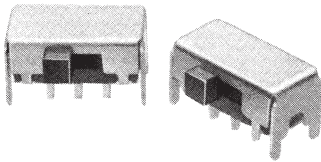

↓ A

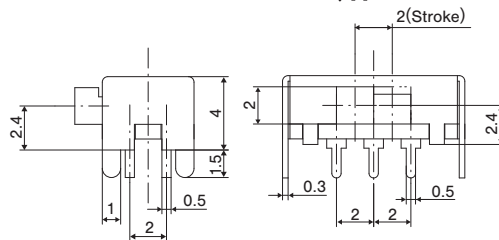

Terminal numbers are not shown on the switch.

**PC Hole Layouts**

(Top view)

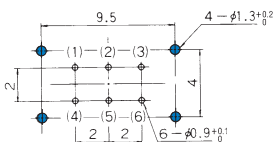

**Specifications**

Rating	Max.	DC30V 0.3A (Resistive load)
	Min.	DC5V 10mA (Resistive load)
Initial contact resistance	20mΩ Max.	
Dielectric strength	AC500V 1 minute	
Insulation resistance	100MΩ Min.	
Electrical life	5,000 cycles	
Operating force	1.96±0.98N	
Switch timing	Non-shorting	

Switching function (Viewed from A)		Circuit diagram	No. of terminals
2-3 5-6	2-1 5-4		

**★MFS201PA-4-Z**

[Note] See below.

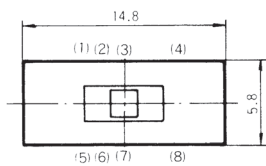
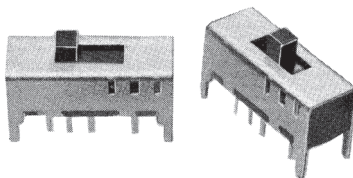

↑ A

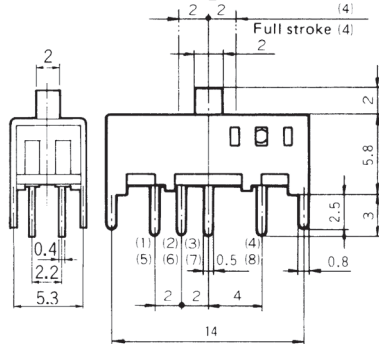

Terminal numbers are not shown on the switch.

**PC Hole Layouts**

(Top view)

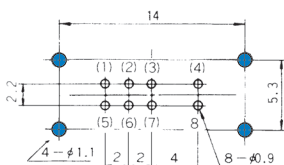

**Specifications**

Rating	Max.	DC30V 0.3A (Resistive load)
	Min.	DC5V 10mA (Resistive load)
Initial contact resistance	20mΩ Max.	
Dielectric strength	AC500V 1 minute	
Insulation resistance	100MΩ Min.	
Electrical life	5,000 cycles	
Operating force	 2.45±0.98N 1.47±0.98N	
Switch timing	Undefined	

Switching function (Viewed from A)			Circuit diagram	No. of terminals
3-1 7-5	3-2 7-6	3-4 7-8		

: Operating force from the center to the outer side (right or left).  
 : Operating force from the outer side (right or left) to the center.



**■Soldering**

(1)Manual Soldering

Device : Soldering iron

Please refer to “MFS Series Heat-resistant Table” shown below.

(2)Auto Soldering

**MFS** series are not compatible with auto soldering. Soldering should be done manually.

(3)When soldering two or more terminals to the common land, use solder resist to solder them independently.

**■Flux Cleaning**

(1)Solvent : Fluorine or Alcohol type.

(2)MFS Series are not process sealed. If the PC board is to be cleaned, clean the soldering surface of substrate with a brush so that the switch is not exposed to the cleaning solution.

**■Frequency of switch use**

If the switch is not likely to be operated frequently (e.g. two or three operations a year) in the dry circuit area, a sulfide film is likely to be formed on the contacts, resulting in contact failure. If this is the case, gold-plated products are recommended. Please contact your local Nidec Components sales representative.

**■MFS series heat-resistant table**

Resin board	MFS101D-6-Z	270°C MAX. 3sec MAX.
	MFS101D-9-Z	
Phenol board	MFS101D-8-Z	360°C MAX. 3sec MAX.
	MFS201N-19-Z	
	MFS201N-20-Z	
	MFS101D-10-Z	
	MFS101D-14-Z	
	MFS201N-Z	
	MFS201N-4-Z	
	MFS201N-9-Z	
	MFS201N-16-Z	
	MFS201N-21-Z	
	MFS201N-23-Z	
	MFS201N-24-Z	
	MFS201PA-4-Z	
	MFS101EA-Z	
	MFS201PA-5-Z	
MFS401N-2-Z		

**■Packaging Specifications**

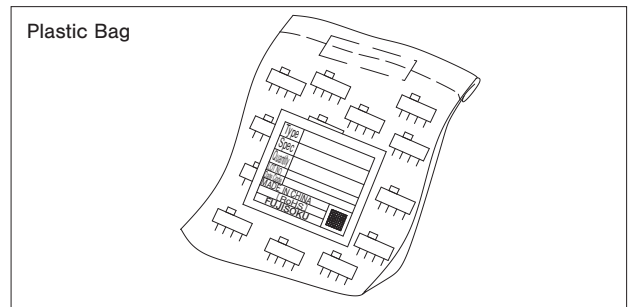

■ Shorting (Make-Before-Break)

A switch which momentarily connects both circuits when the actuator is moved from Point A to B in the below figure.

All switches which are not marked as "Shorting" are "Non-shorting" (Break-Before-Make).

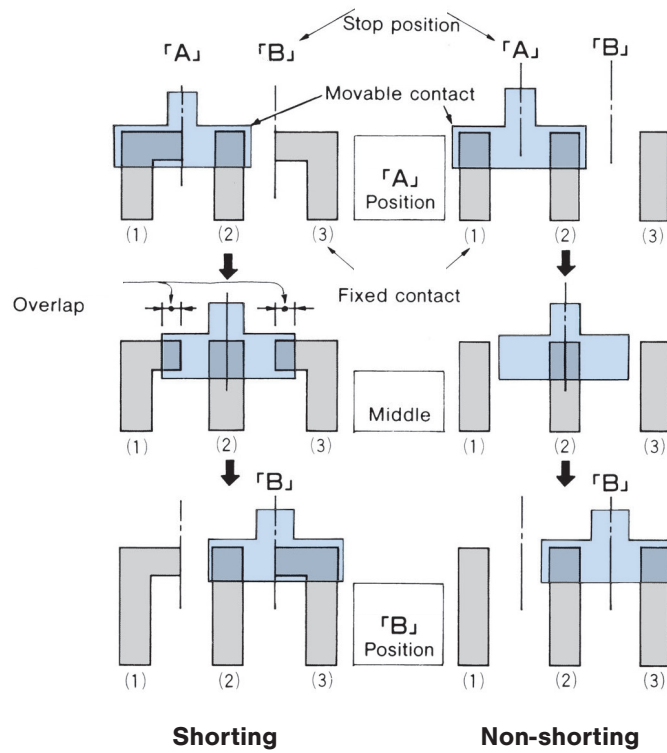

[Fig.1]

## Looking for pricing, stock, or lifecycle information?

Click below to explore more details on WIN SOURCE:

- ⊖ [View MFS101D-8-Z on WIN SOURCE](#)
- ⊖ [Nidec Copal Electronics Information](#)

## Optimize Your Supply Chain with WIN SOURCE Solutions

- ✓ Global Sourcing Solution
- ✓ Obsolete Management
- ✓ Cost Control Management
- ✓ Shortage Management
- ✓ Alternative Solution
- ✓ Excess Inventory Management