



**THE DATASHEET OF  
TP12SH9V3BE**



# TP Series

## Tiny Pushbutton Switches

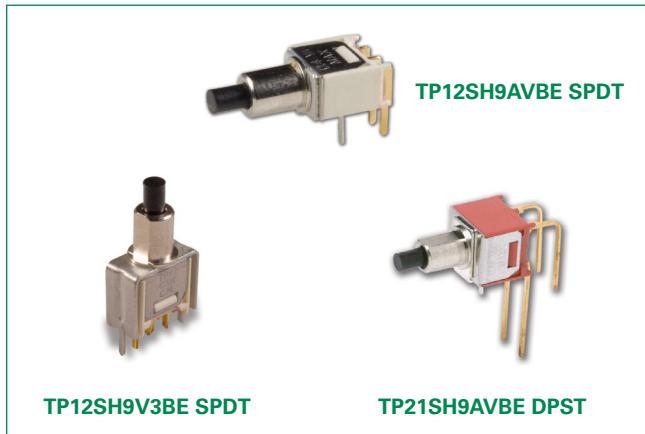

### Agency Approvals

Agency	Agency File Number
	E42363

### Specifications

<b>Contact Rating</b>	B contact material: 0.4 VA max. @ 20 V AC or DC max. Q contact material: 1 amp @ 120 V AC or 28 V DC. See page 8 for additional ratings.
<b>Electrical Life</b>	TP11, TP21 models: 60,000 make-and-break cycles at full load. TP12 models: 30,000 cycles.
<b>Contact Resistance</b>	Below 20 mΩ 15 typ. initial @ 2-4 V DC, 100 mA, for both silver and gold plated contacts.
<b>Insulation Resistance</b>	10 <sup>9</sup> Ω 15 min.
<b>Dielectric Strength</b>	1000 Vrms min. @ sea level.
<b>Operating Temperature</b>	-30°C to 85°C
<b>Solderability</b>	Per MIL-STD-202F method 208D, or EIA RS-186E method 9 (1 hour steam aging).

#### Notes:

Any models supplied with Q, B, P, S, R or G contact material are RoHS compliant. Specifications and materials listed above are for switches with standard options. For information on specific and custom switches, consult Customer Service Center.

### Description

TP series of tiny pushbutton switches are used most often in telecommunications, networking and instrumentation applications. The TP switches are well-known for their subminiature size and ability to switch at 1 AMP. Snap-in front panel mounting is available, as are vertical and right angle terminations – and their epoxy terminal seal is compatible with bottom wash cleaning.

### Features & Benefits

- Sealed against solder & cleaning processes
- Through-hole and surface mount models
- Snap-fitting actuator accepts standard caps
- Tape & reel packaging available
- RoHS compliant models available

### Applications

- Telecommunications and networking equipment
- Computers and peripherals
- Instrumentation and controls

### Materials

<b>Case</b>	Glass filled nylon 4/6 or 6/6, flame retardant, heat stabilized or diallyl phthalate (DAP), (UL 94V-0).
<b>Plunger</b>	Thermoplastic polyester (UL 94V-0).
<b>Cap &amp; Frame</b>	Nylon, black standard
<b>Bushing</b>	Brass, nickel plated.
<b>Housing</b>	Stainless steel
<b>Switch Support</b>	Brass, matte-tin plated.
<b>End Contacts</b>	B contact material: Copper alloy, with gold plate over nickel plate. Q contact material: Coin silver, silver plated. See page 8 for additional contact materials.
<b>Center Contacts &amp; All Terminals</b>	B contact material: Copper alloy, with gold plate over nickel plate. Q contact material: Copper alloy, silver plated. See page 8 for additional contact materials.
<b>Terminal Seal</b>	Epoxy. Refer to soldering and cleaning in Technical Data Chapter
<b>Hardware</b>	Nut & Locking Ring: Brass nickel plated. Lockwasher: Steel, nickel plated.

# TP Series

## Tiny Pushbutton Switches



### Ordering Number

To order, simply select desired option from each category and place in the appropriate box. Available options are shown and described on pages 2-10. For additional options not shown in catalog, consult Customer Service Center. All models have epoxy terminal seal and are compatible with all "bottom-wash" PCB cleaning methods.

**X - X - X - X - X - X - X**

**Switch Function**

**TP11:** SPST Off-Mom.  
**TP12:** SPDT On-Mom.  
**TP21:** DPST Off-Mom.

**Actuator or Bushing**

**SH:** .155" high plunger, threaded,  
 .220" high bushing, flat  
**SH8:** .155" high plunger, unthreaded,  
 .220" high bushing, round  
**SH9:** .155" high plunger, unthreaded,  
 .220" high bushing, flat  
**J81:** Snap-in with frame  
**LT:** .215" high plunger, threaded,  
 .310" high bushing, flat  
**LT9:** .215" high plunger, unthreaded,  
 .310" high bushing, flat  
**MS9:** .130" high plunger,  
 .020" high bushing, round

**Terminations**

**A:** Right angle, PC Thru-hole  
**C:** PC Thru-hole  
**Z:** Solder lug  
**AV:** Vertical right angle,  
 PC Thru-hole  
**V3:** Vertical mount, v-bracket  
**W:** Wire wrap

**Frame Color**

**2:** Black  
**None:** Models with no frame

**Cap Color**

**2:** Black  
**None:** Models with no cap  
**1:** White

**Seal**

**E:** Epoxy

**Contact Material**

**B:** Gold  
**P:** Gold, matte-tin  
**Q:** Silver  
**G:** Gold over silver  
**R:** Gold over silver, matte tin

### Switch Function

#### SPDT

No. Poles	Model Number	Switch Function		Connected Terminals		Schematic
		POS. 1	POS. 2	POS. 1	POS. 2	
		C&K marking on opposite side				
SP	TP11	OFF	MOM.	OPEN	1-3	
SP	TP12	ON	MOM.	2-1	2-3	

### Dimensions inches (mm)

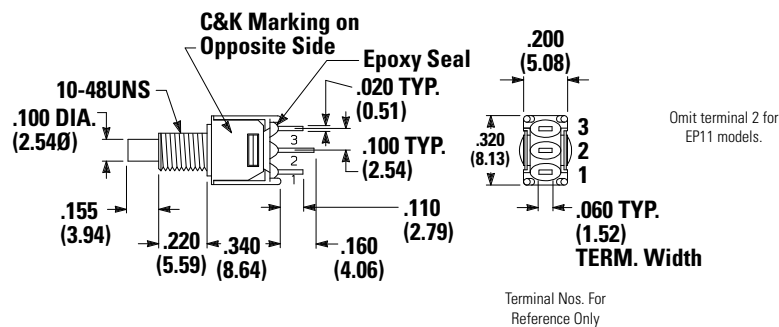

Part Number Shown: TP12SHZQE

# TP Series

## Tiny Pushbutton Switches



### DPST

No. Poles	Mo. Poles	Switch Function		Connected Terminals		Schematic
		POS. 1	POS. 2	POS. 1	POS. 2	
		C&K marking on opposite side				
DP	TP21	OFF	MOM.	OPEN	1-3, 4-6	

### Dimensions inches (mm)

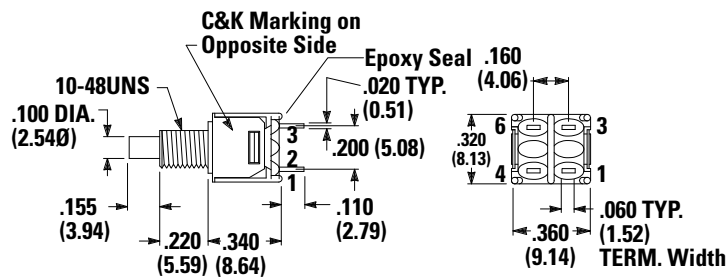

Note: Part Number Shown: TP21SHZQE

MOM. = Momentary All models C&K us with all options when ordered with G, Q or R contact material.

Terminal Nos. For Reference Only

### Actuator Snap-in Front Mount

#### J81 Snap-in with Frame

#### Dimensions inches (mm)

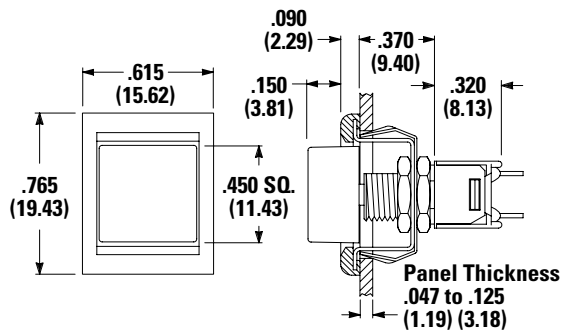

Option Code	Cap Color
2	Black
1	White

Option Code	Frame Color
2	Black
None	No Frame Color (J80 option)

#### Panel Mounting

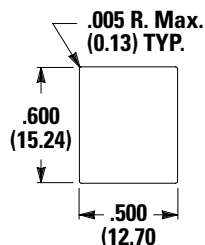

**Notes:**

Caps & Frames available separately, see page 8. Cap and Frame Finish: matte. Other colors available, consult Customer Service Center. Available with Z, C, or W terminations.

# TP Series

## Tiny Pushbutton Switches



### Bushing

**SH 0.155" High Plunger**  
**0.220" High Bushing,**  
**Threaded, Flat**

**Dimensions inches (mm)**

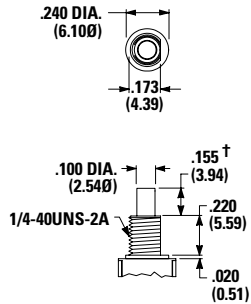

**Notes:**  
 Standard with Z, C, W terminations.

**SH8 0.155" High Plunger**  
**0.220" High Bushing,**  
**Unthreaded**

**Dimensions inches (mm)**

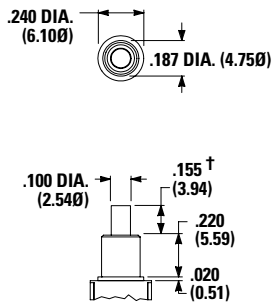

**Notes:**  
 Standard with A, AV, V3 terminations.  
 † Subtract .016 (0.41) for models with A, AV or V3 terminations.  
 Caps available for plunger options, see page 8.

**SH9 0.155" High Plunger**  
**0.220" High Bushing,**  
**Unthreaded, Flat**

**Dimensions inches (mm)**

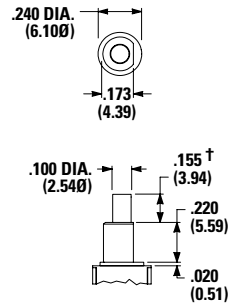

**LT 0.21517" High Plunger, 0.310" High Bushing, Threaded**  
**LT9 0.21517" High Plunger, 0.310" High Bushing, Unthreaded**  
**Dimensions inches (mm)**

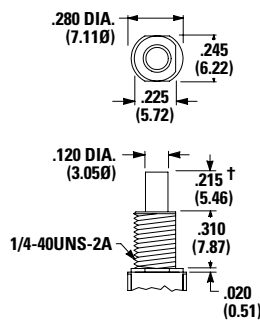

**MS9 0.130" High Plunger**  
**Dimensions inches (mm)**

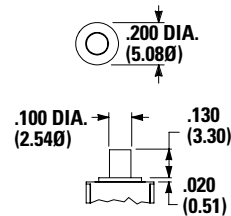

**Note:** Not available with Z terminations.

### Panel Mounting

**10-48 Bushing**  
**Dimensions inches (mm)**

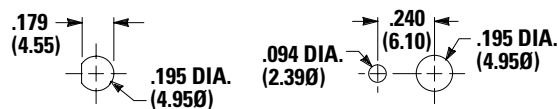

**Without locking ring**

**With standard locking ring**

**1/4 In. Bushing**  
**Dimensions inches (mm)**

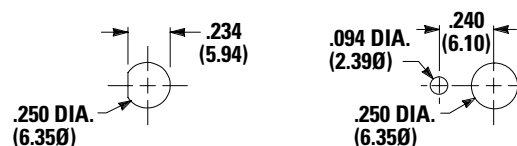

**Without locking ring**

**With standard locking ring**

**Notes:**  
 One mounting nut, locking ring and lockwasher supplied standard with 10-48 threaded bushings (two nuts with 1/4-40 bushings). Optional mounting nut and locking ring styles and finishes available separately, see section "Technical Data and Additional Hardware".

# TP Series

## Tiny Pushbutton Switches



### Terminations

**C PCThru-hole**  
Dimensions inches (mm)

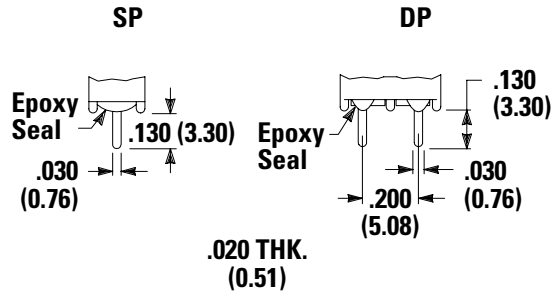

**Z Solder Lug**  
Dimensions inches (mm)

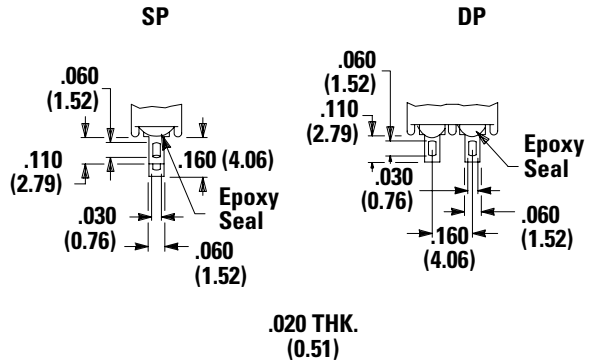

Note: Not available with MS9 bushing or P or R contact material.

**PC Mounting**

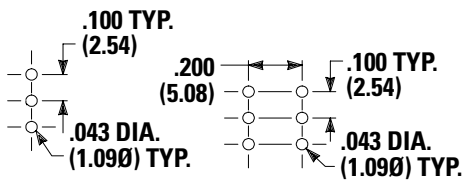

Omit center holes  
for TP11 models

**W Wire Wrap**  
Dimensions inches (mm)

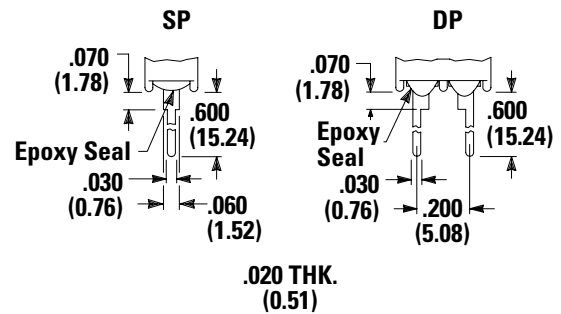

**A Right Angle, PCThru-hole**  
TP12SH9ABE SPDT

Dimensions inches (mm)

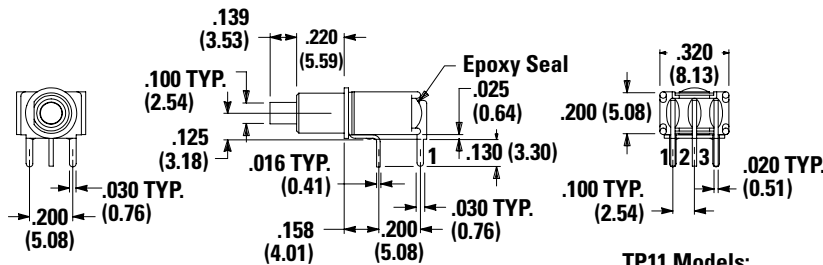

TP11 Models:  
omit terminal 2.

**PC Mounting**

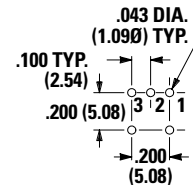

TP11 Models:  
omit hole 2.

# TP Series

## Tiny Pushbutton Switches



### A Right Angle, PC Thru-hole TP21SH9ABE DPST

Dimensions inches (mm)

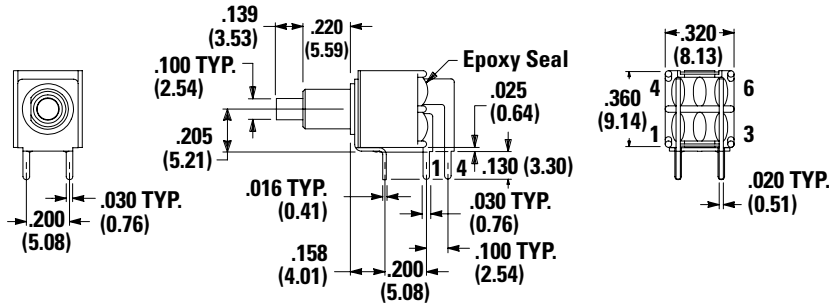

### PC Mounting

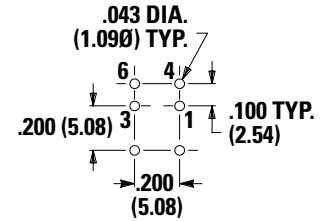

### AV Vertical Right Angle, PC Thru-hole TP12SH9AVBE SPDT

Dimensions inches (mm)

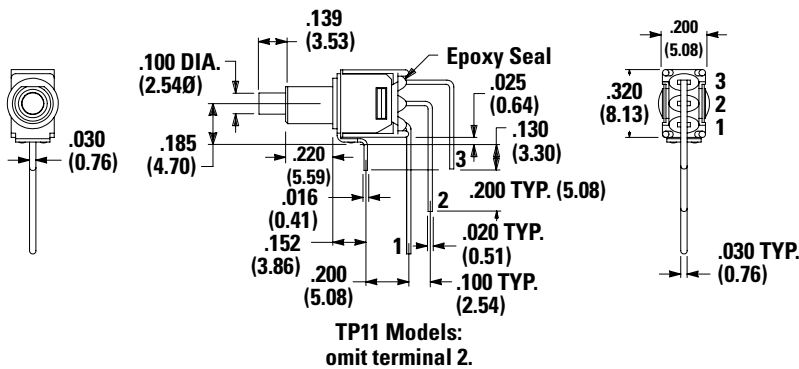

### PC Mounting

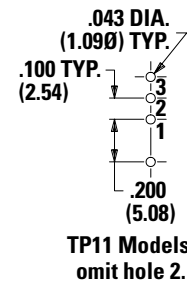

Notes:  
Terminal bend radii and lead-in manufacturing option.

### AV Vertical Right Angle, PC Thru-hole TP21SH9AVBE DPST

Dimensions inches (mm)

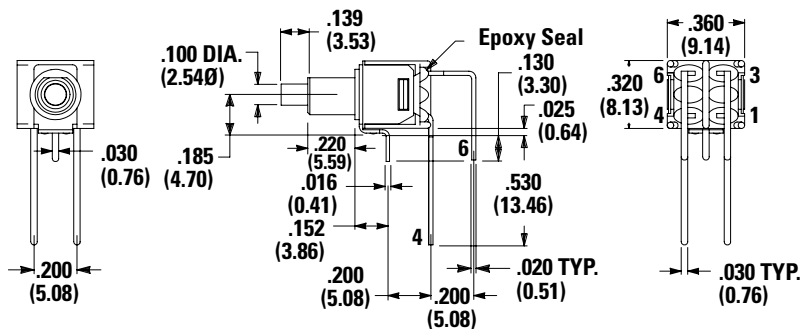

### PC Mounting

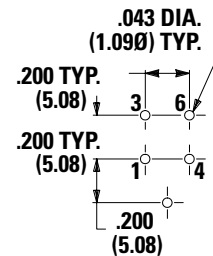

Note: Terminal bend radii and lead-in manufacturing option.

# TP Series

## Tiny Pushbutton Switches



### V3 Vertical Mount, V-Bracket TP12SH9V3BE SPDT

Dimensions inches (mm)

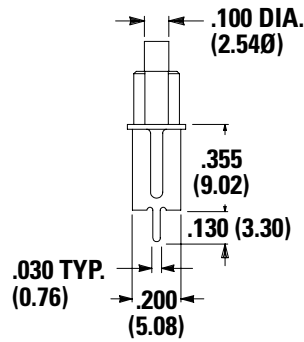
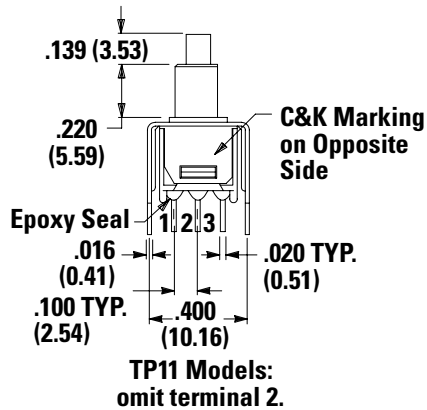

PC Mounting

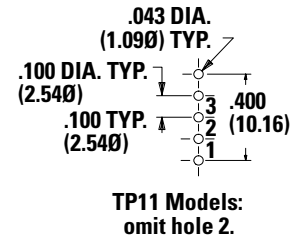

### V3 Vertical Mount, V-Bracket TP21SH9V3BE DPST

Dimensions inches (mm)

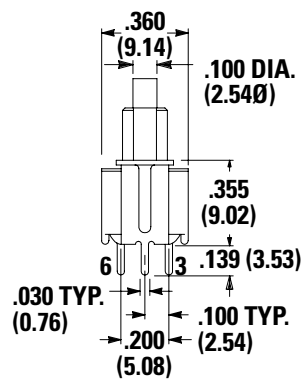
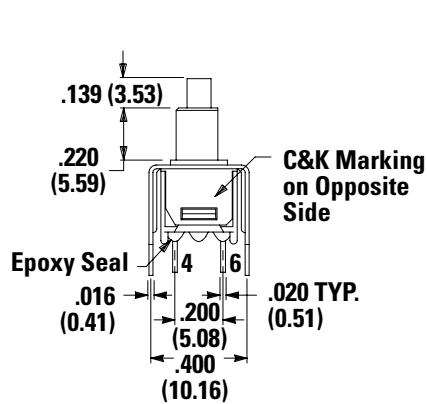

PC Mounting

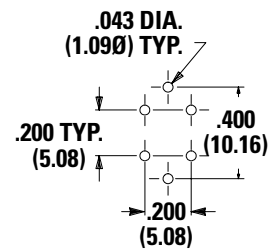

# TP Series

## Tiny Pushbutton Switches



### Contact Material

Option Code	Contact Material	Terminal Plating	Ratings	
B	Gold <sup>1</sup>	Gold <sup>1</sup>	Low Level/Dry Circuit	0.4 VA Max. @ 20 V AC or DC Max.
P		Matte-Tin <sup>6</sup>		
Q	Silver <sup>4,5</sup>	Silver <sup>5</sup>	Power	1 AMP @ 120 V AC or 28 V DC
G	Gold over Silver <sup>2,3</sup>	Gold <sup>3</sup>	Low Level/Dry Circuit or Power	0.4 VA Max @ 20 V AC or DC Max. or 28 V DC
R		Matte-Tin <sup>6</sup>		

**Notes:**

See Technical Data section of this catalog for RoHS compliant and compatible definitions and specifications.

1. Contacts & Terminals: Copper alloy, with gold plate over nickel plate.

2. End Contacts: Coin silver, with gold plate over nickel plate.

3. Center Contacts & All Terminals: Copper alloy, with gold plate over nickel plate.

4. End Contacts: Coin silver, silver plated.

5. Center Contact & All Terminals: Copper alloy, silver plated.

6. Terminals: Copper alloy, with matte tin over nickel plate.

Any models supplied with P, R, Q, B or G contact material are RoHS compliant. All models with all options when ordered with R, G, or Q contact material. B contact material standard with A, AV, V3 & W terminations. Q contact material standard with C & Z terminations. P, R contact materials not available with Z terminations.

### Seal

#### E Epoxy Seal

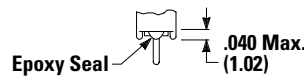

### Available Hardware

#### Cap, 0.100" DIA. Plungers

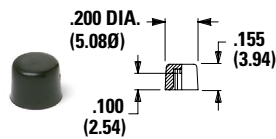

**PART NO.**  
508101000 WHITE  
508102000 BLACK  
**Material:** Nylon  
**Finish:** Gloss

#### Cap, 0.100" DIA. Plungers (Recommended for S9 plunger)

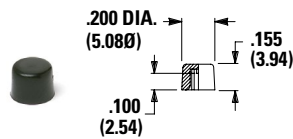

**PART NO.**  
538701000 WHITE  
538702000 BLACK  
**Material:** Nylon  
**Finish:** Gloss

#### Cap, 0.100" DIA. Plungers

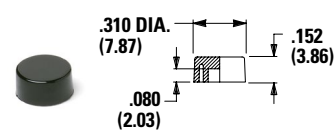

**PART NO.**  
465801000 WHITE  
465802000 BLACK  
**Material:** Nylon  
**Finish:** Gloss

# TP Series

## Tiny Pushbutton Switches



Cap, 0.120" DIA.  
Plungers

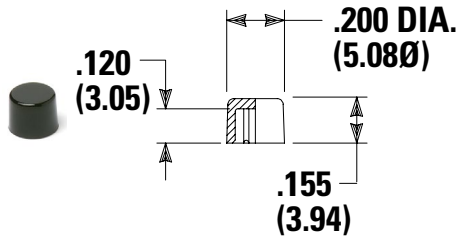

**PART NO.**  
708901000 WHITE  
708902000 BLACK  
**Material:** Nylon  
**Finish:** Gloss

Cap, 0.120" DIA.  
Plungers

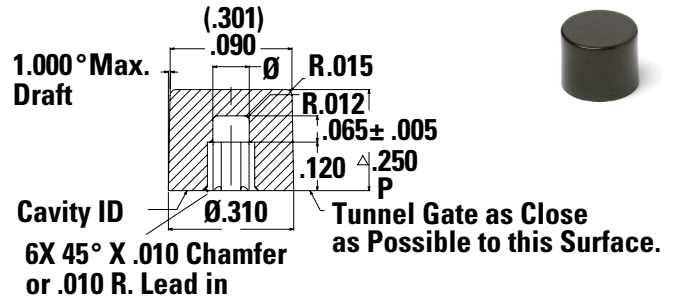

**PART NO.**  
891D01000 WHITE  
891D02000 BLACK  
**Material:** Nylon  
**Finish:** Gloss

Cap, J81 option only

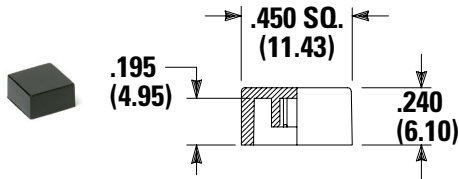

**PART NO.**  
484601000 WHITE  
484602000 BLACK  
**Material:** Nylon  
**Finish:** Gloss

**PART NO.**  
798201000 WHITE  
798202263 BLACK  
**Material:** Nylon  
**Finish:** Matte

**Note:** Additional nuts, locking rings and lockwashers available separately, see section "Technical Data and Additional Hardware". Other cap colors available, consult Customer Service Center.

# TP Series

## Tiny Pushbutton Switches



### Available Hardware

Frames snap into panel opening and are independent from switch mounting. Accurate positioning of the PC mounted switch relative to the panel opening is necessary to provide proper clearance between actuator and frame. Available in two basic styles and four panel thicknesses .047-.125 in. Material: Nylon. Finish: Matte.

### Typical Application

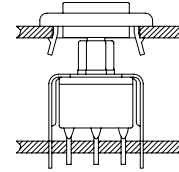

### Dimensions



### Panel Mounting

**For Part Numbers**  
432502263. 432602263

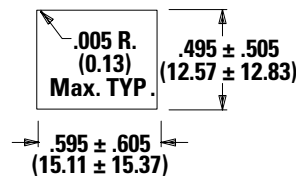

0.090" (2.29) PANEL THK.  
**PART NO.** 432702263

**For Part Numbers**  
432702263. 432802263

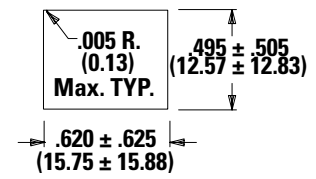

0.125" (3.18) PANEL THK.  
**PART NO.** 432802263  
BLACK

Above frames (part nos. 432XXXXXX) are also available with insert which accepts LED for indicator light assembly. Order insert separately from frame. Blank insert panel (without hole for LED) also available. LED not included.

### Panel Inserts

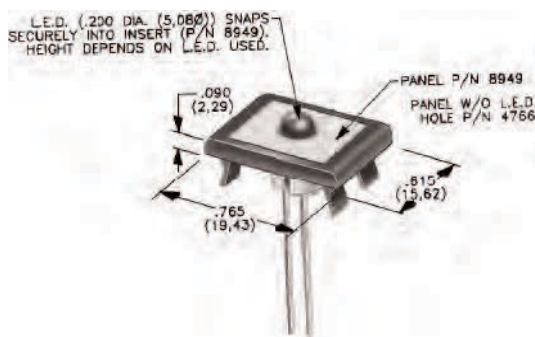

Panel Insert with Hole for LED **Part No.** 894902000

Blank Panel Insert without Hole for LED **Part No.** 476602000 Black

**Disclaimer Notice** - Information furnished is believed to be accurate and reliable. However, users should independently evaluate the suitability of and test each product selected for their own applications. Littelfuse products are not designed for, and may not be used in, all applications. Read complete Disclaimer Notice at <http://www.littelfuse.com/disclaimer-electronics>.

## Looking for pricing, stock, or lifecycle information?

Click below to explore more details on WIN SOURCE:

 [View TP12SH9V3BE](#) on WIN SOURCE

 [C&K Components](#) Information

## Optimize Your Supply Chain with WIN SOURCE Solutions

-  Global Sourcing Solution
-  Obsolete Management
-  Cost Control Management
-  Shortage Management
-  Alternative Solution
-  Excess Inventory Management