



THE DATASHEET OF RA-08-KIT





Ra-08-Kit Specification

Version V1.2.0

Copyright ©2022

Content

1. Product Overview	4
1.1. Characteristic	5
2. Main parameters	6
2.1. Power supply selection	6
2.2. Static electricity requirements	7
2.3. Electrical characteristics	7
2.4. Digital port characteristics	8
2.5. RF parameters	8
3. Appearance dimensions	9
4. Indicator light and button description	10
5. Pin definition	11
6. Schematic	13
7. Product related models	14
8. Product Packaging Information	15
9. Contact us	15
Disclaimer and copyright notice	16
Notice	16

1. Product Overview

Ra-08-Kit is a LoRaWAN development board designed and developed by Shenzhen Ai-Thinker Technology Co., Ltd. The development board is equipped with a LoRa module, and leads to serial ports and peripheral pins, which can be connected to the factory firmware through the The serial port assistant can easily send and receive LoRaWAN control by sending commands.

The chip ASR6601 on the development board is a general-purpose LPWAN wireless communication SoC that integrates an RF transceiver, a modem and a 32-bit RISC MCU. The MCU adopts ARM core, and the operating frequency can reach 48MHz. The Ra-08 module supports LoRa modulation and traditional (G)FSK modulation under the LPWAN use case; at the same time, the transmitter also supports BPSK modulation and (G)MSK modulation, and the receiver supports (G)MSK modulation.

The Ra-08 module on the development board provides ultra-long range and ultra-low power communication for LPWAN applications, which can be widely used in smart meters, supply chain and logistics, home building automation, security systems, remote irrigation systems and other scenarios.

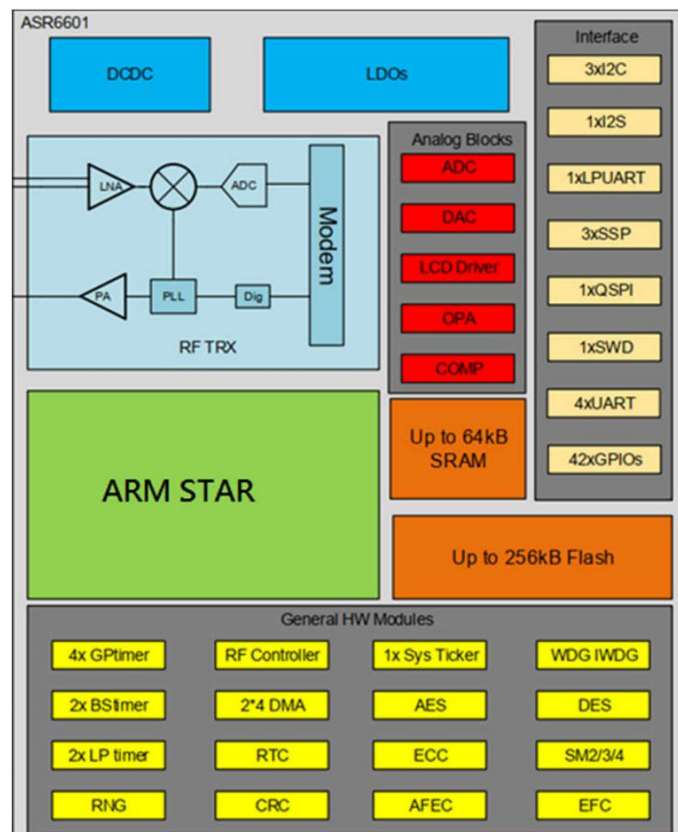

Figure 1 Main chip architecture diagram

1.1. Characteristic

- Adopt DIP-30 package
- Interface type: standard micro USB + 2.54mm pitch pin header
- Support frequency: 410MHz-525MHz
- Working voltage is 5V, theoretical maximum transmit power: +22dBm
- High sensitivity:-138dBm @125Kz SF12
- Support spread spectrum factor SF5/SF6/SF7/SF8/SF9/SF10/SF11/SF12
- Embedded memory, 128KB FLASH,16KB SRAM
- Support LoRa/(G)FSK/BPSK/(G)MSK modulation
- Support multiple sleep modes: depth sleep current is low to 0.9uA
- Support external antenna, the antenna uses SMA interface

2. Main parameters

Table 1 Description of the main parameters

Development board model	Ra-08-Kit
Suitable module	Ra-08
Package	DIP-30
Size	25.40*48.26(±0.2)mm
Antenna	External SMA
Frequency	410-525MHz
Operating temperature	-40 °C ~ 85 °C
Storage temperature	-40 °C ~ 125 °C , < 90%RH
Power supply	Voltage 5V, Current >500mA
Interface	UART/GPIO/ADC/DAC/I2C/I2S/SPI/PWM
IO	IO2,IO4,IO5,IO8,IO9,IO11,IO14,IO15
UART rate	Low-speed serial port, default 9600 bps
Transfer Protocol	LoRaWAN, LinkWAN
SPI Flash	128KB

2.1. Power supply selection

You can choose one of the following two power supply methods to power the Ra-08-Kit:

- Micro-USB interface power supply (default)
- 3V3 and GND or 5V and GND pin header power supply

It is recommended to choose the first power supply method: Micro-USB interface power supply.

2.2. Static electricity requirements

Ra-08-Kit development board is a static-sensitive device and requires special precautions when handling it.



Figure 2 ESD anti-static diagram

2.3. Electrical characteristics

Table 2 Electrical characteristics table

Parameter	Name	Min.	Typical value	Max.	Unit	Remark	
Operating temperature	TOPR	-40	25	85	°C	Industrial grade design	
Interface power supply (Micro-USB)	VCC	4.75	5	5.25	V		
Supply voltage (Pin)	VCC	2.7	3.3	3.6	V	≥3.3V can guarantee output power	
Power consumption	Sleep mode	Power consumption 1	-	0.9	-	uA	0.9uA@Without RF/MCU Retention, Without RTC
		Power consumption 2	-	1.3	-	uA	1.3uA@With RF/MCU Retention and RTC
	Standby mode	-	3.83	-	mA	Power on	
	Full load mode (TX:21dBm)	-	115	-	mA	DC-DC used, 21dBm	
	Receive mode (RX:SF10)	-	9.5	-	mA	DC-DC used	

2.4. Digital port characteristics

Table 3 Digital port

Description		Typical value			Unit
Working frequency		410~525			MHz
Port	Name	Min.	Typical value	Max.	Unit
IO level	VIO	2.7	3.3	3.6	V
Enter logic level low	VIL	-	-	0.2	V
Enter logic level high	VIH	0.8	-	-	V
Output logic level low	VOL	-	-	0.1	V
Output logic level high	VOH	0.9	-	-	V

2.5. RF parameters

Table 4 RF parameters

Description		Typical value			Unit
Output Power					
Mode	Frequency band	Min.	Typical value	Max.	Unit
Transmit	433MHz	-	21	-	dBm
Transmit	470MHz	-	21	-	dBm
Transmit	490MHz	-	21	-	dBm
Transmit	510MHz	-	21	-	dBm
Receive sensitivity modulation bandwidth 125kHz					
Mode		Min.	Typical value	Max.	Unit
SF7		-	-123	-	dBm
SF8		-	-126	-	dBm
SF9		-	-128	-	dBm
SF10		-	-131	-	dBm
SF11		-	-135	-	dBm
SF12		-	-138	-	dBm

3. Appearance dimensions

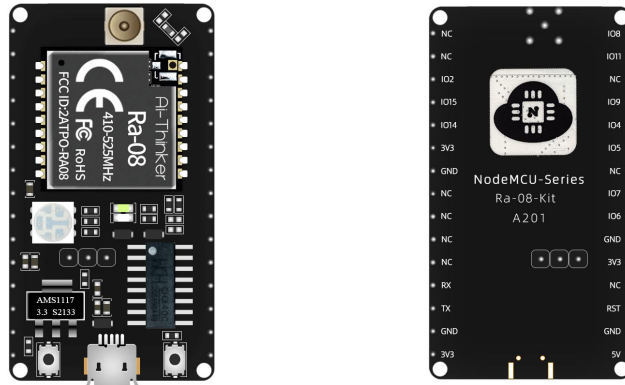

Figure 3 Appearance of the development board (the picture and silk screen are for reference only, the actual product shall prevail)

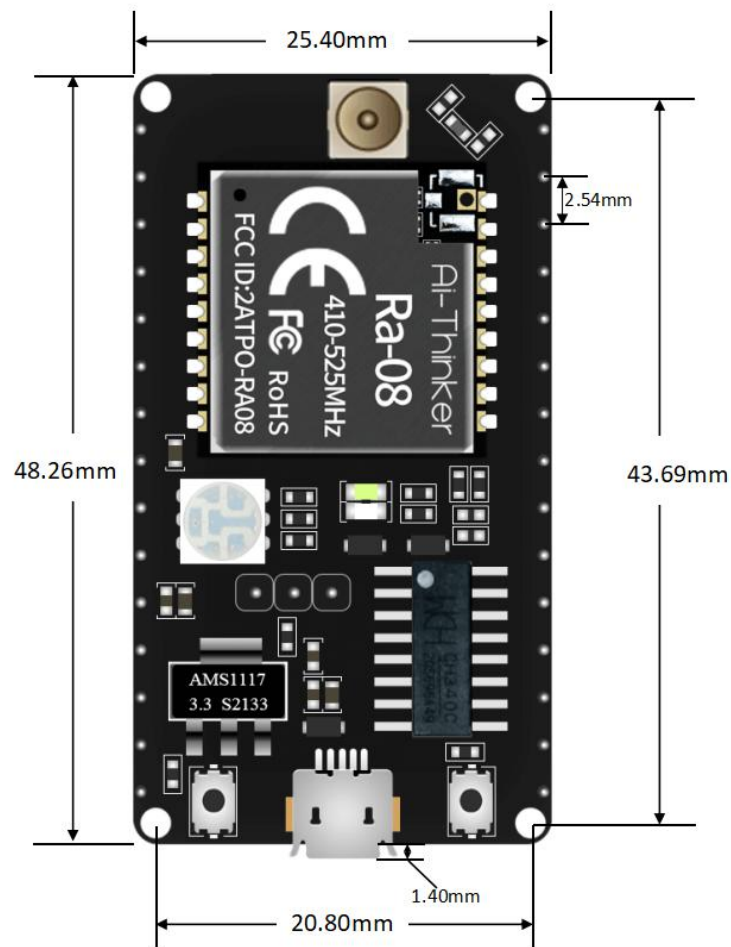

Figure 4 Development Board Dimensions

4. Indicator light and button description

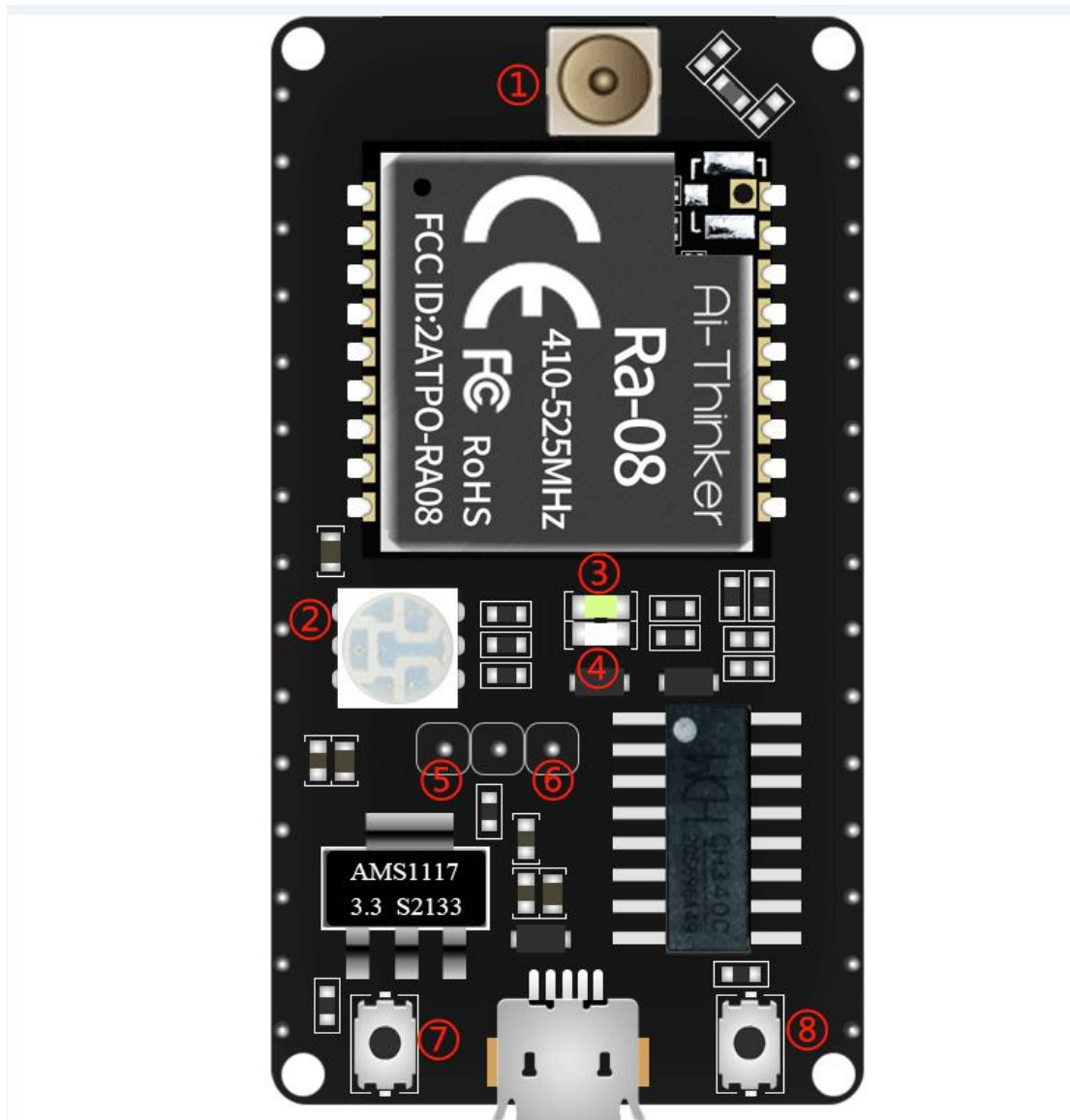

Figure 5 Ra-08-Kit indicator and key position

Table 4 Ra-08-Kit Indicators and Button Locations

①	SMA base
②	RGB light (IO7、IO5、IO4)
③	Cool light (IO14)
④	Warm light (IO15)
⑤	Flash serial port
⑥	AT serial port
⑦	Reset button
⑧	Flash button

5. Pin definition

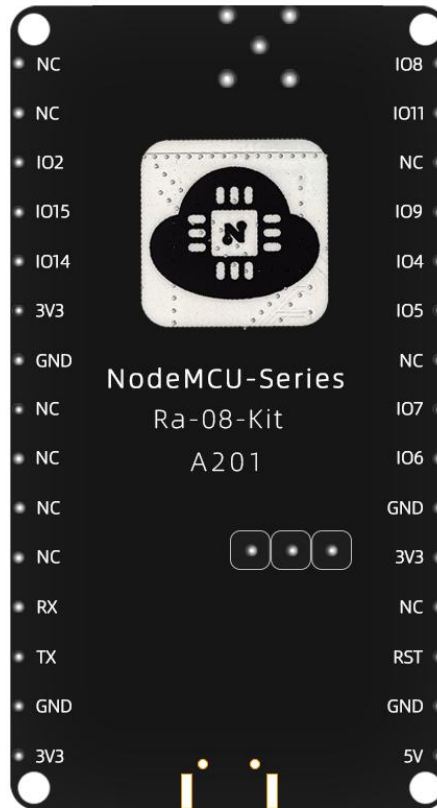

Figure 6 Schematic diagram of development board pins (bottom view)

Ra-08-Kit has a total of 30 interfaces, such as the pin diagram, the pin function definition table is the interface definition.

Table 5 Pin function definition table

No.	Name	Function
1	IO8	GPIO8/ADC_IN1
2	IO11	GPIO11/ADC_IN0
3	NC	NC
4	IO9	GPIO9/DAC_OUT
5	IO4	GPIO4/SSP1_CLK
6	IO5	GPIO5/SSP1_NSS
7	NC	NC
8	IO7	GPIO7/SWD_CLK

9	IO6	GPIO6/SWD_DATA
10	GND	Ground wire, connected to the power reference ground
11	3V3	3.3V power supply, recommended supply current > 500mA
12	NC	NC
13	RST	RSTN_IN External reset
14	GND	Ground wire, connected to the power reference ground
15	5V	5V power supply, recommended supply current > 500mA
16	3V3	3.3V power supply, recommended supply current > 500mA
17	GND	Ground wire, connected to the power reference ground
18	TX	GPIO17/UART TX
19	RX	GPIO60/LPUART-RX or GPIO16/UART RX
20	NC	NC
21	NC	NC
22	NC	NC
23	NC	NC
24	GND	Ground wire, connected to the power reference ground
25	3V3	3.3V power supply, recommended supply current > 500mA
26	IO14	GPIO14/I2C_SCL
27	IO15	GPIO15/I2C_SDA
28	IO2	GPIO2/BOOT
29	NC	NC
30	NC	NC

Table 6 Module startup mode description table

Pin	Default	SPI startup mode	Download start mode
IO2	drop down	0	1

Note: Some pins have been pulled up internally, please refer to the schematic diagram.

6. Schematic

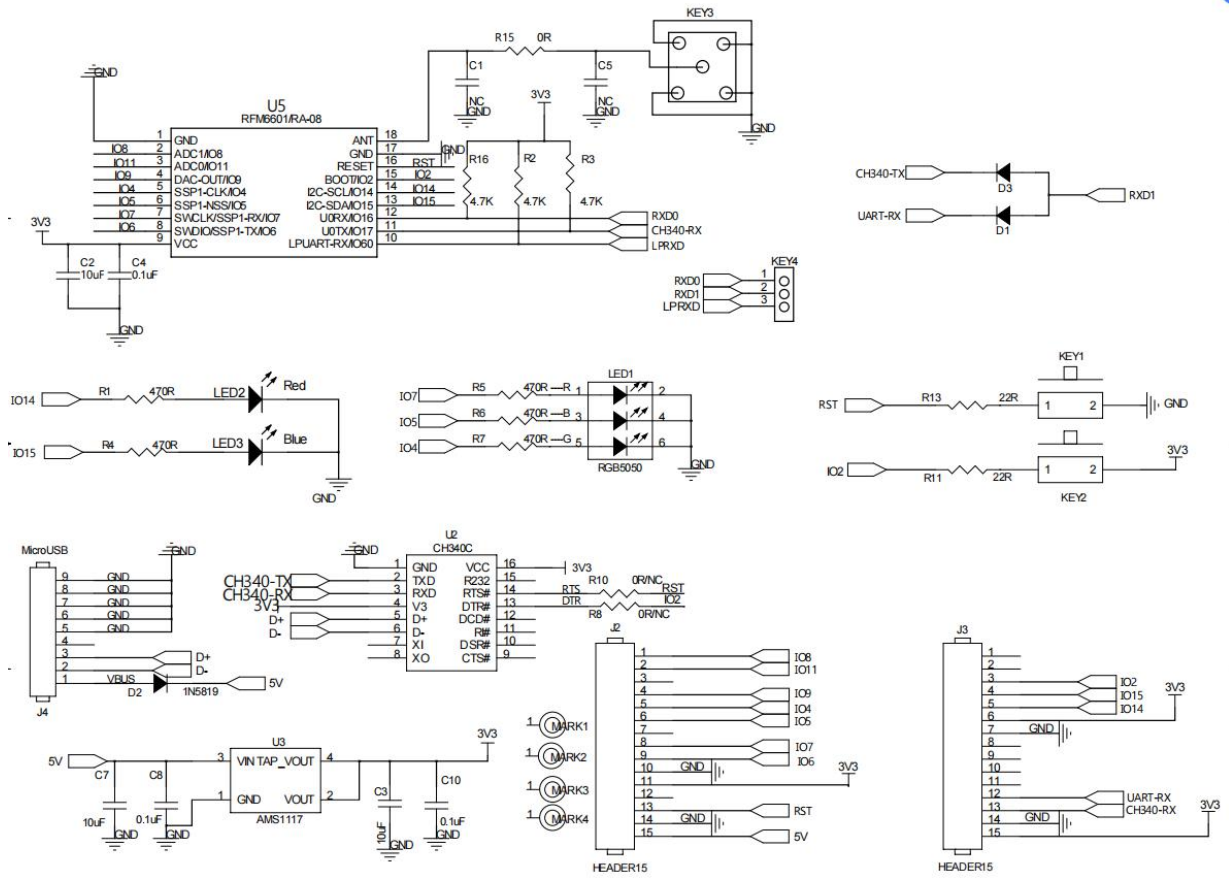

Figure 7 Schematic diagram of the development board

7. Product related models

Table 7 Product related model list

Model	Frequency band	Power supply	Package	Size	Antenna
Ra-08	410~525MHz	3.3V I>500mA	SMD-18	16*16 mm	Posts stamp pad/IPEX
Ra-08H	803~930MHz	3.3V I>500mA	SMD-18	16*16 mm	Posts stamp pad/IPEX
Ra-08-Kit	410~525MHz	5V, I>500mA	DIP-30	25.40*48.26(±0.2)mm	SMA-K
Ra-08H-Kit	803~930MHz	5V, I>500mA	DIP-30	25.40*48.26(±0.2)mm	SMA-K
Product related information: https://docs.ai-thinker.com/lr					

8. Product Packaging Information

Table 8 Packaging Information Sheet

Packing list	Packaging method	Quantity per pack (static bag)	Quantity per pack (sealed bag)
Ra-08-Kit	Foam + static bag	1pcs	20pcs

9. Contact us

[Ai-Thinker official website](#)

[Office forum](#)

[Develop DOCS](#)

[LinkedIn](#)

[Tmall shop](#)

[Taobao shop](#)

[Alibaba shop](#)

[Technical support email: support@aithinker.com](mailto:support@aithinker.com)

[Domestic business cooperation: sales@aithinker.com](mailto:sales@aithinker.com)

[Overseas business cooperation: overseas@aithinker.com](mailto:overseas@aithinker.com)

Company Address: Room 403,408-410, Block C, Huafeng Smart Innovation Port, Gushu 2nd Road, Xixiang, Baoan District, Shenzhen.

Tel: +86-0755-29162996



WeChat mini program

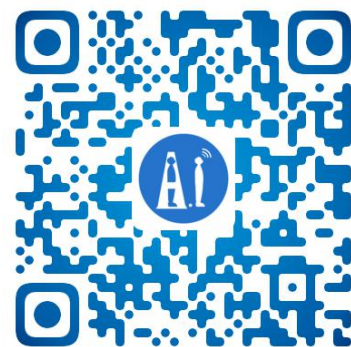

WeChat official account

Disclaimer and copyright notice

The information in this article, including the URL address for reference, is subject to change without notice.

The document is provided "as is" without any guarantee responsibility, including any guarantee for merchantability, suitability for a specific purpose, or non-infringement, and any guarantee mentioned elsewhere in any proposal, specification or sample. This document does not bear any responsibility, including the responsibility for infringement of any patent rights arising from the use of the information in this document. This document does not grant any license for the use of intellectual property rights in estoppel or other ways, whether express or implied.

The test data obtained in the article are all obtained from Ai-Thinker's laboratory tests, and the actual results may vary slightly.

All brand names, trademarks and registered trademarks mentioned in this article are the property of their respective owners, and it is hereby declared.

The final interpretation right belongs to Shenzhen Ai-Thinker Technology Co.,Ltd.

Notice



Due to product version upgrades or other reasons, the contents of this manual may be changed.

Shenzhen Ai-Thinker Technology Co.,Ltd. reserves the right to modify the contents of this manual without any notice or prompt.







This manual is only used as a guide. Shenzhen Ai-Thinker Technology Co.,Ltd. makes every effort to provide accurate information in this manual. However, Shenzhen Ai-Thinker Technology Co.,Ltd. does not guarantee that the contents of the manual are completely free of errors. All statements and information in this manual and the suggestion does not constitute any express or implied guarantee.

Looking for pricing, stock, or lifecycle information?

Click below to explore more details on WIN SOURCE:

-  [View RA-08-KIT on WIN SOURCE](#)
-  [Ai-Thinker Information](#)

Optimize Your Supply Chain with WIN SOURCE Solutions

-  Global Sourcing Solution
-  Obsolete Management
-  Cost Control Management
-  Shortage Management
-  Alternative Solution
-  Excess Inventory Management