



**THE DATASHEET OF
Z4GP206L-HF**



Z4GP206L-HF Thru. Z4GP210L-HF

Reverse Voltage: 600 to 1000 Volts

Forward Current: 2.0 A

RoHS Device

Halogen free

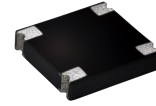

Features

- Internal structure with GPRC (Glass passivated rectifier chip) inside.
- Lead less chip form, no lead damage.
- Low power loss, High efficiency.
- High current capability.
- Plastic package has Underwriters Laboratory Flammability Classification 94V-0 .

Mechanical data

- Case: Packed with FRP substrate and epoxy underfilled.
- Terminals: Pure Tin plated (Lead-Free), solderable per MIL-STD-750, method 2026.
- Polarity: Laser marking symbols
- Weight: 0.11 gram

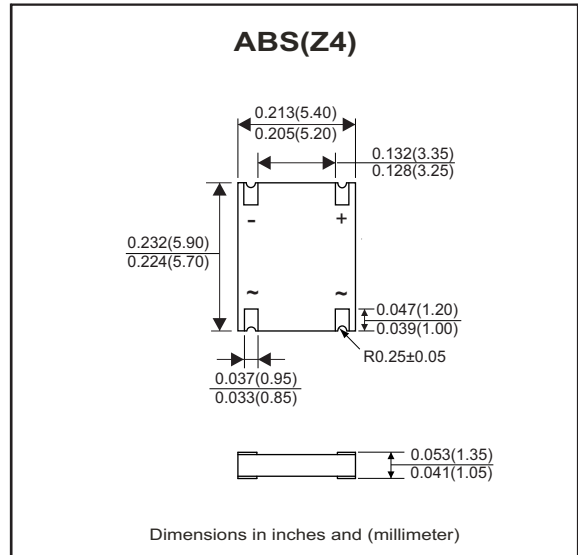

Circuit Diagram

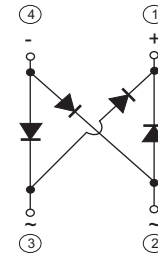

Absolute Maximum Rating (at TA=25°C unless otherwise noted)

Parameter	Symbol	Z4GP206L-HF	Z4GP208L-HF	Z4GP210L-HF	Unit
Repetitive Peak Reverse Voltage	V _{RRM}	600	800	1000	V
Average Forward Current	I _(AV)	2.0			A
Peak Forward Surge Current, 8.3mS single half sine-wave, superimposed on rated load (JEDEC Method)	I _{FSM}	60			A
Operating Temperature Range	T _J	-55 to +175			°C
Storage Temperature Range	T _{STG}	-55 to +175			°C

Electrical Characteristics (at TA=25°C unless otherwise noted)

Parameter	Symbol	Conditions	Min.	Typ.	Max.	Unit
Forward Voltage	V _F	I _F = 2.0A	-	0.92	0.95	V
Repetitive peak reverse current	I _{RRM}	V _R =Max. V _{RRM} , T _a =25°C	-	0.08	5	uA
Current squared time	I ² t	t<8.3ms, T _a = 25°C	-	14.9	-	A ² S
Junction capacitance	C _J	V _R =4V, f=1.0MHz	-	35	-	pF
Thermal resistance	R _{th(JA)}	Junction to ambient (Note)	-	80	-	°C/W
	R _{th(JL)}	Junction to lead (Note)	-	20	-	°C/W

Notes: 1. Mounted on P.C.B with 1.5*1.0mm copper pads..

Company reserves the right to improve product design , functions and reliability without notice.

REV:A

RATING AND CHARACTERISTIC CURVES (Z4GP206L-HF Thru. Z4GP210L-HF)

Fig.1- Forward Current Derating Curve

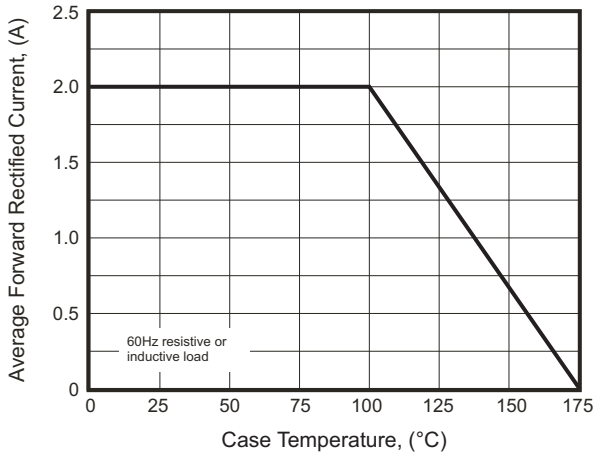

Fig.2- Maximum Non-Repetitive Peak Forward Surge Current

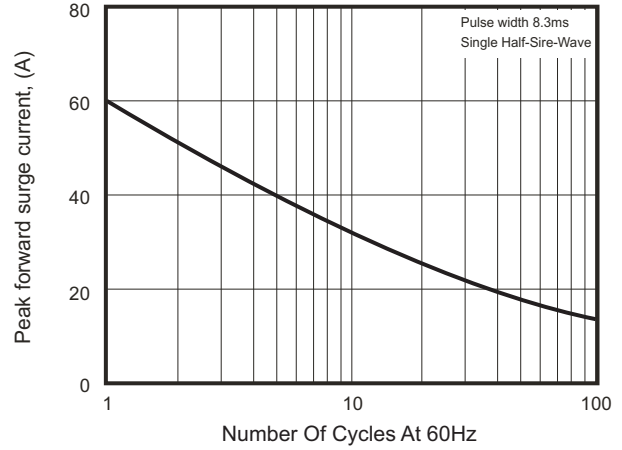

Fig.3- Typical Instantaneous Forward Characteristics

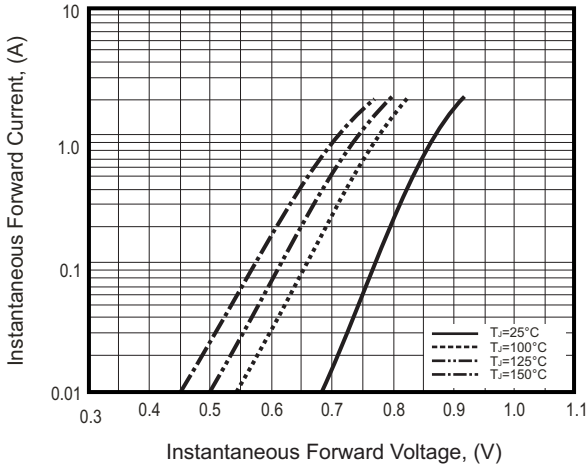

Fig.4- Typical Reverse Characteristics

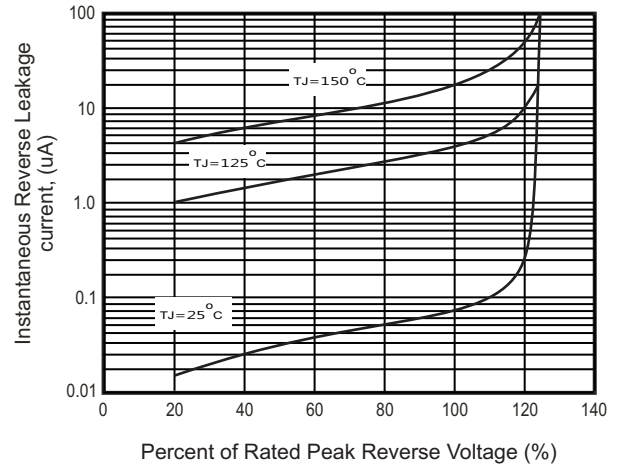
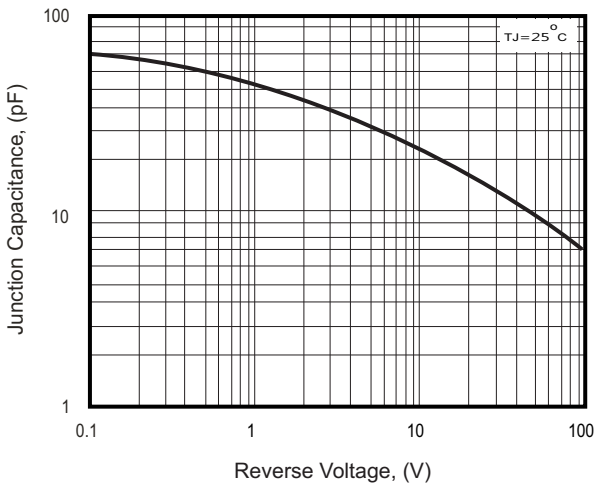

Fig.5 - Typical Junction Capacitance



Company reserves the right to improve product design, functions and reliability without notice.

REV:A

Reel Taping Specification

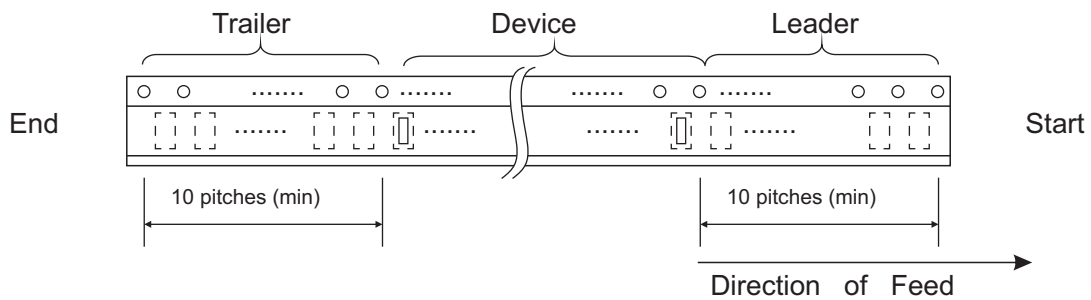
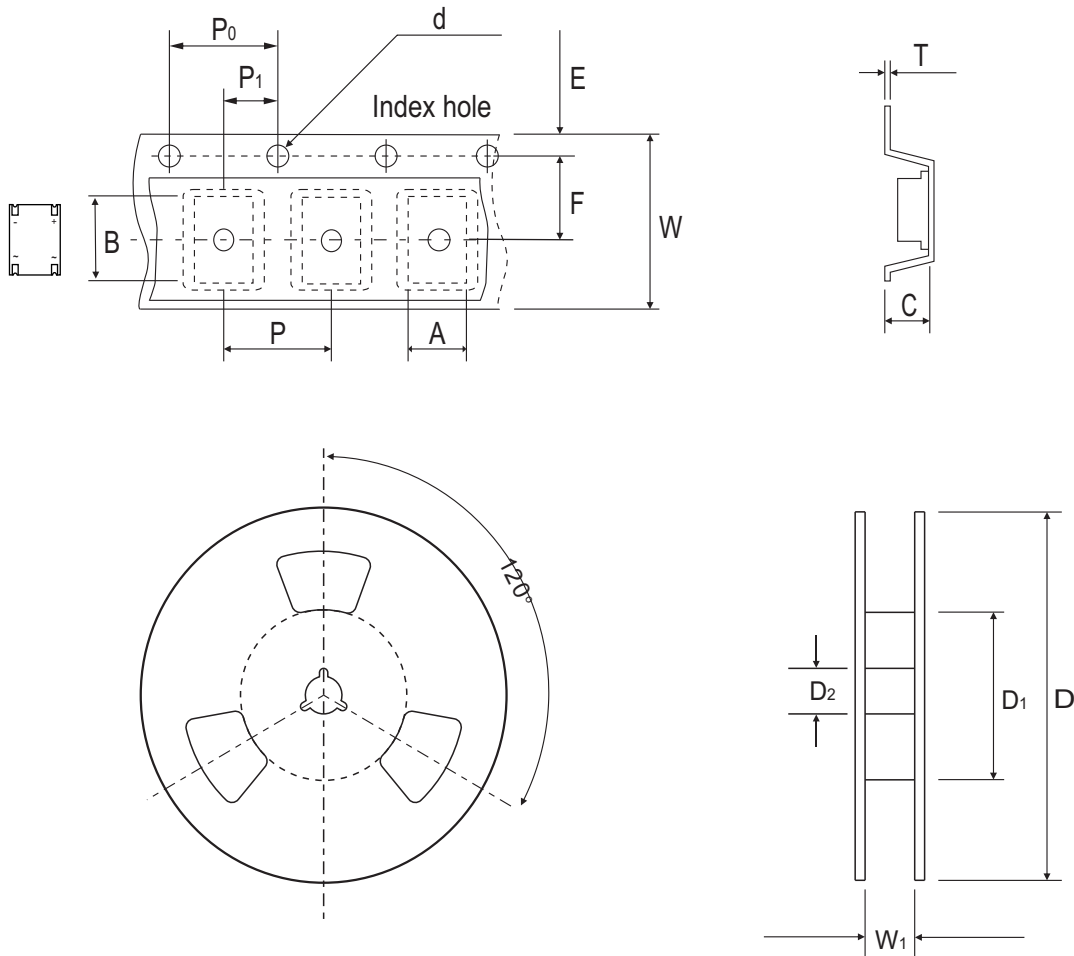

ABS(Z4)	SYMBOL	A	B	C	d	D	D ₁	D ₂
	(mm)	5.65 ± 0.10	6.15 ± 0.10	1.45 ± 0.10	1.50 ± 0.10	330 ± 2.00	50.0 MIN.	13.0 ± 0.50
	(inch)	0.222 ± 0.004	0.242 ± 0.004	0.057 ± 0.004	0.059 ± 0.004	12.992 ± 0.079	1.969 MIN.	0.512 ± 0.020

ABS(Z4)	SYMBOL	E	F	P	P ₀	P ₁	W	W ₁
	(mm)	1.75 ± 0.10	5.50 ± 0.05	8.00 ± 0.10	4.00 ± 0.10	2.00 ± 0.10	12.00 ± 0.30	14.4 MAX.
	(inch)	0.069 ± 0.004	0.217 ± 0.002	0.315 ± 0.004	0.157 ± 0.004	0.079 ± 0.004	0.472 ± 0.012	0.567 MAX.

Company reserves the right to improve product design, functions and reliability without notice.

Marking Code

Part Number	Marking Code
Z4GP206L-HF	Z4GP20JL
Z4GP208L-HF	Z4GP20KL
Z4GP210L-HF	Z4GP20ML

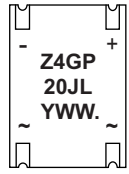

Z4GP = Series code
 20 = Amps class(2.0A)
 J = Voltage Class
 J = 600V
 K = 800V
 M = 1000V
 L = Low VF
 . = Halogen- free type

Y = Last digit of the year
 0 = 2010
 1 = 2011
 2 = 2012

WW = Mfg week
 01 = First week
 02 = Second week
 03 = Third week

Suggested PAD Layout

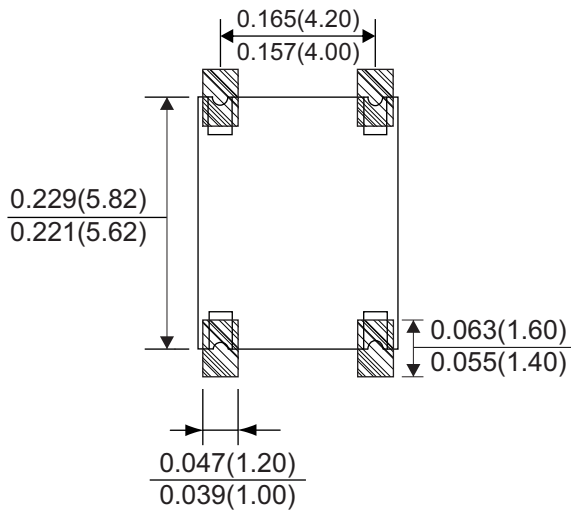

Standard Packaging

Case Type	REEL PACK	
	REEL (pcs)	Reel Size (inch)
ABS(Z4)	5,000	13

Looking for pricing, stock, or lifecycle information?

Click below to explore more details on WIN SOURCE:

- [View Z4GP206L-HF on WIN SOURCE](#)
- [Comchip Technology Information](#)

Optimize Your Supply Chain with WIN SOURCE Solutions

- ✓ Global Sourcing Solution
- ✓ Obsolete Management
- ✓ Cost Control Management
- ✓ Shortage Management
- ✓ Alternative Solution
- ✓ Excess Inventory Management