



THE DATASHEET OF CPDV3V0-HF



CPDV3V0-HF Thru. CPDV24V0-HF

RoHS Device
Halogen Free

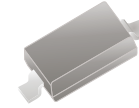

Features

- IEC61000-4-2 (ESD) $\pm 15\text{kV}$ (air), $\pm 8\text{kV}$ (contact).
- IEC61000-4-4 (EFT) 40A (5/50ns).
- IEC61000-4-5 (Lightning) 12A (8/20 μs).
- Protects one I/O line (bidirectional).
- Low clamping voltage.
- Working voltages: 3V~24V.
- Low leakage current.
- Response time is < 1ns.

Mechanical data

- Case: SOD-323 package.
- Flammability rating: UL 94V-0.
- High temperature soldering guaranteed: 260°C/10s.

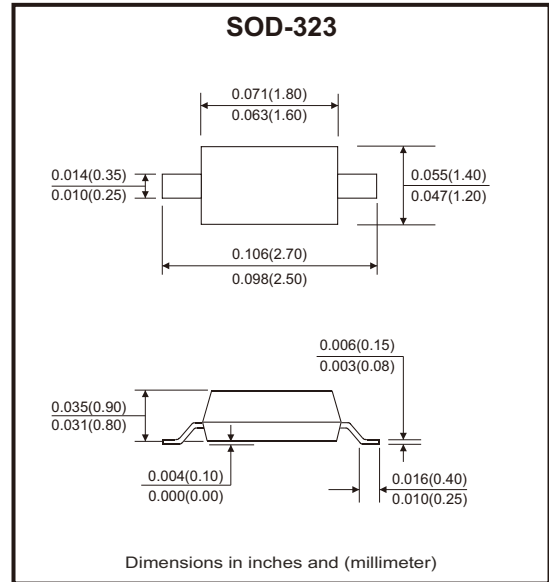

Circuit diagram

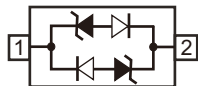

Maximum Rating (at Ta=25°C unless otherwise noted)

Parameter	Symbol	Value	Unit
ESD per IEC 61000-4-2 (air)	V _{ESD}	±15	kV
ESD per IEC 61000-4-2 (contact)		±8	
Peak pulse power (8/20 μs)	P _{PP}	350	W
Operating temperature range	T _{OPT}	-55 to +150	°C
Storage temperature range	T _{STG}	-55 to +150	°C
Lead soldering temperature	T _L	260	°C

Electrical Characteristics (at Ta=25°C unless otherwise noted)

Part No.	V _{RWM} (V) Max	V _B @1mA(V) Min	V _C @1A(V) Max	V _C @I _{PP} (V)		V _C @I _{PP} (V)		I _R (μA) Max	C _T (pF) Typ
				Max	I _{PP} (A)	Max	I _{PP} (A)		
CPDV3V0-HF	3	4.0	7.0	13.9	8	20.0	20	5	0.8
CPDV5V0-HF	5	6.0	9.8	18.3	8	20.0	18	1	0.8
CPDV8V0-HF	8	8.5	13.4	18.5	8	24.0	18	1	0.8
CPDV12V0-HF	12	13.3	19.0	24.0	6	28.6	12	1	0.8
CPDV15V0-HF	15	16.7	24.0	29.0	5	31.8	10	1	0.8
CPDV24V0-HF	24	26.7	43.0	45.0	3	56.0	6	1	0.8

Rating and Characteristic Curves (CPDV3V0-HF Thru. CPDV24V0-HF)

Fig.1 - Pulse Waveform

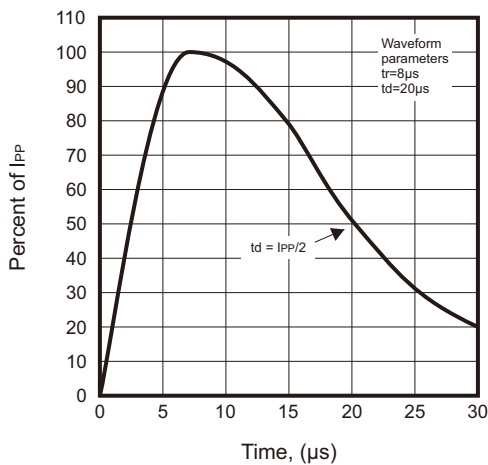

Fig.2 - Non-Repetitive Peak Pulse Power vs. Pulse Time

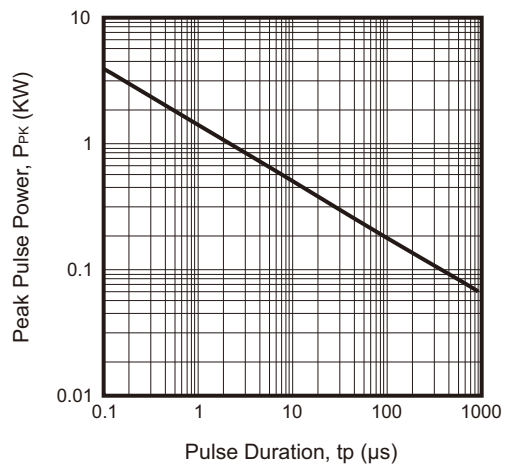

Fig.3 - Power Derating Curve

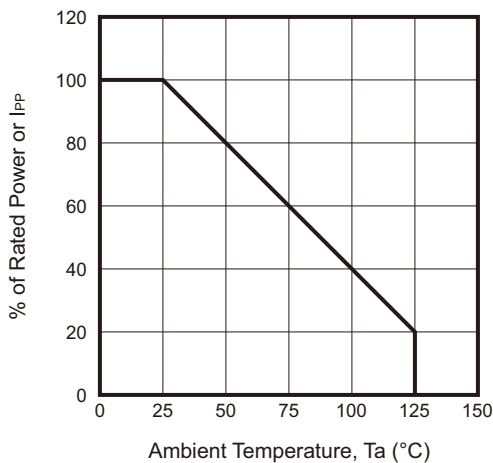
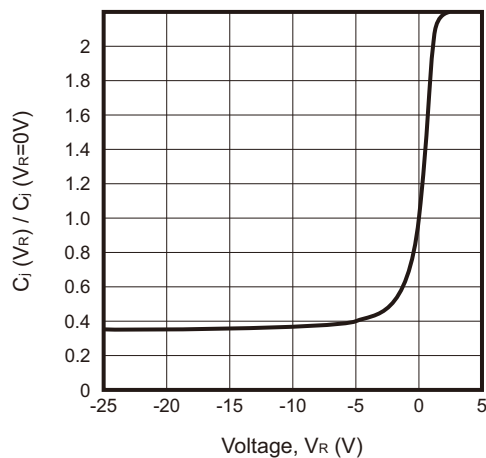
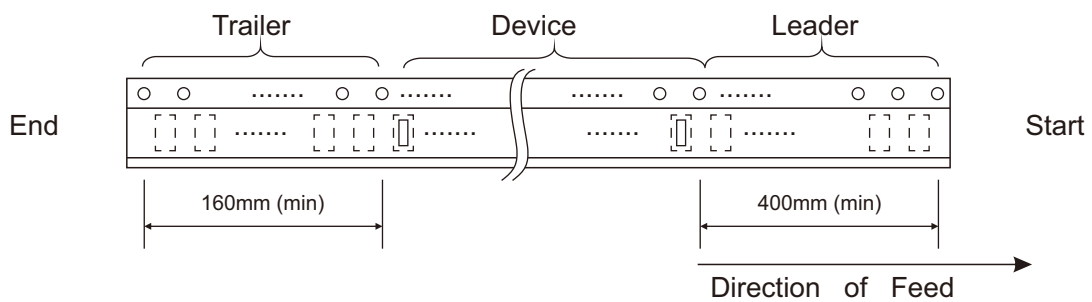
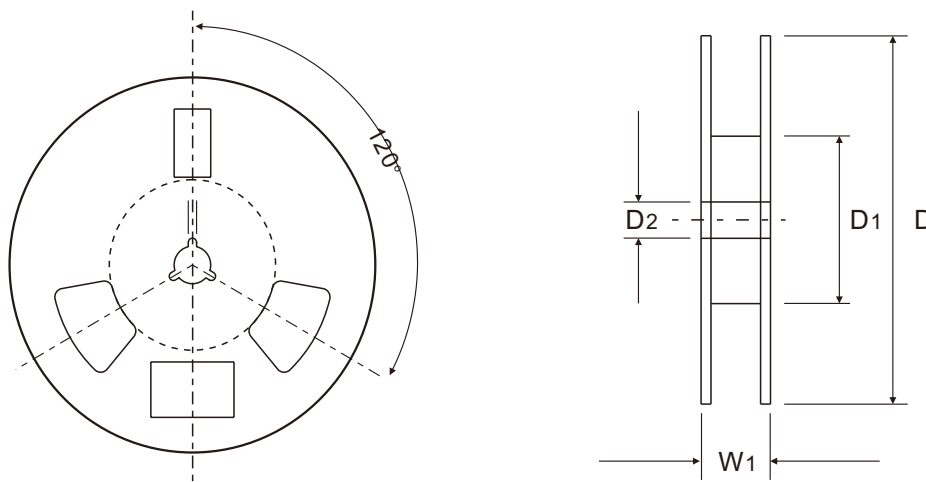
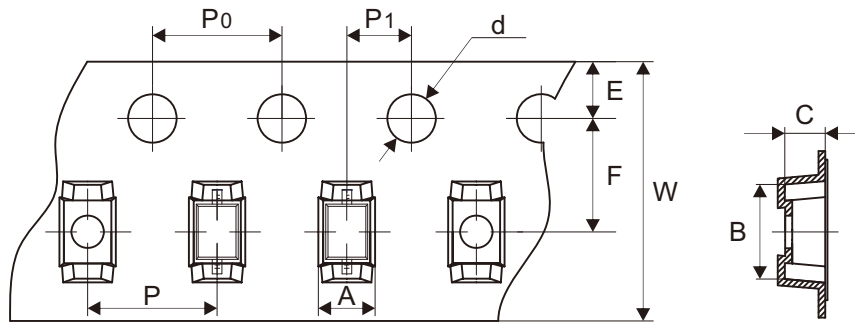

Fig.4 - Junction Capacitance vs. Reverse Voltage



Reel Taping Specification



SOD-323	SYMBOL	A	B	C	d	D	D1	D2
	(mm)	1.46 ± 0.05	2.90 ± 0.05	1.25 ± 0.05	1.50 ± 0.10	178.00 ± 2.00	54.40 ± 1.00	13.00 ± 1.00
	(inch)	0.057 ± 0.002	0.114 ± 0.002	0.049 ± 0.002	0.059 ± 0.004	7.008 ± 0.079	2.142 ± 0.039	0.512 ± 0.039

SOD-323	SYMBOL	E	F	P	P0	P1	W	W1
	(mm)	1.75 ± 0.10	3.50 ± 0.10	4.00 ± 0.10	4.00 ± 0.10	2.00 ± 0.10	8.00 + 0.30 - 0.10	12.30 ± 1.00
	(inch)	0.069 ± 0.004	0.138 ± 0.004	0.157 ± 0.004	0.157 ± 0.004	0.079 ± 0.004	0.315 + 0.012 - 0.004	0.484 ± 0.039

Company reserves the right to improve product design, functions and reliability without notice. REV:A

Marking Code

Part Number	Marking Code
CPDV3V0-HF	CC
CPDV5V0-HF	AC
CPDV8V0-HF	BC
CPDV12V0-HF	DC
CPDV15V0-HF	EC
CPDV24V0-HF	HC



xx = Product type marking code

Suggested PAD Layout

SIZE	SOD-323	
	(mm)	(inch)
A	2.85	0.112
B	1.60	0.063
C	0.85	0.033

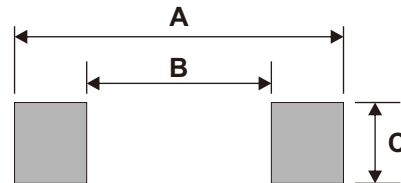

Note: 1.The pad layout is for reference purposes only.

Standard Packaging

Case Type	REEL PACK	
	REEL (pcs)	Reel Size (inch)
SOD-323	3,000	7

Looking for pricing, stock, or lifecycle information?

Click below to explore more details on WIN SOURCE:

- [View CPDV3V0-HF on WIN SOURCE](#)
- [Comchip Technology Information](#)

Optimize Your Supply Chain with WIN SOURCE Solutions

- ✓ Global Sourcing Solution
- ✓ Obsolete Management
- ✓ Cost Control Management
- ✓ Shortage Management
- ✓ Alternative Solution
- ✓ Excess Inventory Management