



# THE DATASHEET OF PB-03F-KIT





# PB-03F-Kit Specification

Version V1.0.0

Copyright©2021



## Content

1. Product Overview.....	4
1.1. Characteristic.....	5
2. Main parameters.....	6
2.1. Power supply selection.....	6
2.2. Static electricity requirements.....	7
2.3. Electrical characteristics.....	7
2.4. Bluetooth RF performance.....	7
2.5. Power consumption.....	8
3. Appearance dimensions.....	9
4. Indicator and button description.....	10
5. Pin definition.....	11
6. Schematic.....	13
7. Product related models.....	14
8. Product precautions.....	15
9. Product packaging information.....	15
10. Contact us.....	15
Disclaimer and copyright notice.....	16
Notice.....	16

# 1. Product Overview

PB-03F-Kit is a development board designed for the PB-03F module. PB-03F is a BLE module developed by Shenzhen Ai-Thinker Technology Co.,Ltd., the core processor chip PHY6252. PHY6252 is a system-on-chip (SoC) for Bluetooth 5.2 applications, designed for various applications such as the Internet of Things (IoT), mobile devices, wearable electronic devices, and smart homes. It has a high-performance, low-power 32-bit processor, with 64KB SRAM, 256KB flash memory, 96KB ROM, 256bit efuse. The chip supports a variety of low power consumption working states, which can meet the power consumption requirements of various application scenarios. Features such as adjustable radio frequency output power can achieve the best balance between communication distance, communication speed, and power consumption.

It has the following characteristics:

- Integrated radio frequency transceiver, PA, radio frequency filter, antenna switch and power management.
- Excellent communication performance and stability in various wireless environments.
- Bluetooth rate support: 125Kbps, 500Kbps, 1Mbps, 2Mbps.
- Support broadcast expansion, multi-broadcast, channel selection.

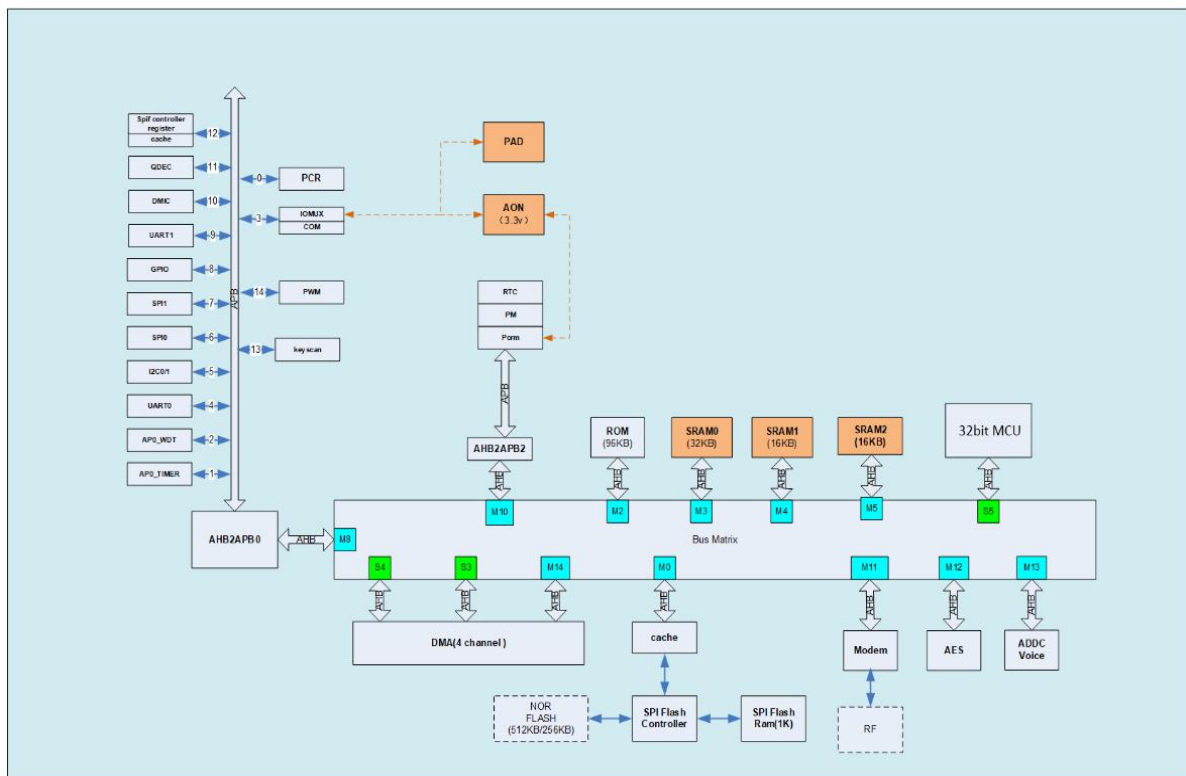

Figure 1 PHY6252 chip architecture diagram

## 1.1. Characteristic

- Support BLE5.2, rate support: 125Kbps, 500Kbps, 1Mbps, 2Mbps
- Own 64 KB SRAM, 256KB flash, 96 KB ROM, 256bit efuse
- Support UART/GPIO/ADC/PWM/I2C/SPI/PDM/DMA interface
- Support multiple sleep modes,deep sleep current is less than 1uA
- Support for serial local upgrade and remote Firmware upgrade(FOTA)
- Universal AT commands can be used easy and quickly
- Support for secondary development,with an integrated Windows development environment

## 2. Main parameters

**Table 1 Description of the main parameters**

<b>Development board Model</b>	PB-03F-Kit
<b>Suitable module</b>	PB-03F
<b>Package</b>	DIP-30 (2.54 pitch standard pin header)
<b>Antenna</b>	48.3*25.0(±0.2)mm
<b>Frequency</b>	On-board PCB antenna
<b>Operating temperature</b>	2400~2483.5MHz
<b>Storage temperature</b>	-40 °C ~ 85 °C
<b>Power supply</b>	-40 °C ~ 125 °C , < 90%RH
<b>Interface</b>	Voltage: 5V, Current>200mA
<b>IO</b>	UART/GPIO/ADC/PWM/I2C/I2S/SPI/PDM/DMA
<b>Antenna</b>	19
<b>UART rate</b>	Default 115200 bps
<b>Bluetooth</b>	BLE 5.2
<b>Security</b>	AES-128
<b>Flash</b>	256KB
<b>Power consumption</b>	Deep sleep mode (no broadcast): 7.2uA (Single module) Shutdown mode: 0.57uA (Single module) Launch mode (TX: 8dBm) : 11.5mA (Single module) The bottom plate of the development board: 4mA

### 2.1. Power supply selection

You can choose one of the following three power supply methods to power the PB-03F-Kit:

- Micro-USB interface power supply (default)
- 5V and GND pin header power supply
- 3V3 and GND pin header power supply

It is recommended to choose the first power supply mode: Micro-USB interface power supply.

## 2.2. Static electricity requirements

PB-03F-Kit development board is an electrostatic sensitive device, and special precautions must be taken when handling it.



Figure 3 ESD anti-static diagram

## 2.3. Electrical characteristics

Table 2 Electrical characteristics table

Parameters		Conditions	Min	Typical value	Max	Unit
Power supply voltage		VDD	4.5	5	5.3	V
I/O	$V_{IL}/V_{IH}$	-	-0.3/0.75V <sub>IO</sub>	-	0.25V <sub>IO</sub> /4.5	V
	$V_{OL}/V_{OH}$	-	N/0.8V <sub>IO</sub>	-	0.1V <sub>IO</sub> /N	V
	$I_{MAX}$	-	-	-	12	mA

## 2.4. Bluetooth RF performance

Table 3 BLE RF performance table

Description	Typical values			Unit
Operating frequency	2400-2483.5			MHz
<b>Output power</b>				
Mode	Min	Typical	Max	Unit
BLE 2Mbps	-20	8	10	dBm
BLE 1Mbps	-20	8	10	dBm
BLE 500Kbps	-20	8	10	dBm
BLE 125kbps	-20	8	10	dBm
<b>Receiving sensitivity</b>				
Mode	Min	Typical	Max	Unit
BLE 2Mbps	-	-93	-	dBm

BLE 1Mbps	-	-96	-	dBm
BLE 500Kbps	-	-97	-	dBm
BLE 125Kbps	-	-102	-	dBm

## 2.5. Power consumption

The following power consumption data are based on a 3.3V power supply, ambient temperature of 25°C and measured using an internal regulator.

- All measurements were completed without the SAW filter at the antenna interface.
- All emission data were measured based on the TX\_Burst\_Test&RX\_Burst\_Test mode.

**Table 4 Power consumption table**

Mode	Min	Average value	Max	Unit
TX_Burst_Test Power output 8dBm	-	11.5	-	mA
TX_Burst_Test Power output 5dBm	-	9	-	mA
TX_Burst_Test Power output 0dBm	-	8	-	mA
RX_Burst_Test	-	9.4	-	mA
Deep Sleep(With broadcast,1 second interval)	-	50.58	-	uA
Deep Sleep(With broadcast, 2 second interval)	-	28.25	-	uA
Deep Sleep(Without broadcast)	-	7.2	-	uA
Power Off	-	0.57	-	uA

### 3. Appearance dimensions

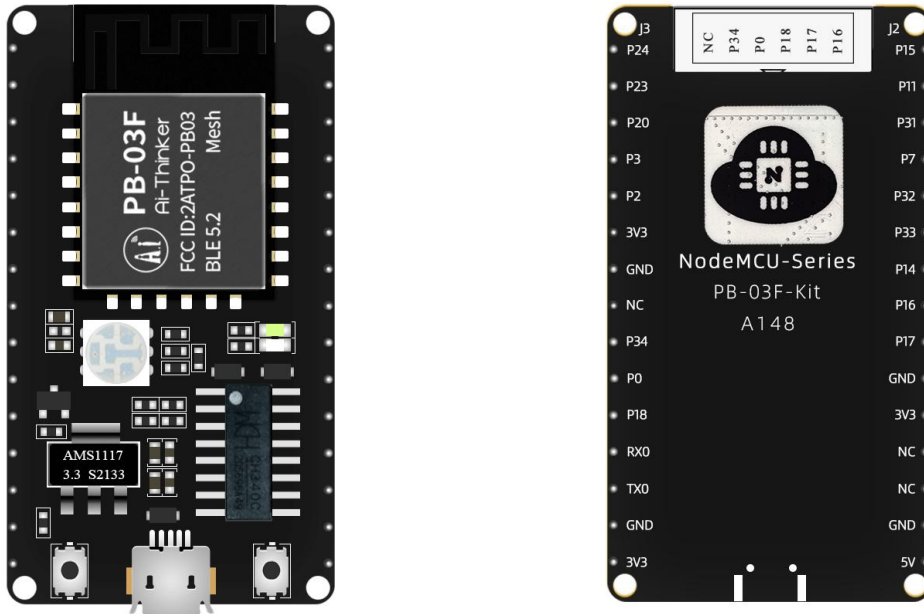

Figure 4 PB-03F-Kit appearance (Pictures and silkscreen are for reference only) )

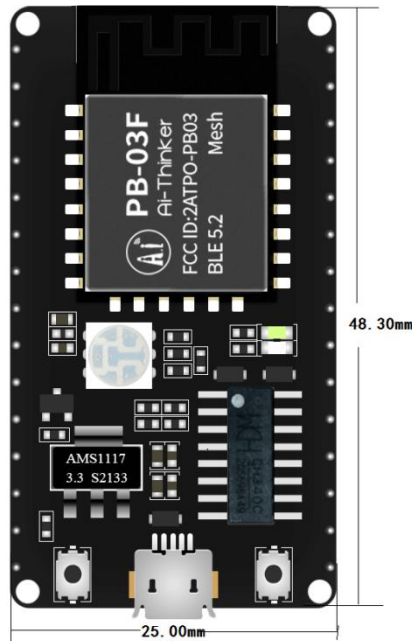

Figure 5 Development board size drawing

## 4. Indicator and button description

PB-03F-Kit has 3 indicator lights, namely: RGB light, yellow light and white light. Two buttons are brought out, namely: RST button (left) and Restore button (right), as shown in the figure below:

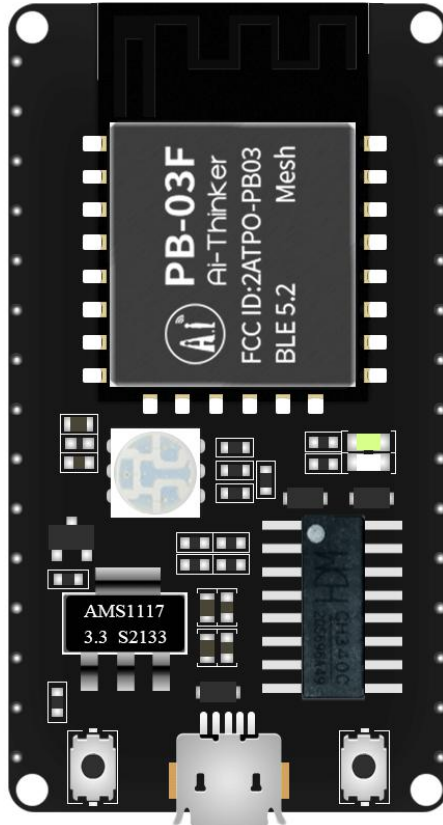

Figure 6 PB-03F-Kit indicator and button location

Table 5 Indicator status and key function table

Indicator light or button	LED status or button function	Remark
RGB light	Red light (P7)	/
	Green light (P11)	
	Blue light (P18)	
White light	Cool light (P34)	/
Yellow light	Warm light (P0)	/
Restore button	Restore factory settings button (P15)	/
RST button	Restart button	/

## 5. Pin definition

PB-03F-Kit has a total of 30 pins. As shown in the pin diagram, the pin function definition table is the interface definition.

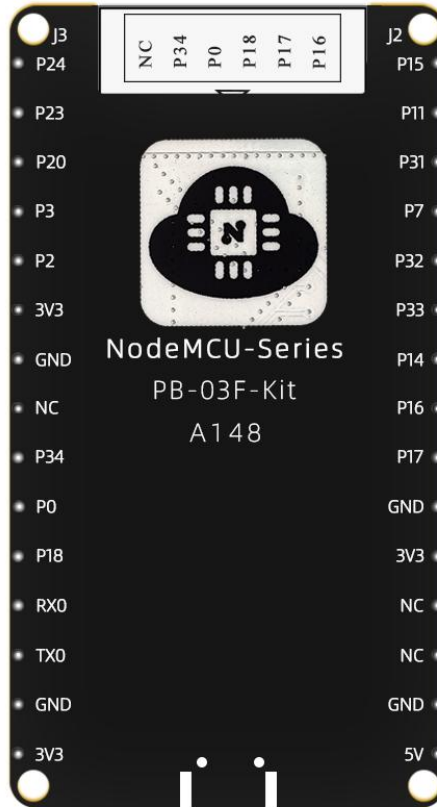

Figure 7 Schematic diagram of development board pins (bottom view)

Table 6 Pin function definition table

No.	Name	Function
1	P13	GPIO13
2	P11	GPIO11
3	P31	GPIO11
4	P7	GPIO7
5	P32	GPIO32
6	P33	GPIO33
7	P14	GPIO14/ADC input 3
8	P16	GPIO16
9	P17	GPIO17

10	GND	Ground Pin
11	3V3	3.3V power supply
12	NC	Empty
13	NC	Empty
14	GND	Ground Pin
15	5V	5V power supply
16	3V3	3.3V power supply
17	GND	Ground Pin
18	TX0	TXD/GPIO9
19	RX0	RXD/GPIO10
20	P18	GPIO18
21	P0	GPIO0
22	P34	GPIO34
23	NC	Empty
24	GND	Ground Pin
25	3V3	3.3V power supply
26	P2	GPIO2/SWD debug data inout
27	P3	GPIO3/SWD debug clock
28	P20	GPIO20/ADC input 9/PGA positive input
29	P23	GPIO23/ADC input 1/micbias reference
30	P24	GPIO24

## 6. Schematic

PB-03F-Kit schematic.

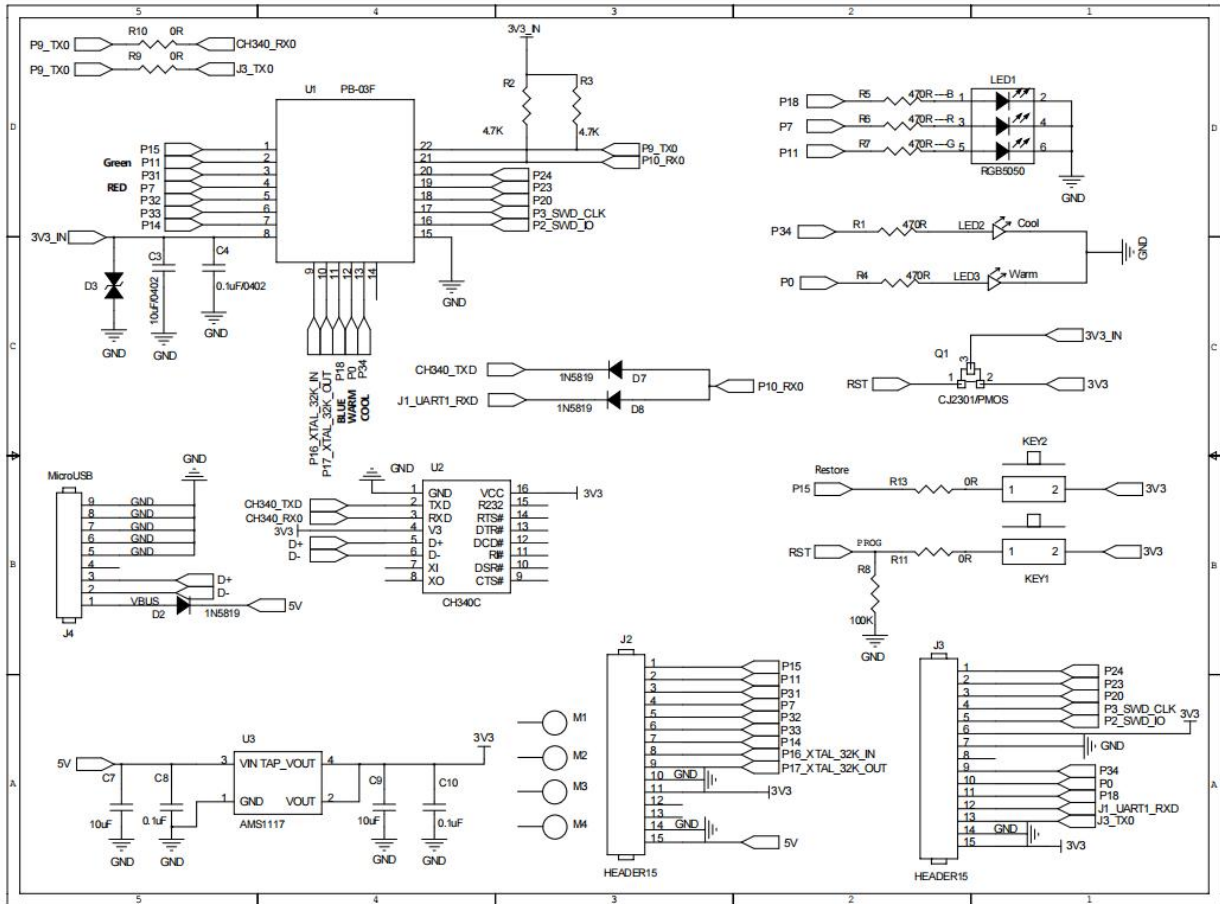

Figure 8 Schematic diagram of the development board

## 7. Product related models

**Table 7 Product related model list**

Module	Power supply	Package	Size	Antenna
PB-03	3.3V, I>200mA	SMD-52	16.6*13.2*2.8(±0.2)mm	On-board PCB
PB-03F	3.3V, I>200mA	SMD-22	24.0*16.0*3.1(±0.2)mm	On-board PCB
PB-03M	3.3V, I>200mA	DIP-18	18.0*18.0*2.8(±0.2)mm	On-board PCB
PB-03-Kit	5V, I>200mA	DIP-30	48.30*25.00(±0.2)mm	On-board PCB
PB-03F-Kit	5V, I>200mA	DIP-30	48.30*25.00(±0.2)mm	On-board PCB
PB-03M-Kit	5V, I>200mA	DIP-20	35.30*28.42(±0.2)mm	On-board PCB
Product related information: <a href="https://docs.ai-thinker.com">https://docs.ai-thinker.com</a>				

## 8. Product precautions

Since the chip used by the PB-03F module does not have an RST pin, the reset button of the PB-03F-Kit is directly powered off and then powered on to reset. When downloading and burning firmware, you need to use the RST pin to power on and reset.

## 9. Product packaging information

**Table 8 Packaging Information Table**

Packing list	Packing method	Quantity per pack (Electrostatic bag)	Quantity per pack (Sealed bag)
PB-03F-Kit	Foam + static bag	1pcs	20pcs

## 10. Contact us

[Ai-Thinker official website](#)

[Office forum](#)

[Develop DOCS](#)

[LinkedIn](#)

[Tmall shop](#)

[Taobao shop](#)

[Alibaba shop](#)

Technic support email: [support@aithinker.com](mailto:support@aithinker.com)

Domestic business cooperation: [sales@aithinker.com](mailto:sales@aithinker.com)

Overseas business cooperation: [overseas@aithinker.com](mailto:overseas@aithinker.com)

Company Address: Room 403,408-410, Block C, Huafeng Smart Innovation Port, Gushu 2nd Road, Xixiang, Baoan District, Shenzhen.

Tel: 0755-29162996



WeChat mini program



WeChat official account

## Disclaimer and copyright notice

The information in this article,including the URL address for reference,is subject to change without notice.

The document is provided "as is" without any guarantee responsibility,including any guarantee for merchantability,suitability for a specific purpose,or non-infringement,and any guarantee mentioned elsewhere in any proposal,specification or sample.This document does not bear any responsibility,including the responsibility for infringement of any patent rights arising from the use of the information in this document.This document does not grant any license for the use of intellectual property rights in estoppel or other ways,whether express or implied.

The test data obtained in the article are all obtained from Ai-Thinker's laboratory tests,and the actual results may vary slightly.

All brand names,trademarks and registered trademarks mentioned in this article are the property of their respective owners,and it is hereby declared.

The final interpretation right belongs to Shenzhen Ai-Thinker Technology Co.,Ltd.

## Notice



Due to product version upgrades or other reasons,the contents of this manual may be changed.

Shenzhen Ai-Thinker Technology Co.,Ltd.reserves the right to modify the contents of this manual without any notice or prompt.







This manual is only used as a guide.Shenzhen Ai-Thinker Technology Co.,Ltd.makes every effort to provide accurate information in this manual.However,Shenzhen Ai-Thinker Technology Co.,Ltd.does not guarantee that the contents of the manual are completely free of errors.All statements and information in this manual And the suggestion does not constitute any express or implied guarantee.

## Looking for pricing, stock, or lifecycle information?

Click below to explore more details on WIN SOURCE:

-  [View PB-03F-KIT on WIN SOURCE](#)
-  [Ai-Thinker Information](#)

## Optimize Your Supply Chain with WIN SOURCE Solutions

-  Global Sourcing Solution
-  Obsolete Management
-  Cost Control Management
-  Shortage Management
-  Alternative Solution
-  Excess Inventory Management