



**THE DATASHEET OF
PE1605C2A_R1_00001**





PE1605C2A

Ultra Low Capacitance ESD Protection

Voltage

5 V

Features

- IEC61000-4-2(ESD) : ±20kV Air, ±15kV Contact
- IEC61000-4-4(EFT) : 40A(5/50ns)
- IEC61000-4-5(Lightning) : 4A(8/20μS)
- Low leakage current, maximum of 50nA at rated voltage
- Ultra low capacitance
- Low clamping voltage
- Lead free in compliance with EU RoHS 2.0
- Green molding compound as per IEC 61249 standard

Mechanical Data

- Case: Molded plastic, SOT-23

Applications

- USB 3.0 Data Line Protection
- Mobile Phones and accessories
- Hand held portable
- Digital Cameras
- Computer Interfaces Protection
- Serial and Parallel Ports Protection
- Control Signal Lines Protection

SOT-23

Unit: inch(mm)

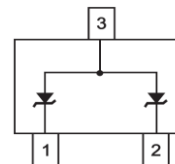
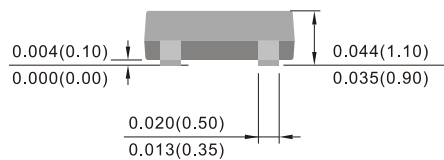
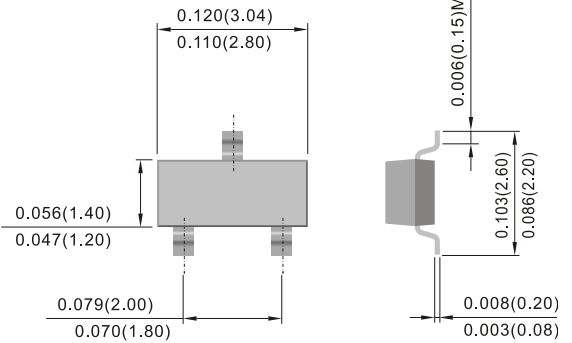

Maximum Ratings

PARAMETER	SYMBOL	VALUE	UNITS
ESD IEC61000-4-2(Air)	V_{ESD}	±20	kV
ESD IEC61000-4-2(Contact)		±15	
Operating Junction Temperature Range	T_J	-55 to +150	°C
Storage Temperature Range	T_{STG}	-55 to +150	°C



PE1605C2A

Electrical Characteristics

PARAMETER	SYMBOL	TEST CONDITION	MIN.	TYP.	MAX.	UNITS
Reverse Stand-Off Voltage ^(Note 1)	V_{RWM}	-	-	-	5	V
Reverse Breakdown Voltage	V_{BR}	$I_{BR}=1\text{mA}$	5.5	-	-	V
Reverse Leakage Current	I_R	$V_R=5.0\text{V}$	-	-	50	nA
Clamping Voltage	V_{CL}	$I_{PP}=1\text{A}$, $t_p=8/20\mu\text{s}$, any I/O pins to GND	-	-	10	V
		$I_{PP}=4\text{A}$, $t_p=8/20\mu\text{s}$, any I/O pins to GND	-	-	15	V
Clamping Voltage TLP ^(Note 2)	V_{CL}	$I_{PP}=8\text{A}$, $t_p=100\text{ns}$, any I/O pins to GND	-	16	-	V
		$I_{PP}=16\text{A}$, $t_p=100\text{ns}$, any I/O pins to GND	-	23.5	-	V
Dynamic Resistance	R_{DYN}	$t_p=100\text{ns}$	-	0.94	-	Ω
Off State Junction Capacitance	C_J	2.5Vdc Bias $f=1\text{MHz}$, any I/O pins to GND	-	0.3	0.35	pF
		2.5Vdc Bias $f=1\text{MHz}$, Between any I/O pins	-	0.2	-	pF

Note :

1. A transient suppressor is selected according to the working peak reverse voltage (V_{RWM}), which should be equal to or greater than the DC or continuous peak operation voltage level.
2. Testing using Transmission Line Pulse (TLP) conditions: $Z_0 = 50\Omega$, $t_p = 100\text{ ns}$.



PE1605C2A

TYPICAL CHARACTERISTIC CURVES

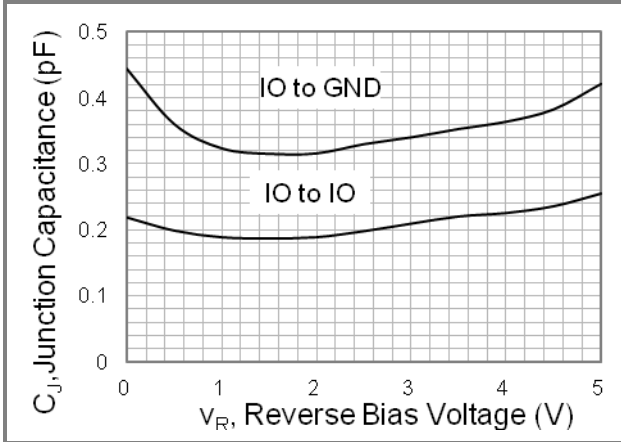

Fig.1 Typical Junction Capacitance

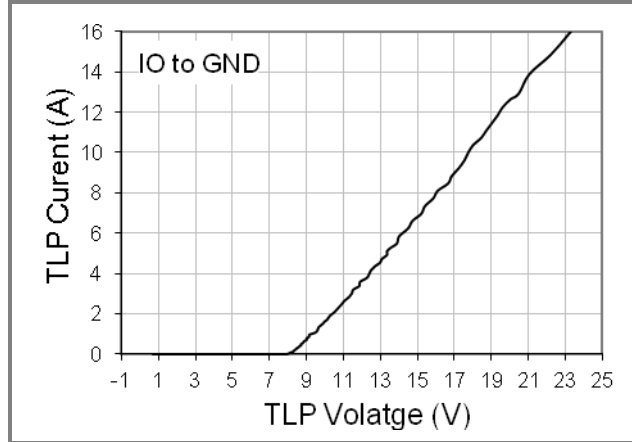

Fig.2 Transmission Line Pulsing (TLP) Measurement

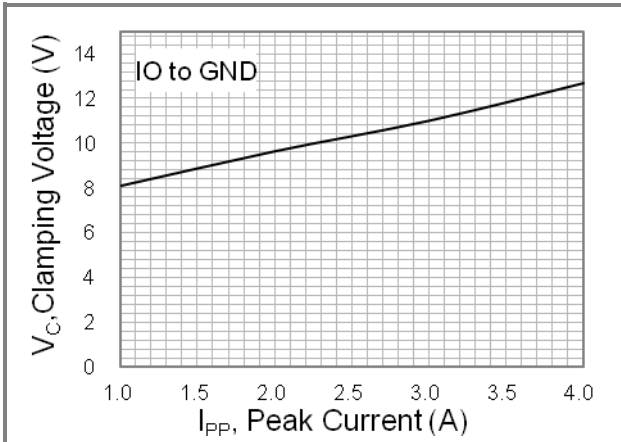

Fig.3 Typical Peak Clamping Voltage(8/20 μ s)

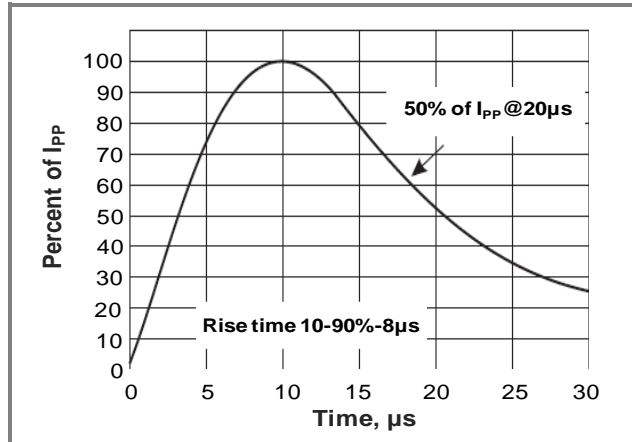

Fig.4 8/20 μ s Pulse Waveform



PE1605C2A

Part No Packing Code Version

Part No Packing Code	Package Type	Packing Type	Marking	Version
PE1605C2A_R1_00001	SOT-23	3K pcs / 7" reel	KCC	Halogen free
PE1605C2A_R2_00001	SOT-23	12K pcs / 13" reel	KCC	Halogen free

Mounting Pad Layout

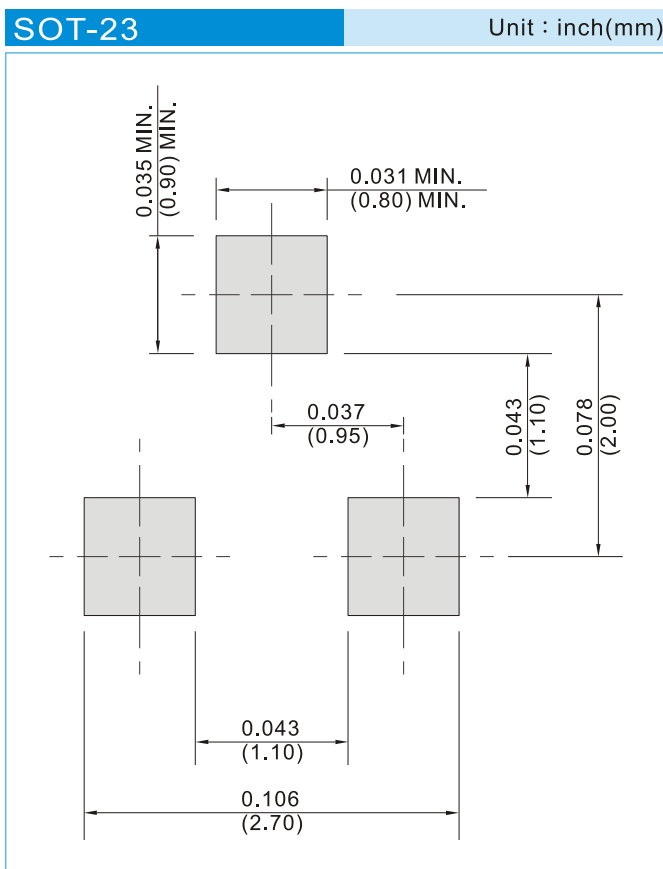



PE1605C2A

Disclaimer

- Reproducing and modifying information of the document is prohibited without permission from Panjit International Inc..
- Panjit International Inc. reserves the rights to make changes of the content herein the document anytime without notification. Please refer to our website for the latest document.
- Panjit International Inc. disclaims any and all liability arising out of the application or use of any product including damages incidentally and consequentially occurred.
- Panjit International Inc. does not assume any and all implied warranties, including warranties of fitness for particular purpose, non-infringement and merchantability.
- Applications shown on the herein document are examples of standard use and operation. Customers are responsible in comprehending the suitable use in particular applications. Panjit International Inc. makes no representation or warranty that such applications will be suitable for the specified use without further testing or modification.
- The products shown herein are not designed and authorized for equipments requiring high level of reliability or relating to human life and for any applications concerning life-saving or life-sustaining, such as medical instruments, transportation equipment, aerospace machinery et cetera. Customers using or selling these products for use in such applications do so at their own risk and agree to fully indemnify Panjit International Inc. for any damages resulting from such improper use or sale.
- Since Panjit uses lot number as the tracking base, please provide the lot number for tracking when complaining.

Looking for pricing, stock, or lifecycle information?

Click below to explore more details on WIN SOURCE:

 [View PE1605C2A_R1_00001 on WIN SOURCE](#)

 [Panjit Information](#)

Optimize Your Supply Chain with WIN SOURCE Solutions

-  Global Sourcing Solution
-  Obsolete Management
-  Cost Control Management
-  Shortage Management
-  Alternative Solution
-  Excess Inventory Management