



**THE DATASHEET OF
800AWSP9M2QE**





SERIES 800A SWITCHES

PUSHBUTTON SWITCHES - SUB-MINIATURE

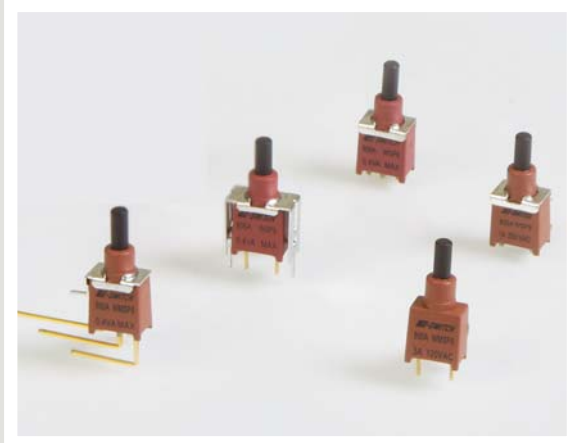

SPECIFICATIONS

Contact Rating:	3A @ 120 VAC or 28 VDC 1A @ 250 VAC
Life Expectancy:	50,000 cycles typical
Contact Resistance:	10mΩ 1 max. typical @ 2-4 VDC 100mA for both silver and gold plated contacts
Insulation Resistance:	1,000MΩ 1min.
Dielectric Strength:	1,000 V rms @ sea level
Actuation Force:	200 ± 50 gf
Operating Temperature:	-30°C to +85°C

MATERIALS

Case:	Diallyl Phthalate (DAP)
Plunger:	Glass filled nylon or glass filled polyester
Bushing:	Diallyl Phthalate (DAP)
Housing:	Stainless steel
Contacts:	Silver or Gold plated copper alloy

FEATURES & BENEFITS

- ▶ Subminiature design
- ▶ Butt contact design
- ▶ IP-67 sealed option

APPLICATIONS/MARKETS

- ▶ Telecommunications
- ▶ Networking
- ▶ Computers/servers
- ▶ Performance audio
- ▶ Instrumentation
- ▶ Low power on/off designs
- ▶ External hard drives and modems



HOW TO ORDER

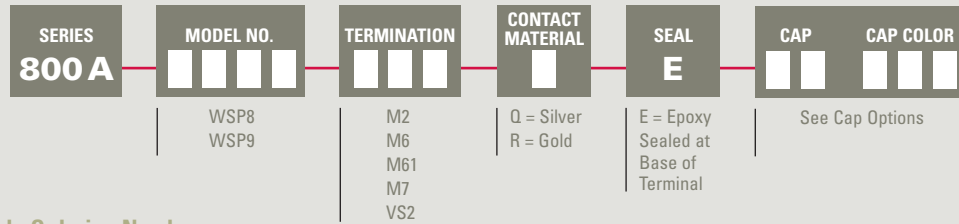

Example Ordering Number
800A-WSP9-M7-R-E

Specifications subject to change without notice 1.8.2018

SPDT

WSP8



Model No.	Type	
WSP8	ON	(ON)
WSP9	OFF	(ON)

() = Momentary

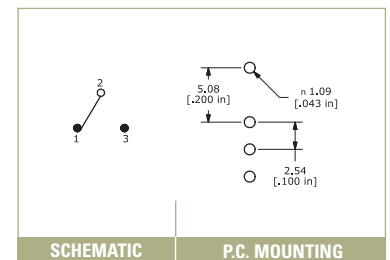
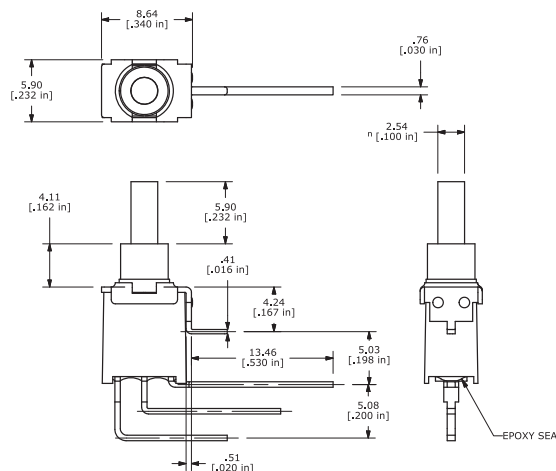

SERIES 800A SWITCHES

PUSHBUTTON SWITCHES - SUB-MINIATURE

TACT SWITCHES

NAVIGATION SWITCHES

PUSHBUTTON SWITCHES

TOGGLE SWITCHES

ROCKER SWITCHES

SLIDE SWITCHES

SNAP-ACTION SWITCHES

DIP SWITCHES

KEYLOCK SWITCHES

ROTARY SWITCHES

DETECTOR SWITCHES

CAP OPTIONS

SPST

WSP9

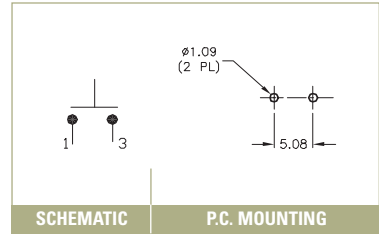
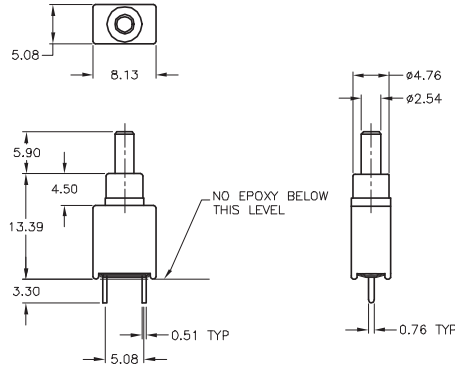

M2

SPST

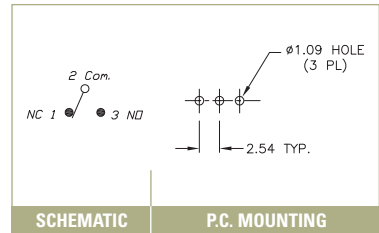
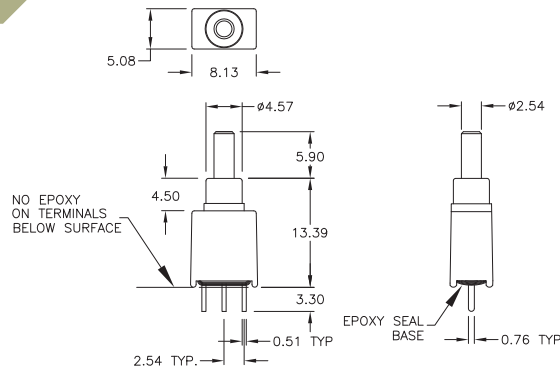

M6

SPST

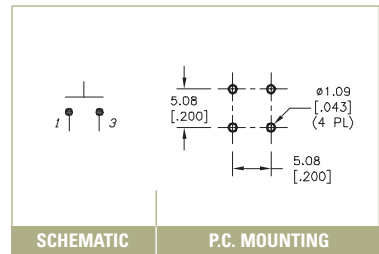
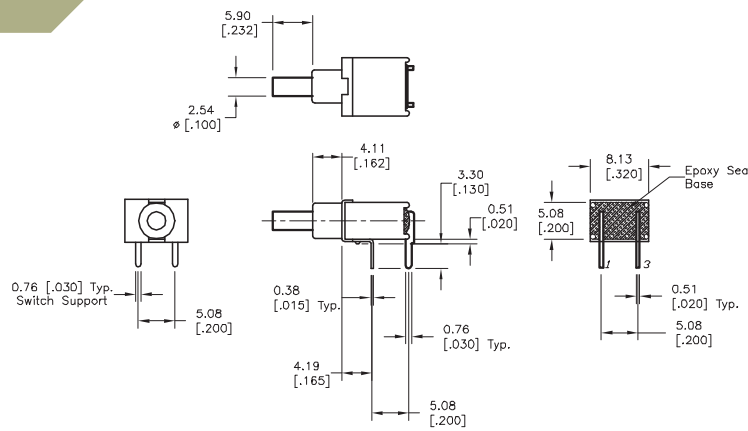

M61

SPST

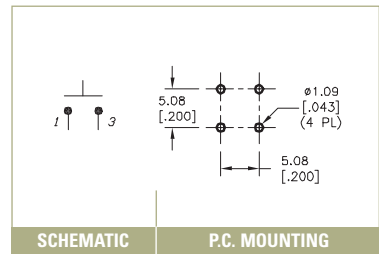
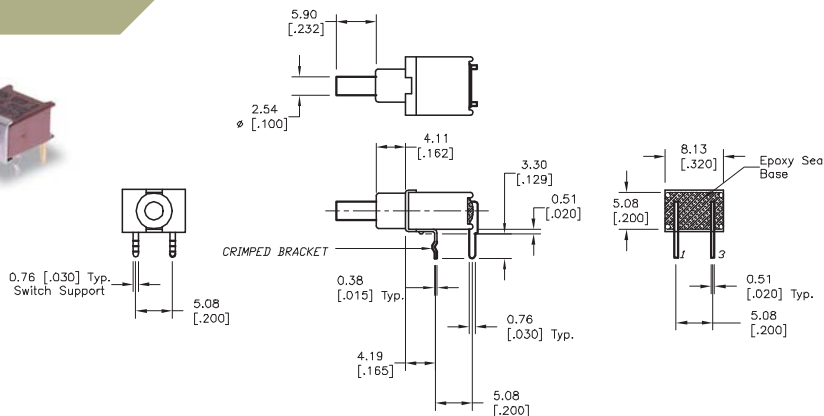

M7

SPST

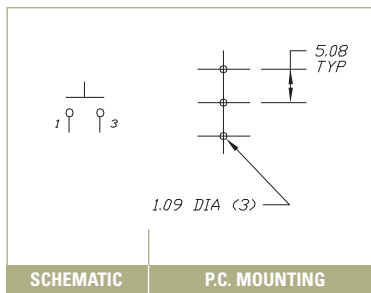
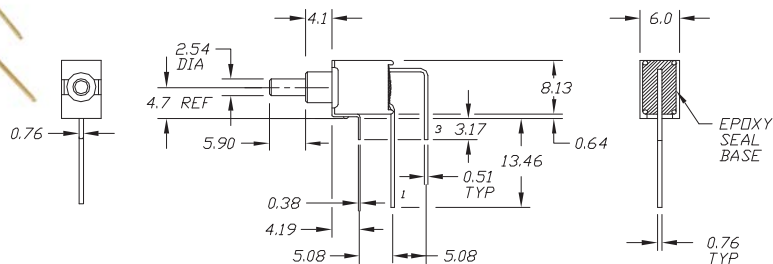
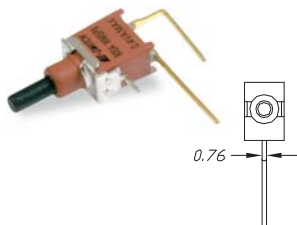

VS2

SPST

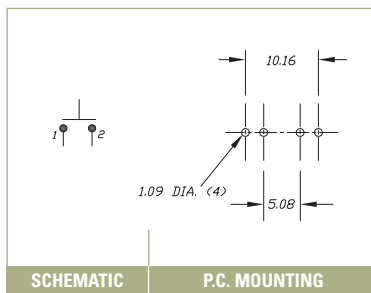
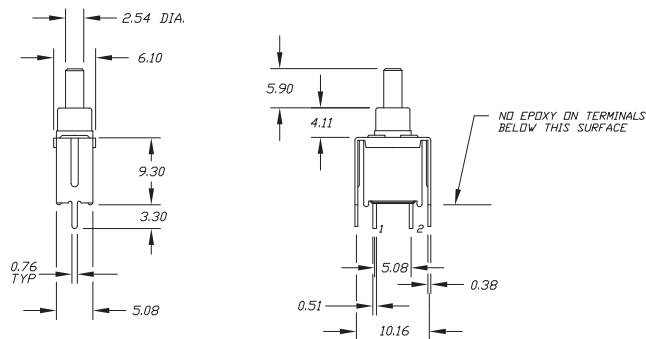

CONTACT MATERIAL OPTIONS

Q



Fixed Terminal:	Silver plated copper alloy
Moving Contact:	Silver plated copper alloy
Rating:	3A @ 120 VAC or 28 VDC 1A @ 250 VAC

R





Fixed Terminal:	Copper alloy with gold plate over nickel plate
Moving Contact:	Copper alloy with gold plate over nickel plate
Rating:	0.4 VA max. @ 20 VAC or DC max.

Looking for pricing, stock, or lifecycle information?

Click below to explore more details on WIN SOURCE:

-  [View 800AWSP9M2QE](#) on WIN SOURCE
-  [E-Switch](#) Information

Optimize Your Supply Chain with WIN SOURCE Solutions

-  Global Sourcing Solution
-  Obsolete Management
-  Cost Control Management
-  Shortage Management
-  Alternative Solution
-  Excess Inventory Management