



**THE DATASHEET OF
RM103772BCB**



RM Series Subminiature Rotary Switches



Features/Benefits

- Subminiature design saves space
- Screwdriver slot or extended shaft
- Positive detent
- RoHS compliant

Typical Applications

- Audio & visual equipment
- Consumer electronics
- Telecom equipment

Specifications

CONTACT RATING: 0.5A 24 V DC; 0.2A 48 V DC
 OPERATING LIFE: 2,000 cycles
 INSULATION RESISTANCE: 100 M Ω min. 500 V DC
 DIELECTRIC STRENGTH: 500 V AC for 1 minute
 OPERATING FORCE: 270 \pm 100 gf cm
 OPERATING TEMPERATURE: -40°C to 85°C

Materials

COVER: PA66
 BASE: PA6T
 ACTUATOR: PA66
 CONTACTS & TERMINALS: Brass with gold plate over nickel plate
 SPRING: Brass

NOTE: Specifications and materials listed above are for switches with standard options.
 For information on specific and custom switches, consult Customer Service Center.



K

Rotary

Build-A-Switch

To order, simply select desired option from each category and place in the appropriate box. Available options are shown and described on pages K-30 thru K-32. For additional options not shown in catalog, consult Customer Service Center.

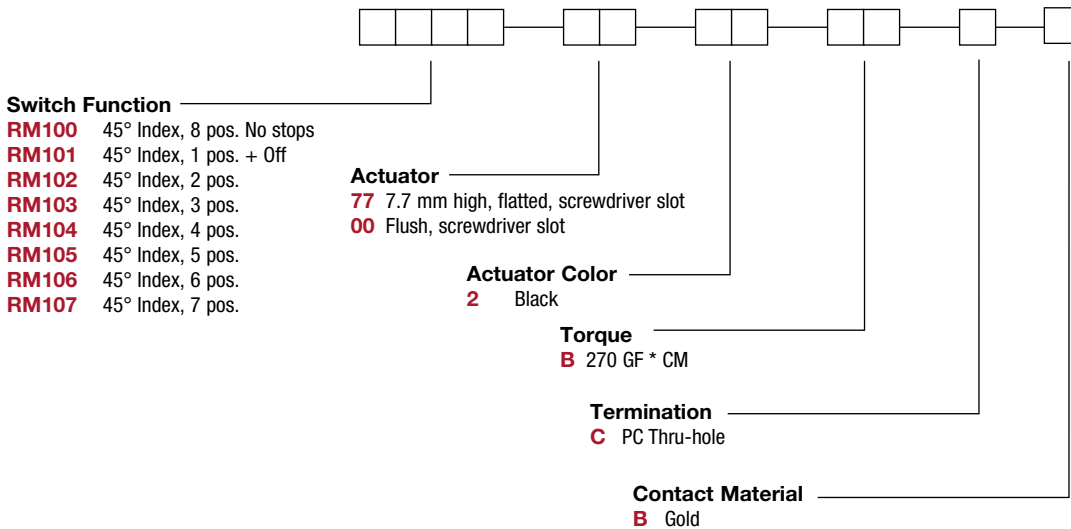

RM Series Subminiature Rotary Switches

77 7.7 MM HIGH, FLATTED, SCREWDRIVER SLOT

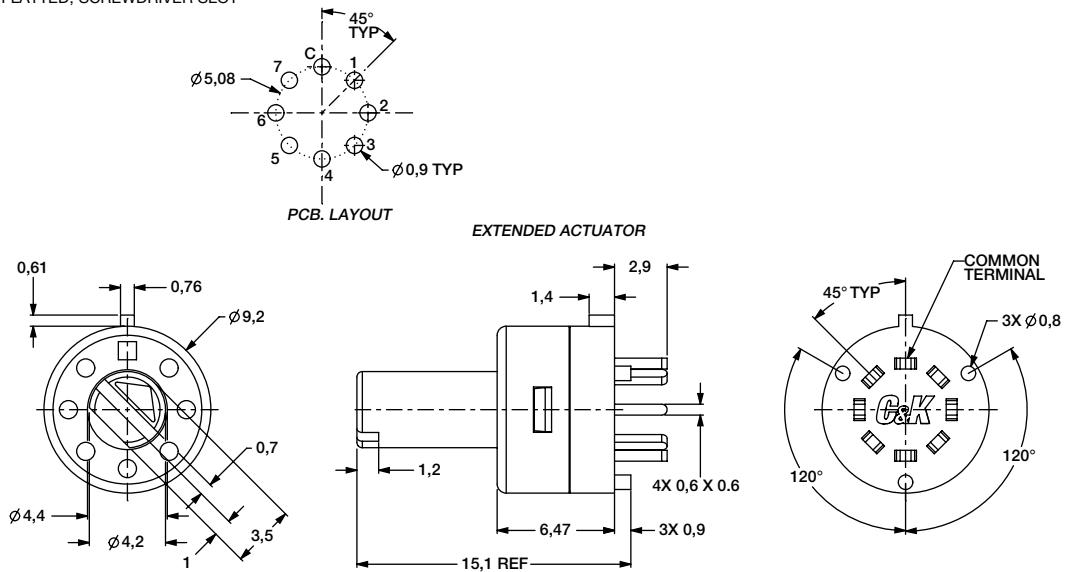

00 FLUSH, SCREWDRIVER SLOT

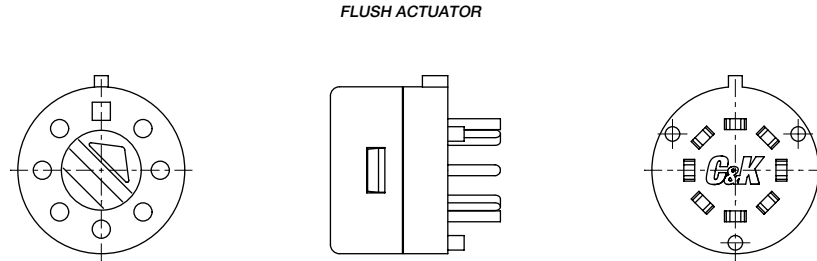

ELECTRICAL SCHEMATIC - RM SERIES SWITCHES

SWITCH FUNCTION	TRAVEL POSITION 0°	TRAVEL POSITION 45°	TRAVEL POSITION 90°	TRAVEL POSITION 135°	TRAVEL POSITION 180°	TRAVEL POSITION 225°	TRAVEL POSITION 270°	TRAVEL POSITION 315°
RM100	C-C(OFF)	C-1	C-2	C-3	C-4	C-5	C-6	C-7
RM101	C-C(OFF)	X	X	X	X	X	X	C-7
RM102	X	C-1	C-2	X	X	X	X	X
RM103	X	C-1	C-2	C-3	X	X	X	X
RM104	X	C-1	C-2	C-3	C-4	X	X	X
RM105	X	C-1	C-2	C-3	C-4	C-5	X	X
RM106	X	C-1	C-2	C-3	C-4	C-5	C-6	X
RM107	X	C-1	C-2	C-3	C-4	C-5	C-6	C-7

TERMINAL ID NUMBERS ARE SHOWN FOR REFERENCE ONLY AND ARE NOT MARKED ON BOTTOM OF THE SWITCH

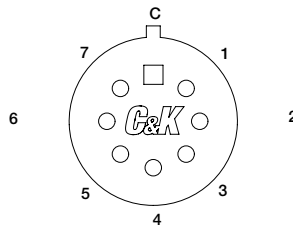

EXTERIOR KEY TAB SHOWN IDENTIFIES "C" (COMMON TERMINAL)

RM Series Subminiature Rotary Switches

KNOBS

297F02000

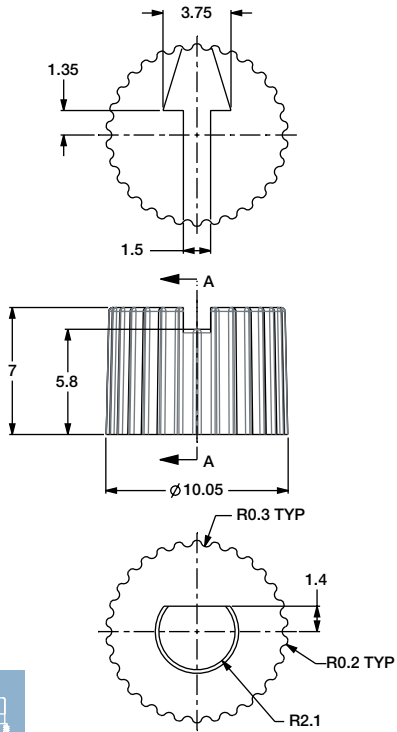

296F02000

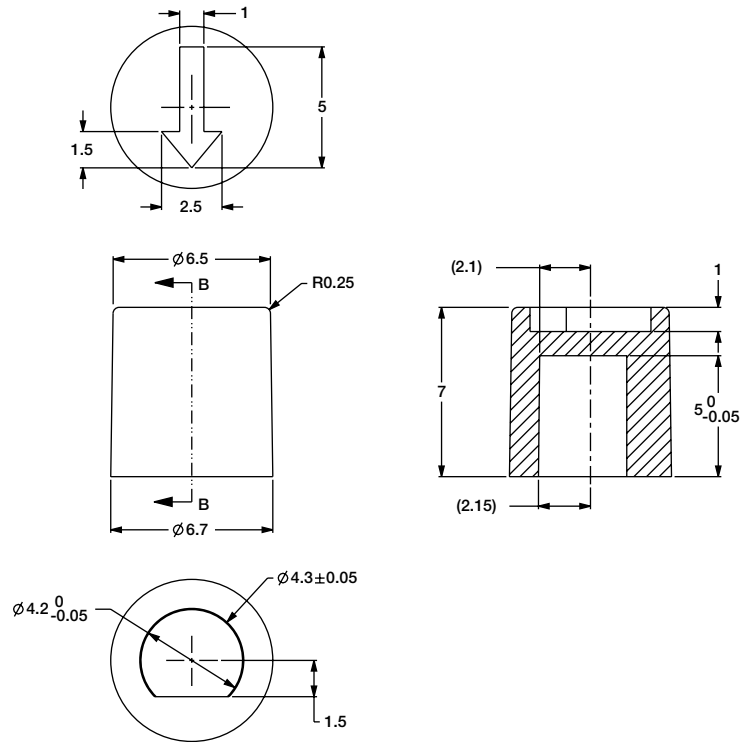

K

Rotary

Looking for pricing, stock, or lifecycle information?

Click below to explore more details on WIN SOURCE:

- ⊖ [View RM103772BCB on WIN SOURCE](#)
- ⊖ [C&K Components Information](#)

Optimize Your Supply Chain with WIN SOURCE Solutions

- ✓ Global Sourcing Solution
- ✓ Obsolete Management
- ✓ Cost Control Management
- ✓ Shortage Management
- ✓ Alternative Solution
- ✓ Excess Inventory Management