



THE DATASHEET OF
0297005.U





MINI® Blade Fuses



MINI® Shunt

MINI® Blade Fuses Rated 32V

The MINI® Fuse is the standard for vehicle circuit protection. Its miniature design meets the need for more circuits to be protected while utilizing less space, and its ability to cope with high temperatures in adverse environments makes the MINI® Fuse of recommended choice for protection.

Specifications

	MINI (Silver Plated)	MINI Sn (Tin Plated)
Voltage Rating:	32 VDC	32 VDC
Interrupting Rating:	1000A @ 32 VDC	1000A @ 32 VDC
*Recommended Environmental Temperature:	-40°C to +125°C	-40°C to +125°C
Terminals Material:	Silver plated zinc alloy PA66	Tin plated zinc alloy PA66
Housing Material:	(U.L. 94 Flammability rating – V2) Thermoplastic	(U.L. 94 Flammability rating – V2) -
MINI® Shunt Housing Material:	(U.L. 94 Flammability rating – V0)	-
Net Weight Per Fuse:	0.57±5% gr	0.57±5% gr
Complies with:	SAE J2077, ISO 8820-3, UL 248 Special Purpose Fuses	SAE J2077, ISO 8820-3 not UL recognized



*Tin plating's temperature limit is ≈130°C. Silver plating allows up to 150°C at the terminal interface.

Time-Current Characteristic Curves

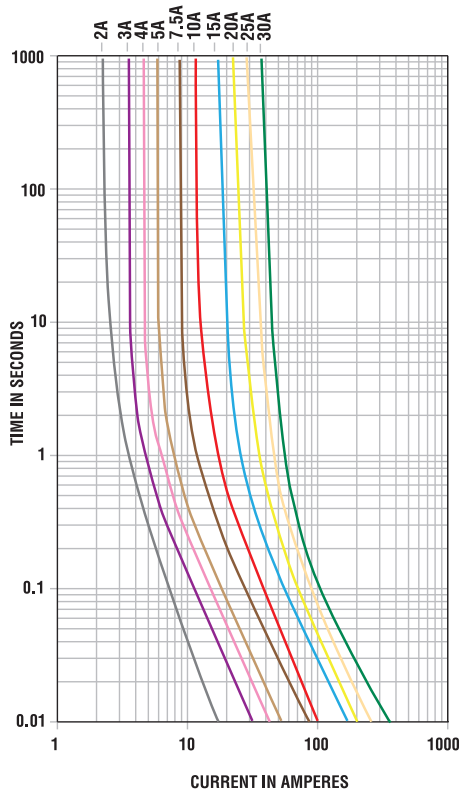

Ordering Information

Part Number	Rating	Package Size
0297xxx.WXNV	2 - 30 & SHUNT	3000
0297xxx.U	2 - 30	500
0297xxx.H	2 - 30	100
0297xxx.L	2 - 30	50
MINI® Sn Fuse		
0297xxx.WXT	2 - 30	3000

Time-Current Characteristics

% of Rating	Opening Time Min / Max (s)
110	360,000 / ∞
135	0.75 / 600
200	0.15 / 5
350	0.08 / 0.5
600	0.03 / 0.1

Ratings

Part Number	Current Rating (A)	Housing Material Color	Test Cable Size (mm ²)	Typ. Voltage Drop (mV)	Typ. Cold Resistance (mΩ)	Typ. I ² t (A ² s)
0297002._	2	Grey	0.5	171	55.60	2.8
0297003._	3	Purple	0.5	153	33.75	9.4
0297004._	4	Pink	0.5	121	23.48	17
0297005._	5	Brown	0.5	129	17.75	25
029707.5_	7.5	Dark Brown	0.75	135	10.85	68
0297010._	10	Red	1	108	7.42	93
0297015._	15	Blue	1.5	98	4.58	270
0297020._	20	Yellow	2.5	96	3.21	380
0297025._	25	Light Orange	2.5	86	2.36	625
0297030._	30	Green	4	87	1.85	1,100
0297900._	SHUNT	Light Orange	-	-	-	-

The typical I²t is an average value calculated from the breaking capacity tests by using the melting time before the arcing occurs.

MINI® Blade Fuses Rated 32V

Dimensions

Dimensions in mm for reference only. See outline drawing for dimensions and tolerances.

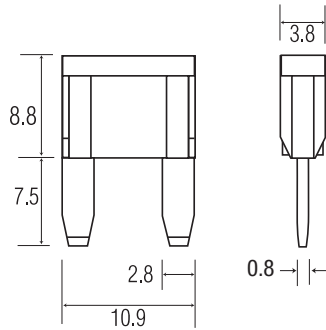

Temperature Table

	max. allowed current load [A] at ambient temperature (typical derating)							
	-40°C	-20°C	0°C	20°C	40°C	60°C	80°C	100°C
2A	2.0	2.0	2.0	1.9	1.7	1.6	1.4	1.3
3A	3.0	2.8	2.7	2.5	2.4	2.2	2.0	1.8
4A	4.0	3.8	3.6	3.4	3.2	2.9	2.7	2.4
5A	5.0	4.8	4.5	4.3	4.0	3.7	3.4	3.0
7.5A	7.5	7.1	6.8	6.4	6.0	5.5	5.1	4.5
10A	10	10	9.8	9.2	8.6	8.0	7.3	6.5
15A	15	15	14	13	12	12	11	9.0
20A	20	19	18	17	16	15	14	12
25A	25	24	22	21	20	18	17	15
30A	30	29	27	26	24	22	20	18

MINI SHUNT Maximum Continuous Load at 85°C: 20A

Typical Derating of Fuse Melting Element

Temperature Security Margin is 20%

Please contact Littelfuse® for Details Regarding Derating Test Set-Up.

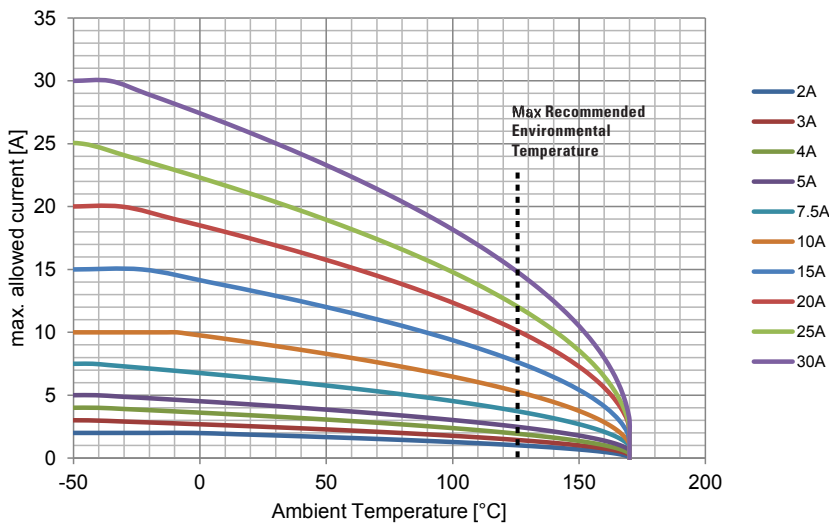

Derating curves may change depending on the final condition of the application (terminals characteristics, wire size etc.). Please ask Littelfuse® for more information.

REV11042021

Littelfuse® products are not designed for, and shall not be used for, any purpose (including, without limitation, automotive, military, aerospace, medical, life-saving, life-sustaining or nuclear facility applications, devices intended for surgical implant into the body, or any other application in which the failure or lack of desired operation of the product may result in personal injury, death, or property damage) other than those expressly set forth in applicable Littelfuse® product documentation. Warranties granted by Littelfuse® shall be deemed void for products used for any purpose not expressly set forth in applicable Littelfuse® documentation. Littelfuse® shall not be liable for any claims or damages arising out of products used in applications not expressly intended by Littelfuse® as set forth in applicable Littelfuse® documentation. The sale and use of Littelfuse® products is subject to Littelfuse Terms and Conditions of Sale, unless otherwise agreed by Littelfuse®.

Looking for pricing, stock, or lifecycle information?

Click below to explore more details on WIN SOURCE:

 [View 0297005.U on WIN SOURCE](#)

 [Littelfuse Inc. Information](#)

Optimize Your Supply Chain with WIN SOURCE Solutions

-  Global Sourcing Solution
-  Obsolete Management
-  Cost Control Management
-  Shortage Management
-  Alternative Solution
-  Excess Inventory Management