



**THE DATASHEET OF  
R6200240XX00**



Powerex, Inc., 200 Hillis Street, Youngwood, Pennsylvania 15697-1800 (412) 925-7272  
 Powerex, Europe, S.A. 428 Avenue G. Durand, BP107, 72003 Le Mans, France (43) 41.14.14

### General Purpose Rectifier

300-500 Amperes  
 2400 Volts

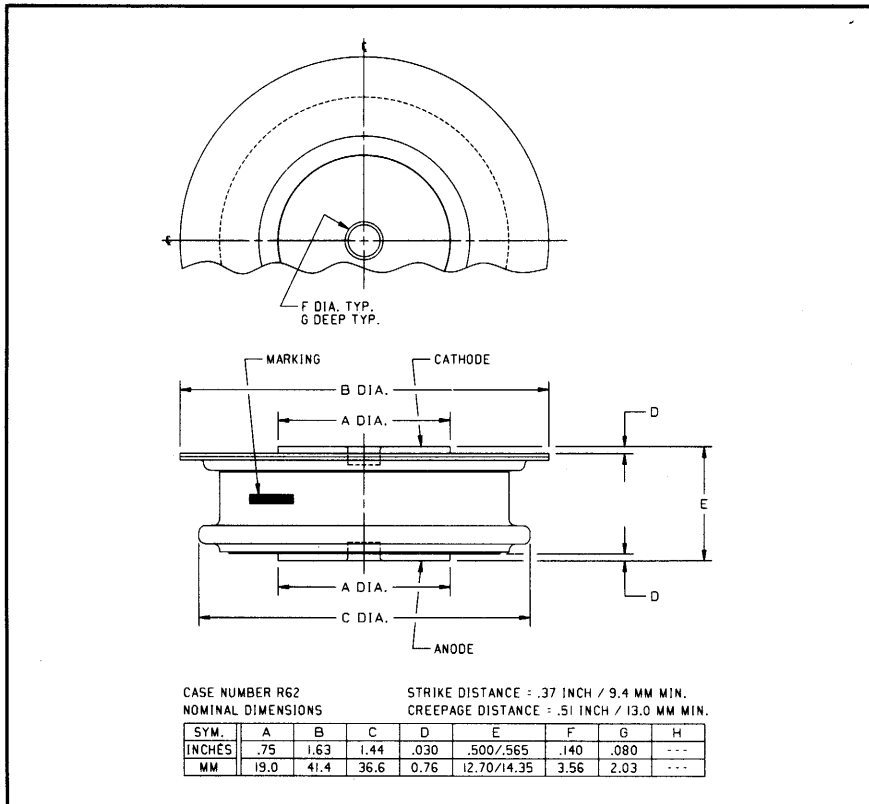

R620 (Outline Drawing)

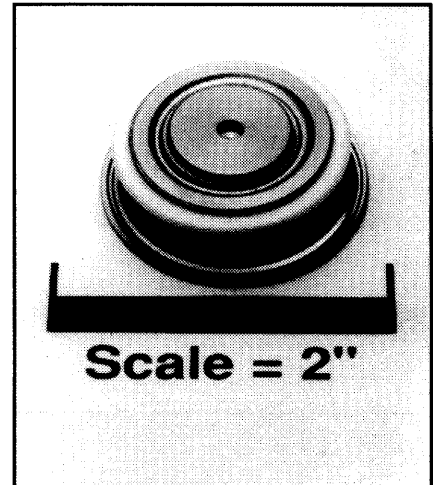

R620  
 General Purpose Rectifier  
 300-500 Amperes, 2400 Volts

### Ordering Information:

Select the complete part number you desire from the following table:

Type	Voltage		Current		Recovery Time		Recovery Time Circuit		Leads	
	V <sub>RRM</sub> (Volts)	Code	I <sub>F(av)</sub> (A)	Code	t <sub>rr</sub> (μsec)	Code	Circuit	Code	Case	Code
R620	200	02	300	30	11	X	JEDEC	X	R62	00
	400	04								
	600	06	400	40	9	X				
	800	08								
	1000	10	500	50	6	X				
	1200	12			(Typical)					
	1400	14								
	1600	16								
	1800	18								
	2000	20								
	2200	22								
	2400	24								

Example: Type R620 rated at 500A average with V<sub>RRM</sub> = 2400V

Type	Voltage	Current	Time	Circuit	Leads
R 6 2 0	2 4	5 0	X	X	0 0

### Features:

- High Surge Current Ratings
- High Rated Blocking Voltages
- Special Electrical Selection for Parallel and Series Operation
- Single or Double-sided Cooling
- Long Creepage and Strike Paths
- Hermetic Seal

### Applications:

- Rectification
- Free Wheeling Diode
- Battery Chargers
- Resistance Welding



Powerex, Inc., 200 Hillis Street, Youngwood, Pennsylvania 15697-1800 (412) 925-7272  
 Powerex, Europe, S.A. 428 Avenue G. Durand, BP107, 72003 Le Mans, France (43) 41.14.14

**R620**  
**General Purpose Rectifier**  
 300-500 Amperes, 2400 Volts

### Absolute Maximum Ratings

Characteristics	Symbol	R620_30	R620_40	R620_50	Units
RMS Forward Current	$I_{F(rms)}$	470	625	785	Amperes
Average Forward Current	$I_{F(av)}$	300	400	500	Amperes
One-half Cycle Surge Current	$I_{FSM}$	5500	6000	6500	Amperes
3 Cycle Surge Current	$I_{FSM}$	4300	4700	5050	Amperes
10 Cycle Surge Current	$I_{FSM}$	3300	3600	3900	Amperes
$I^2t$ (for Fusing), Times = 8.3 milliseconds	$I^2t$	125000	150000	175000	$A^2sec$
Max. $I^2t$ of Package (t = 8.3ms)	$I^2t$	$20 \times 10^6$	$20 \times 10^6$	$20 \times 10^6$	$A^2sec$
Storage Temperature	$T_{stg}$	-65 to +190	-65 to +190	-65 to +190	$^{\circ}C$
Operating Temperature	$T_j$	Up to 1400V -65 to +190	1400V to 2200V -65 to +175	2200V to 2600V -65 to +150	$^{\circ}C$
Mounting Force		1000 to 1400	1000 to 1400	1000 to 1400	lbs

### Electrical and Thermal Characteristics

Characteristics	Symbol	Test Conditions	R620_30	R620_40	R620_50	Units
<b>Current - Conducting State Maximums</b>						
Forward Voltage Drop	$V_{FM}$	$T_j = 25^{\circ}C, I_{FM} = 800A$	1.70	1.50	1.40	Volts
<b>Voltage - Blocking State Maximums</b>						
Repetitive Peak Reverse Voltage (Rated Limit)	$V_{RRM}$		2400	2400	2400	Volts
Non-rep. Trans. Peak Rev. Voltage (Rated Limit)	$V_{RSM}$	$t \leq 5.0\mu sec$	2600	2600	2600	Volts
Reverse Leakage Current	$I_{RRM}$	$T_j$ at max., $V_{RRM}$ Rated	50	50	50	mA
<b>Switching</b>						
Typical Reverse Recovery Time	$t_{rr}$	$I_{FM} = 785A, t_p = 100\mu sec,$ $di_F/dt = 25A/msec,$ $T_C = 25^{\circ}C$	Up to 1400V 6	1400V to 2200V 9	2200V to 2600V 11	$\mu sec$
<b>Thermal</b>						
Maximum Resistance, Double-sided Cooling, Junction to Case	$R_{\theta(j-c)}$		0.095	0.095	0.095	$^{\circ}C/Watt$
Maximum Resistance, Case to Sink (Lubricated)	$R_{\theta(c-s)}$		0.02	0.02	0.02	$^{\circ}C/Watt$

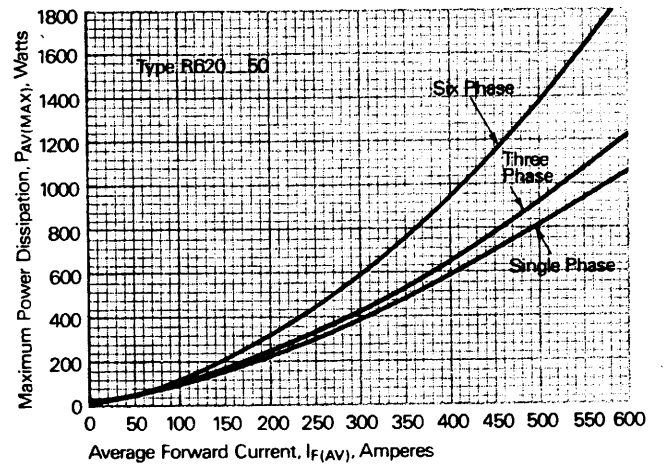
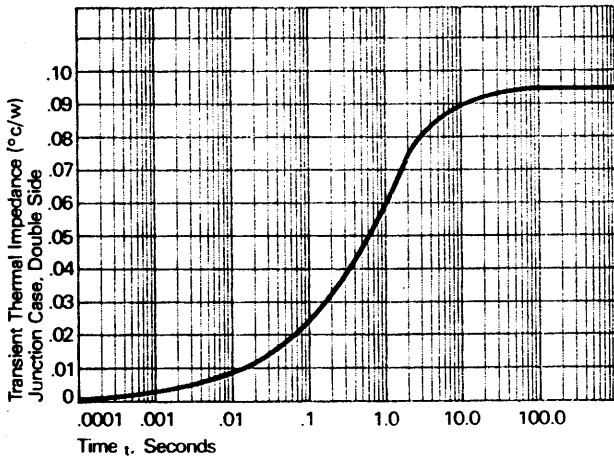
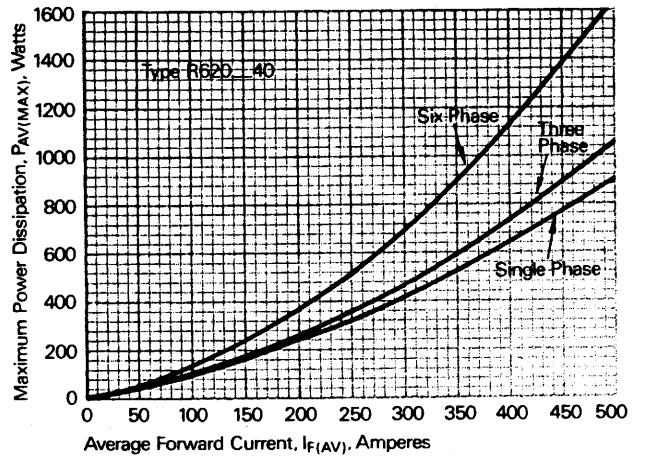
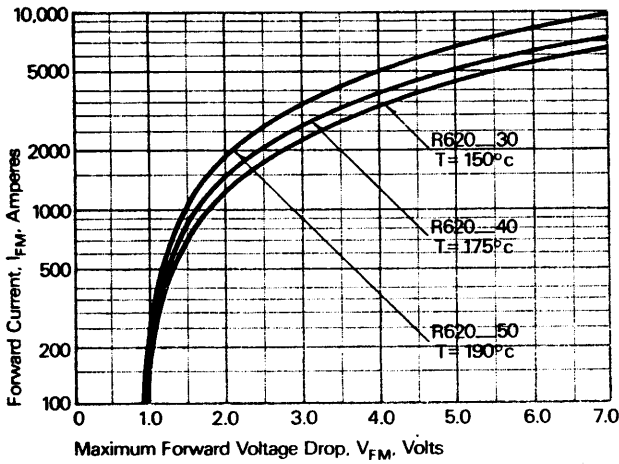
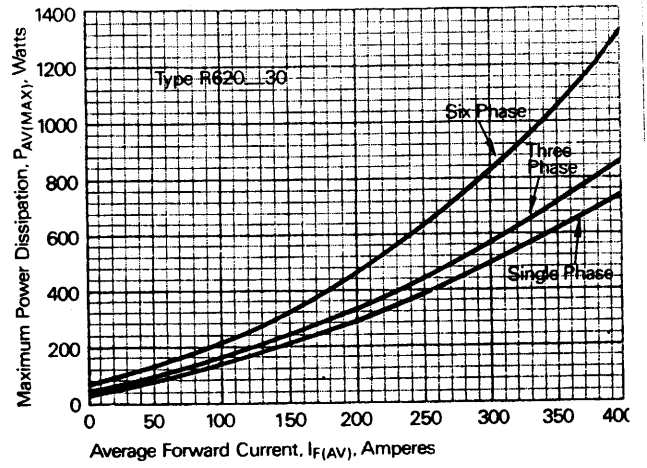
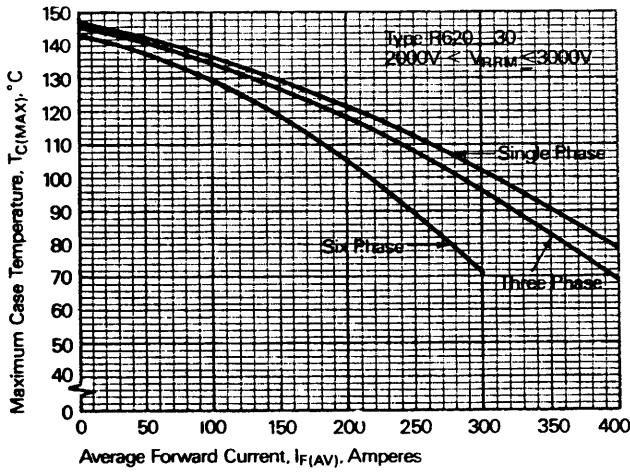

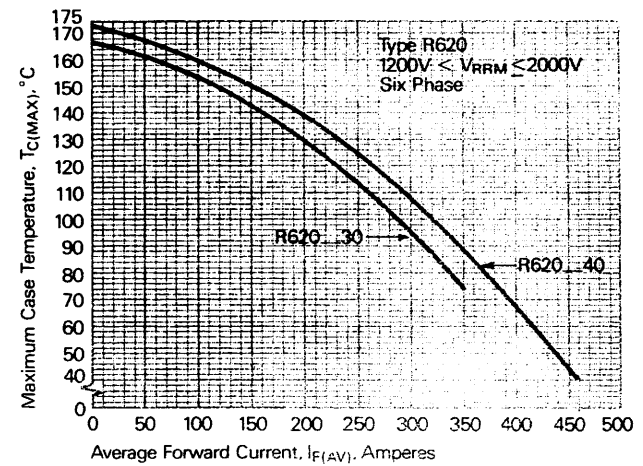
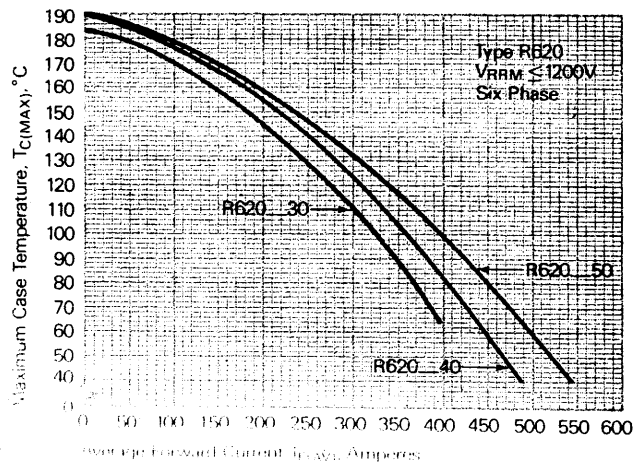
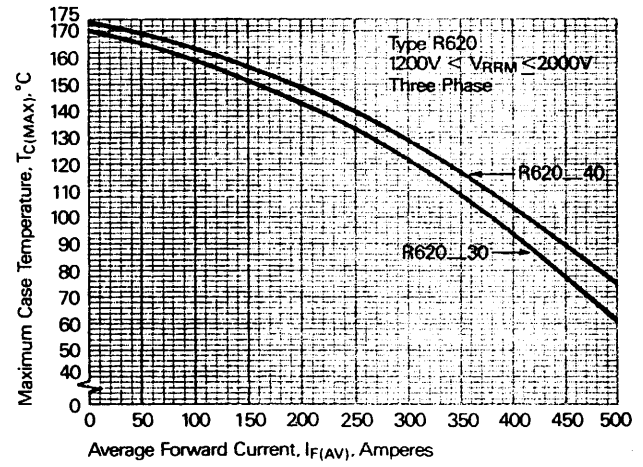
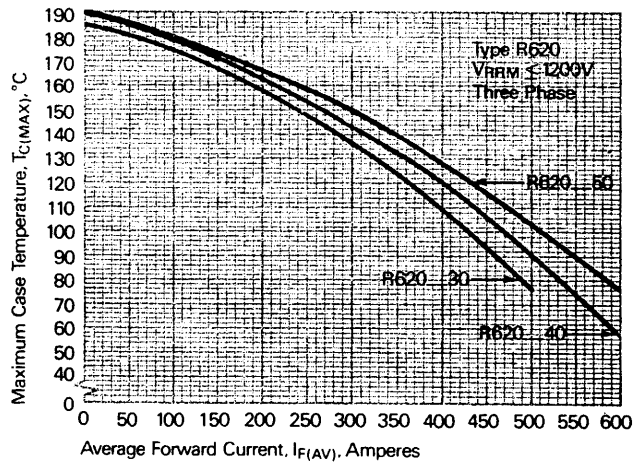
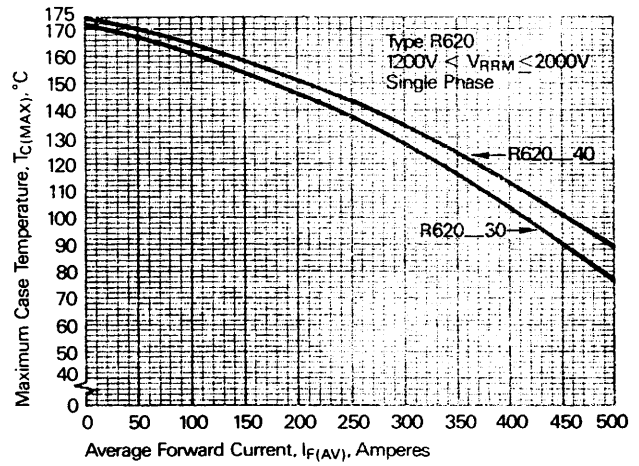
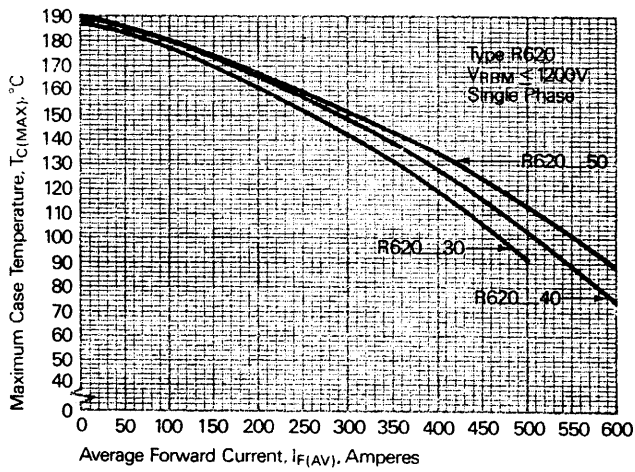

## Looking for pricing, stock, or lifecycle information?

Click below to explore more details on WIN SOURCE:

 [View R6200240XXOO on WIN SOURCE](#)

 [Powerex Inc. Information](#)

## Optimize Your Supply Chain with WIN SOURCE Solutions

-  Global Sourcing Solution
-  Obsolete Management
-  Cost Control Management
-  Shortage Management
-  Alternative Solution
-  Excess Inventory Management