



**THE DATASHEET OF
S242B681K502CT**



APPROVAL SHEET

MULTILAYER CERAMIC CAPACITORS

Safety Certified X1/Y2, S2 Series

1808 to 2220 Sizes

NP0 & X7R Dielectrics

Halogen Free & RoHS Compliance

*Contents in this sheet are subject to change without prior notice.

Multilayer Ceramic Capacitors

1. DESCRIPTION

WTC's SAFETY CERTIFIED CAPACITORS are designed for surge or lightning immunity in modem facsimile and other equipments. The capacitors of series S2 are class X1/Y2 compliant respectively.

The green type capacitors in S2 and S3 series are manufactured by using environmentally friendly materials without lead or cadmium.

The terminations are composed of plated nickel and pure tin to feature the superior leaching resistance during soldering.

2. FEATURES

- a. High reliability and stability.
- b. Small size and high capacitance
- c. RoHS compliant
- d. Safety standard approval by
EN 60384-14 : 2013
IEC 60384-14 : 2013
UL 60384-14 (Ed 2.0)
- e. Certificate number:
TUV: R50381780
UL: E182369
- f. HALOGEN compliant.

3. APPLICATIONS

- a. Modem.
- b. Facsimile.
- c. Telephone.
- d. Other electronic equipment for lightning or surge protection and isolation



4. HOW TO ORDER

S2	42	N	100	J	502	K	I
Series	Size	Dielectric	Capacitance	Tolerance	Impulse voltage	Termination	Packaging
S2=X1/Y2 Safety Certified	42=1808 (4520) 43=1812 (4532) 52=2211 (5728) 55=2220 (5750)	N=NP0 B=X7R	Two significant digits followed by no. of zeros. And R is in place of decimal point. eg.: 0R5=0.5pF 1R0=1.0pF 100=10x10 ⁰ =10pF	C= ±0.25pF D= ±0.5pF F= ±1.0% G= ±2.0% J= ±5.0% K= ±10% M= ±20%	Two significant digits followed by no. of zeros. And R is in place of decimal point. 502: 5000V Impulse Voltage 602: 6000V Impulse Voltage	E= Soft termination Z= Soft termination + Surface Coating M= Surface Coating (Specific product) K= Non Coating (Specific product)	T=7" reeled G=13" reeled

Multilayer Ceramic Capacitors

5. EXTERNAL DIMENSIONS & STRUCTURE

5-1 Safety certified Caps.

Size Inch (mm)	L (mm)	W (mm)	T (mm)	M _B (mm)
1808 (4520)	4.50 +0.8/-0.3	2.00±0.25	1.25±0.10 (D) 1.40±0.15 (F)	0.50±0.25
1812 (4532)	4.50 +0.8/-0.3	3.20±0.40	1.60±0.20 (G)	0.50±0.25
2211 (5728)	5.70±0.40	2.80±0.30	2.00±0.20 (K) 2.50±0.30 (M)	0.60±0.30
2220 (5750)	5.70±0.40	5.00±0.40	2.80±0.30 (U)	0.60±0.30

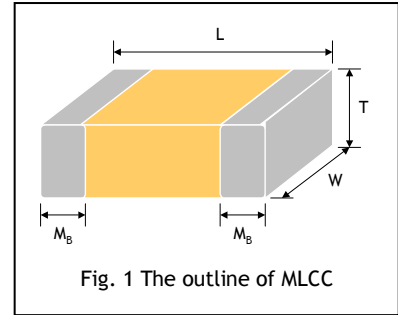

5-2 Safety certified Caps. with soft termination

Size Inch (mm)	L (mm)	W (mm)	T (mm)	M _B (mm)
1808 (4520)	4.50 +0.9/-0.3	2.00±0.30	1.25±0.10 (D) 1.40±0.15 (F)	0.50±0.25
1812 (4532)	4.50 +0.9/-0.3	3.20±0.40	1.60±0.20 (G)	0.50±0.25
2211 (5728)	5.70±0.50	2.80±0.40	2.00±0.20 (K) 2.50±0.30 (M)	0.60±0.30
2220 (5750)	5.70±0.50	5.00±0.50	2.80±0.30 (U)	0.60±0.30

Reflow soldering only is recommended

6. GENERAL ELECTRICAL DATA

Dielectric	NPO	X7R
Size	1808, 1812, 2211	1808, 1812, 2211, 2220
Capacitance	3pF to 680pF	100pF to 4700pF
Capacitance tolerance	Cap.<10pF: C (±0.25pF), D (±0.5pF) Cap.≥10pF: F (±1%), G (±2%), J (±5%), K (±10%), M (±20%)	J (±5%), K (±10%), M (±20%)
Rated voltage (WVAC)	250Vac	
Q/ DF(Tan δ)	Cap<30pF: Q≥400+20C _{NCE} Cap≥30pF: Q≥1000	DF≤2.5%
Insulation resistance at U _r	≥10GΩ	
Peak impulse voltage	5000V ~ 6000V	
Operating temperature	-55 to +125°C	
Capacitance characteristic	±30ppm/°C	±15%
Termination	Ni/Sn (lead-free termination)	
Certified number	TUV: R50195920, TUV: R50381780, UL: E182369	
Test standard	EN 60384-14 : 2013, IEC 60384-14 : 2013, UL 60384-14 (Ed 2.0)	

* NPO: Apply 1.0±0.2Vrms, 1.0MHz±10% for Cap≤1000pF and 1.0±0.2Vrms, 1.0kHz±10% for Cap>1000pF, at 25°C ambient temperature.

* X7R: Apply 1.0±0.2Vrms, 1.0kHz±10%, at 25°C ambient temperature.

7. PACKAGE DIMENSION AND QUANTITY

Size	Thickness (mm)/Symbol		Plastic tape	
			7" reel	13" reel
1808 (4520)	1.40±0.15	F	2k	10k
	1.60±0.20	G	2k	8k
	2.00±0.20	K	1k	6k
1812 (4532)	1.25±0.10	D	1k	5k
	1.60±0.20	G	1k	4k
	2.00±0.20	K	1k	3k
	2.50±0.30	M	0.5k	3k
2211 (5728)	1.60±0.20	G	1k	4k
	2.00±0.20	K	1k	3k
	2.50±0.30	M	0.5k	3k
	2.80±0.30	U	0.5k	-
2220 (5750)	2.00±0.20	K	1k	3k
	2.50±0.30	M	0.5k	2k

Unit: pieces

Multilayer Ceramic Capacitors

8. CAPACITANCE RANGE

- ☑ “+” mark: Surface coating is the standard product.
- ☑ “-” mark: Non-surface coating is the standard product.

DIELECTRIC		NP0							
		1808		1812		2211		2211	
SIZE		5000							
PEAK IMPULSE VOLTAGE		5000				6000			
Certificated		TUV	UL	TUV	UL	TUV	UL	TUV	UL
		IEC60384-14	60384	IEC60384-14	60384	IEC60384-14	60384	IEC60384-14	60384
Capacitance	3.0pF (3R0)	F ⁻	F ⁻						
	3.3pF (3R3)	F ⁻	F ⁻						
	3.9pF (3R9)	F ⁻	F ⁻						
	4.0pF (4R0)	F ⁻	F ⁻			K ⁻	K ⁻	K ⁻	K ⁻
	4.7pF (4R7)	F ⁻	F ⁻			K ⁻	K ⁻	K ⁻	K ⁻
	5.0pF (5R0)	F ⁻	F ⁻			K ⁻	K ⁻	K ⁻	K ⁻
	5.6pF (5R6)	F ⁻	F ⁻			K ⁻	K ⁻	K ⁻	K ⁻
	6.0pF (6R0)	F ⁻	F ⁻			K ⁻	K ⁻	K ⁻	K ⁻
	6.8pF (6R8)	F ⁻	F ⁻			K ⁻	K ⁻	K ⁻	K ⁻
	7.0pF (7R0)	F ⁻	F ⁻			K ⁻	K ⁻	K ⁻	K ⁻
	8.0pF (8R0)	F ⁻	F ⁻			K ⁻	K ⁻	K ⁻	K ⁻
	8.2pF (8R2)	F ⁻	F ⁻			K ⁻	K ⁻	K ⁻	K ⁻
	9.0pF (9R0)	F ⁻	F ⁻			K ⁻	K ⁻	K ⁻	K ⁻
	10pF (100)	F ⁻	F ⁻	D ⁻	D ⁻	K ⁻	K ⁻	K ⁻	K ⁻
	12pF (120)	F ⁻	F ⁻	D ⁻	D ⁻	K ⁻	K ⁻	K ⁻	K ⁻
	15pF (150)	F ⁻	F ⁻	D ⁻	D ⁻	K ⁻	K ⁻	K ⁻	K ⁻
	18pF (180)	F ⁻	F ⁻	D ⁻	D ⁻	K ⁻	K ⁻	K ⁻	K ⁻
	22pF (220)	F ⁻	F ⁻	D ⁻	D ⁻	K ⁻	K ⁻	K ⁻	K ⁻
	27pF (270)	F ⁻	F ⁻	D ⁻	D ⁻	K ⁻	K ⁻	K ⁻	K ⁻
	33pF (330)	F ⁻	F ⁻	D ⁻	D ⁻	K ⁻	K ⁻	K ⁻	K ⁻
	39pF (390)	G ⁻	G ⁻	D ⁻	D ⁻	K ⁻	K ⁻	K ⁻	K ⁻
	47pF (470)	G ⁻	G ⁻	D ⁻	D ⁻	K ⁻	K ⁻	K ⁻	K ⁻
	56pF (560)	G ⁻	G ⁻	D ⁻	D ⁻	K ⁻	K ⁻	K ⁻	K ⁻
	68pF (680)	G ⁻	G ⁻	D ⁻	D ⁻	K ⁻	K ⁻	M ⁻	M ⁻
	82pF (820)	G ⁻	G ⁻	D ⁻	D ⁻	K ⁻	K ⁻	M ⁻	M ⁻
	100pF (101)	K ⁻	K ⁻	D ⁻	D ⁻	K ⁻	K ⁻	U ⁻	U ⁻
	120pF (121)	K ⁻	K ⁻	D ⁻	D ⁻	M ⁻	M ⁻		
	130pF (131)	K ⁻	K ⁻	D ⁻	D ⁻	M ⁻	M ⁻		
	150pF (151)	K ⁻	K ⁻	D ⁻	D ⁻	M ⁻	M ⁻		
	160pF (161)	K ⁻	K ⁻	D ⁻	D ⁻	M ⁻	M ⁻		
180pF (181)	K ⁻	K ⁻	D ⁻	D ⁻	M ⁻	M ⁻			
220pF (221)	K ⁻	K ⁻	K ⁻	K ⁻	M ⁻	M ⁻			
270pF (271)	K ⁻	K ⁻	K ⁻	K ⁻	M ⁻	M ⁻			
300pF (301)			K ⁻	K ⁻	M ⁻	M ⁻			
330pF (331)			K ⁻	K ⁻	M ⁻	M ⁻			
390pF (391)			K ⁻	K ⁻	M ⁻	M ⁻			
470pF (471)			K ⁻	K ⁻	M ⁻	M ⁻			
560pF (561)					M ⁻	M ⁻			
680pF (681)					M ⁻	M ⁻			
720pF (721)									

1. The letter in cell is expressed the symbol of product thickness.
2. For more information about products with special capacitance or other data, please contact WTC local representative.

Multilayer Ceramic Capacitors

- ☐ “+” mark: Surface coating is the standard product.
- ☐ “-” mark: Non-surface coating is the standard product.

DIELECTRIC		X7R								
SIZE		1808		1812		2211		2220		
PEAK IMPULSE VOLTAGE		5000								
Certificated	TUV IEC60384-14	UL 60384	TUV IEC60384-14	UL 60384	TUV IEC60384-14	UL 60384	TUV IEC60384-14	UL 60384	TUV IEC60384-14	UL 60384
120pF (121)	G ⁺	G ⁺					G ⁺	G ⁺		
130pF (131)	G ⁺	G ⁺					G ⁺	G ⁺		
150pF (151)	G ⁺	G ⁺	G ⁺	G ⁺			G ⁺	G ⁺		
160pF (161)	G ⁺	G ⁺	G ⁺	G ⁺	G ⁺	G ⁺	G ⁺	G ⁺	K ⁺	K ⁺
180pF (181)	G ⁺	G ⁺	G ⁺	G ⁺	G ⁺	G ⁺	G ⁺	G ⁺	K ⁺	K ⁺
220pF (221)	G ⁺	G ⁺	G ⁺	G ⁺	G ⁺	G ⁺	G ⁺	G ⁺	K ⁺	K ⁺
270pF (271)	K ⁺	K ⁺	G ⁺	G ⁺	G ⁺	G ⁺	G ⁺	G ⁺	K ⁺	K ⁺
300pF (301)	K ⁺	K ⁺	G ⁺	G ⁺	G ⁺	G ⁺	G ⁺	G ⁺	K ⁺	K ⁺
330pF (331)	K ⁺	K ⁺	G ⁺	G ⁺	G ⁺	G ⁺	G ⁺	G ⁺	K ⁺	K ⁺
390pF (391)	K ⁺	K ⁺	G ⁺	G ⁺	G ⁺	G ⁺	G ⁺	G ⁺	K ⁺	K ⁺
470pF (471)	K ⁺	K ⁺	G ⁺	G ⁺	K ⁺	K ⁺	K ⁺	K ⁺	K ⁺	K ⁺
560pF (561)	K ⁺	K ⁺	G ⁺	G ⁺	K ⁺	K ⁺	K ⁺	K ⁺	K ⁺	K ⁺
680pF (681)	K ⁺	K ⁺	K ⁺	K ⁺	K ⁺	K ⁺	K ⁺	K ⁺	K ⁺	K ⁺
720pF (721)	K ⁺	K ⁺	K ⁺	K ⁺	K ⁺	K ⁺	K ⁺	K ⁺	K ⁺	K ⁺
820pF (821)	K ⁺	K ⁺	K ⁺	K ⁺	K ⁺	K ⁺	K ⁺	K ⁺	K ⁺	K ⁺
1,000pF (102)	K ⁺	K ⁺	M ⁺	M ⁺	M ⁺	M ⁺	M ⁺	M ⁺	K ⁺	K ⁺
1,200pF (122)					M ⁺	M ⁺	M ⁺	M ⁺	M ⁺	M ⁺
1,500pF (152)					M ⁺	M ⁺	M ⁺	M ⁺	M ⁺	M ⁺
1,800pF (182)					M ⁺	M ⁺	M ⁺	M ⁺	M ⁺	M ⁺
2,200pF (222)					M ⁺	M ⁺	M ⁺	M ⁺	M ⁺	M ⁺
2,700pF (272)					U ⁺	U ⁺			M ⁺	M ⁺
3,300pF (332)									M ⁺	M ⁺
3,900pF (392)									M ⁺	M ⁺
4,700pF (472)									M ⁺	M ⁺

1. The letter in cell is expressed the symbol of product thickness.
2. For more information about products with special capacitance or other data, please contact WTC local representative.

Multilayer Ceramic Capacitors

9. RELIABILITY TEST CONDITIONS AND REQUIREMENTS

No.	Item	Standard Method	Test Condition	Requirements																										
1.	Visual examination and Dimensions	IEC 60384-1 4.1		* No remarkable defect. * Dimensions to confirm to individual specification sheet.																										
2.	Capacitance	IEC 60384-1 4.2.2	* Test temp.: Room Temperature. * Class I : (C0G) Cap.≤1000pF, 1.0±0.2Vrms, 1MHz±10%. Cap.>1000pF, 1.0±0.2Vrms, 1KHz±10%.	* Capacitance is within specified tolerance. * C _R means rated capacitance for conform to the E6 series of preferred values given in IEC 60063.																										
3.	D.F. (Dissipation Factor) Tangent of loss angle	IEC 60384-1 4.2.3	* Class II : (X7R) 1.0±0.2Vrms, 1KHz±10%.	<table border="1"> <thead> <tr> <th>Dielectric</th> <th>Q/D.F.</th> <th>Remark</th> </tr> </thead> <tbody> <tr> <td rowspan="2">Class I (C0G)</td> <td>Q≥1000</td> <td>Cap.≥30pF</td> </tr> <tr> <td>Q≥400+20C</td> <td>Cap.<30pF</td> </tr> <tr> <td>Class II (X7R)</td> <td>D.F.≤2.5%</td> <td></td> </tr> </tbody> </table>	Dielectric	Q/D.F.	Remark	Class I (C0G)	Q≥1000	Cap.≥30pF	Q≥400+20C	Cap.<30pF	Class II (X7R)	D.F.≤2.5%																
Dielectric	Q/D.F.	Remark																												
Class I (C0G)	Q≥1000	Cap.≥30pF																												
	Q≥400+20C	Cap.<30pF																												
Class II (X7R)	D.F.≤2.5%																													
4.	Temperature Coefficient	IEC 60384-21/22 4.6	With no electrical load. <table border="1"> <thead> <tr> <th>T.C.</th> <th>Operating Temp</th> </tr> </thead> <tbody> <tr> <td>C0G(NP0)</td> <td>-55~125°C at 25°C</td> </tr> <tr> <td>X7R</td> <td>-55~125°C at 25°C</td> </tr> </tbody> </table>	T.C.	Operating Temp	C0G(NP0)	-55~125°C at 25°C	X7R	-55~125°C at 25°C	<table border="1"> <thead> <tr> <th>T.C.</th> <th>Capacitance Change</th> </tr> </thead> <tbody> <tr> <td>C0G(NP0)</td> <td>Within ±30ppm/°C</td> </tr> <tr> <td>X7R</td> <td>Within ±15%</td> </tr> </tbody> </table>	T.C.	Capacitance Change	C0G(NP0)	Within ±30ppm/°C	X7R	Within ±15%														
T.C.	Operating Temp																													
C0G(NP0)	-55~125°C at 25°C																													
X7R	-55~125°C at 25°C																													
T.C.	Capacitance Change																													
C0G(NP0)	Within ±30ppm/°C																													
X7R	Within ±15%																													
5.	Voltage proof (Dielectric Strength)	IEC 60384-14 4.2.1	* To apply voltage : X Capacitor : 1075Vdc (4.3U _R). Y Capacitor : 1500Vac. * Duration : 60 sec. * The charge current shall not exceed 0.05A. * The voltage shall be raised from the near zero to the test voltage at a rate not exceeding 150V(r.m.s.)/sec.	* No evidence of damage or flash over during test.																										
6.	Insulation Resistance	IEC 60384-21/22 4.5.3	<table border="1"> <thead> <tr> <th>Rated Vol.(V)</th> <th>Apply Voltage</th> <th>Charge Current</th> <th>Charge Time</th> </tr> </thead> <tbody> <tr> <td>>500</td> <td>500Vdc</td> <td>≤50mA</td> <td>60 sec.</td> </tr> </tbody> </table> *Test temp.: Room Temperature.	Rated Vol.(V)	Apply Voltage	Charge Current	Charge Time	>500	500Vdc	≤50mA	60 sec.	<table border="1"> <thead> <tr> <th>Dielectric</th> <th>Requirements</th> </tr> </thead> <tbody> <tr> <td>Class I (C0G)</td> <td>≥100GΩ or RxC≥1000Ω-F, whichever is smaller</td> </tr> <tr> <td>Class II (X7R)</td> <td>≥10GΩ or RxC≥500Ω-F, whichever is smaller</td> </tr> </tbody> </table>	Dielectric	Requirements	Class I (C0G)	≥100GΩ or RxC≥1000Ω-F, whichever is smaller	Class II (X7R)	≥10GΩ or RxC≥500Ω-F, whichever is smaller												
Rated Vol.(V)	Apply Voltage	Charge Current	Charge Time																											
>500	500Vdc	≤50mA	60 sec.																											
Dielectric	Requirements																													
Class I (C0G)	≥100GΩ or RxC≥1000Ω-F, whichever is smaller																													
Class II (X7R)	≥10GΩ or RxC≥500Ω-F, whichever is smaller																													
7.	Solderability	IEC 60384-21/22 4.10	* Solder temperature: 235±5°C(0201~1210). * Solder temperature: 245±5°C(1808~2225). * Dipping time : 2±0.5 sec.	* 75% min. coverage of all metalized area.																										
8.	Resistance to Soldering Heat	IEC 60384-14 4.4 IEC 60384-21/22 4.9	* Solder temperature : 260±5°C. * Dipping time : 10±1 sec. * Preheating : 120 to 150°C for 1 minute before immerse the capacitor in a eutectic solder. * Measurement to be made after keeping at room temperature for 24±2 hrs.	<table border="1"> <thead> <tr> <th>Dielectric</th> <th>I.R.</th> <th>Cap. Change</th> <th>Q/D.F.</th> </tr> </thead> <tbody> <tr> <td>Class I (C0G)</td> <td>≥1GΩ</td> <td>Within ±2.5% or ±0.25pF, whichever is larger</td> <td>≤100% of initial requirement</td> </tr> <tr> <td>Class II (X7R)</td> <td>≥1GΩ</td> <td>Within ±7.5%</td> <td></td> </tr> </tbody> </table>	Dielectric	I.R.	Cap. Change	Q/D.F.	Class I (C0G)	≥1GΩ	Within ±2.5% or ±0.25pF, whichever is larger	≤100% of initial requirement	Class II (X7R)	≥1GΩ	Within ±7.5%															
Dielectric	I.R.	Cap. Change	Q/D.F.																											
Class I (C0G)	≥1GΩ	Within ±2.5% or ±0.25pF, whichever is larger	≤100% of initial requirement																											
Class II (X7R)	≥1GΩ	Within ±7.5%																												
9.	Temperature Cycle	IEC 60384-21/22 4.11	* Conduct the five cycles according to the temperatures and time. <table border="1"> <thead> <tr> <th>Step</th> <th>Temp.(°C)</th> <th>Time(min.)</th> </tr> </thead> <tbody> <tr> <td>1</td> <td>Min. operating temp. +0/-3</td> <td>30±3</td> </tr> <tr> <td>2</td> <td>Room temp.</td> <td>2~3</td> </tr> <tr> <td>3</td> <td>Max.operating temp. +3/-0</td> <td>30±3</td> </tr> <tr> <td>4</td> <td>Room temp.</td> <td>2~3</td> </tr> </tbody> </table> * Measurement to be made after keeping at room temperature for 24±2 hrs.	Step	Temp.(°C)	Time(min.)	1	Min. operating temp. +0/-3	30±3	2	Room temp.	2~3	3	Max.operating temp. +3/-0	30±3	4	Room temp.	2~3	<table border="1"> <thead> <tr> <th>Dielectric</th> <th>I.R.</th> <th>Cap. Change</th> <th>Q/D.F.</th> </tr> </thead> <tbody> <tr> <td>Class I (C0G)</td> <td rowspan="2">To meet initial requirement</td> <td>Within ±2.5% or ±0.25pF, whichever is larger</td> <td>≤1.0(Q) × initial requirement</td> </tr> <tr> <td>Class II (X7R)</td> <td>Within ±7.5%</td> <td>≤1.5(D.F.) × initial requirement</td> </tr> </tbody> </table>	Dielectric	I.R.	Cap. Change	Q/D.F.	Class I (C0G)	To meet initial requirement	Within ±2.5% or ±0.25pF, whichever is larger	≤1.0(Q) × initial requirement	Class II (X7R)	Within ±7.5%	≤1.5(D.F.) × initial requirement
Step	Temp.(°C)	Time(min.)																												
1	Min. operating temp. +0/-3	30±3																												
2	Room temp.	2~3																												
3	Max.operating temp. +3/-0	30±3																												
4	Room temp.	2~3																												
Dielectric	I.R.	Cap. Change	Q/D.F.																											
Class I (C0G)	To meet initial requirement	Within ±2.5% or ±0.25pF, whichever is larger	≤1.0(Q) × initial requirement																											
Class II (X7R)		Within ±7.5%	≤1.5(D.F.) × initial requirement																											

* "Room condition" Temperature: 15 to 35°C, Relative humidity: 25 to 75%, Atmospheric pressure: 86 to 106kPa.

Multilayer Ceramic Capacitors

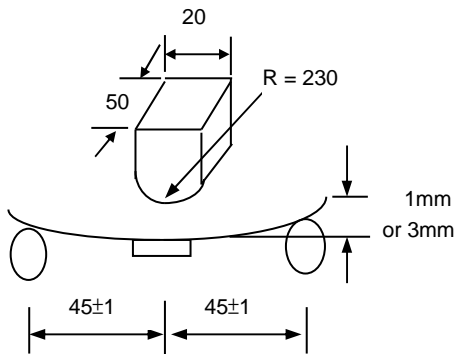
No.	Item	Standard Method	Test Condition	Requirements												
10.	Humidity (Damp Heat) Steady State	IEC 60384-14 4.12	* Test temp. : 40±2°C. * Humidity : 90~95% RH. * Test time : 500 +24/-0hrs. * Applied voltage : 250Vac. * Measurement to be made after keeping at room temp. for 24±2 hrs (Class I) and 48±4 hrs (Class II).	* No remarkable damage. <table border="1"> <thead> <tr> <th>Dielectric</th> <th>I.R.</th> <th>Cap. Change</th> <th>Q/D.F.</th> </tr> </thead> <tbody> <tr> <td>Class I (C0G)</td> <td>≥1GΩ or RxC≥25Ω-F, whichever is smaller</td> <td>Within ±3.0% or ±2pF, whichever is larger</td> <td>≤0.25%</td> </tr> <tr> <td>Class II (X7R)</td> <td></td> <td>Within ±15%</td> <td>≤2.0(D.F.) x initial requirement</td> </tr> </tbody> </table>	Dielectric	I.R.	Cap. Change	Q/D.F.	Class I (C0G)	≥1GΩ or RxC≥25Ω-F, whichever is smaller	Within ±3.0% or ±2pF, whichever is larger	≤0.25%	Class II (X7R)		Within ±15%	≤2.0(D.F.) x initial requirement
Dielectric	I.R.	Cap. Change	Q/D.F.													
Class I (C0G)	≥1GΩ or RxC≥25Ω-F, whichever is smaller	Within ±3.0% or ±2pF, whichever is larger	≤0.25%													
Class II (X7R)		Within ±15%	≤2.0(D.F.) x initial requirement													
11.	Passive Flammability	IEC 60384-14 4.17 IEC 60384-1 4.38	* Volume sample: 21.56 mm ³ * Flame exposure time: 5 sec Max. * Category of flammability : C.	* Capacitor didn't burn at all.												
12.	Active Flammability	IEC 60384-21/22 4.18	* The capacitors applied UR (250Vac). Then each sample shall be subjected to 20 discharges from a tank capacitor, charge to a voltage that, when discharged, phase Ui 2500V for X1Y2 across the capacitor under test. The interval between successive discharges shall be 5 sec.	* The cheese cloth shall not burn with a flame.												
13.	High Temperature Load (Endurance)	IEC 60384-14 4.14	* Impulse Voltage : Each individual capacitor shall be subjected to a Vp = 5.0KV (X1Y2 Class Impulse 5KV) & Vp = 6.0KV (X1Y2 Class Impulse 6KV) impulse for three times before applied to endurance test. * Test temp. : 125±3°C. * Test time: 1000 +48/-0 hrs. * Applied voltage : X capacitor: 1.25UR (312.5Vac). Y capacitor: 1.70UR (425Vac). Once every hour the voltage shall be increased to 1000Vrms for 0.1 sec. * Measurement to be made after keeping at room temp. for 24±2 hrs (Class I) and 48±4 hrs (Class II).	* Appearance : No mechanical damage. * Cap. change : C0G within ±5% or ±0.5pF, whichever is larger. X7R within ±20%. * D.F. value : C0G≤0.25%. X7R≤5.0%. * I.R.≥1GΩ. * Dielectric strength satisfies the specified initial value.												
14.	Resistance to Flexure of Substrate	IEC 60384-21/22 4.8	* The middle part of substrate shall be pressurized by means of the pressurizing rod at a rate of about 1mm per second until the deflection becomes: 1mm for standard termination product, 3mm for soft termination product. 	* No remarkable damage. <table border="1"> <thead> <tr> <th>Dielectric</th> <th>Cap. Change</th> </tr> </thead> <tbody> <tr> <td>Class I (C0G)</td> <td>Within ±3.0% or ±2pF, whichever is larger</td> </tr> <tr> <td>Class II (X7R)</td> <td>Within ±12.5%</td> </tr> </tbody> </table> (This capacitance change means the change of capacitance under specified flexure of substrate from the capacitance measured before the test)	Dielectric	Cap. Change	Class I (C0G)	Within ±3.0% or ±2pF, whichever is larger	Class II (X7R)	Within ±12.5%						
Dielectric	Cap. Change															
Class I (C0G)	Within ±3.0% or ±2pF, whichever is larger															
Class II (X7R)	Within ±12.5%															

* "Room condition" Temperature: 15 to 35°C, Relative humidity: 25 to 75%, Atmospheric pressure: 86 to 106kPa.

Multilayer Ceramic Capacitors

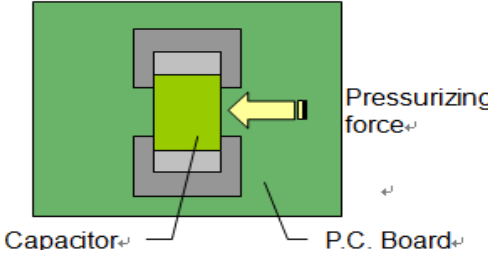
No.	Item	Standard Method	Test Condition	Requirements
15.	Adhesive Strength of Termination	IEC 60384-21/22 4.15 IEC 60384-1 4.13	<p>* Capacitors mounted on a substrate. A force of 10N applied perpendicular to the place of substrate and parallel the line joining the center of terminations for 10±1 sec.</p> 	* No remarkable damage or removal of the terminations.
16.	Vibration	IEC 60384-1 4.17	<p>* Reflow solder the capacitors on P. C. Board before test.</p> <p>* Vibration frequency : 10~55 Hz/min.</p> <p>* Total amplitude : 1.5mm.</p> <p>* Repeat the conditions for 2 hours each in 3 perpendicular directions.</p>	<p>* No remarkable damage.</p> <p>* Cap. change and Q/D.F. : To meet initial spec.</p>
17.	Impulse Voltage	IEC 60384-14 4.13	<p>* X1 : 4.0KV</p> <p>* Y2 : 5.0KV.</p> <p>* Number of impulse : 24 max.</p>	* There shall be no permanent breakdown or flashover.

* "Room condition" Temperature: 15 to 35°C, Relative humidity: 25 to 75%, Atmospheric pressure: 86 to 106kPa.

Multilayer Ceramic Capacitors

EMBOSSED TAPE DIMENSIONS

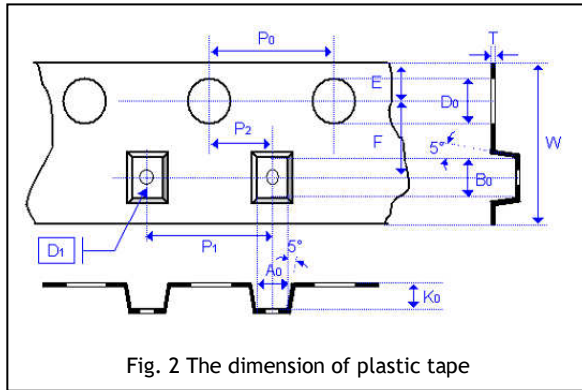

Fig. 2 The dimension of plastic tape

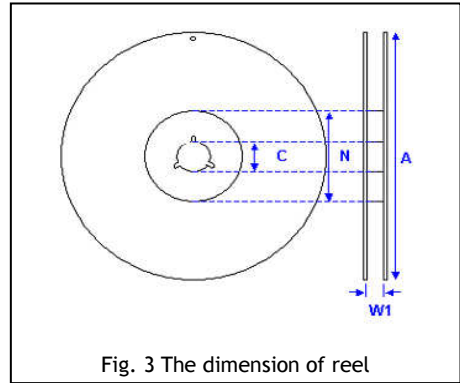

Fig. 3 The dimension of reel

Size	1808		1812		2211		2220		
Chip Thickness	1.25±0.10	2.00±0.20	1.25±0.10	2.50±0.30	1.60±0.20	2.50±0.30	2.00±0.20	2.50±0.30	
	1.40±0.15		1.60±0.20		2.00±0.20				2.80±0.30
	1.60±0.20		2.00±0.20						
A ₀	<2.50	<2.50	<3.90	<3.90	<3.30	<3.30	<5.80	<5.80	
B ₀	<6.00	<6.00	<6.00	<6.00	<6.50	<6.50	<6.50	<6.50	
T	0.25±0.10	0.25±0.10	0.25±0.10	0.25±0.10	0.30±0.10	0.30±0.10	0.30±0.10	0.30±0.10	
K ₀	<2.50	<2.50	<2.50	<3.50	<2.50	<3.50	<2.50	<3.50	
W	12.0±0.30	12.0±0.30	12.0±0.30	12.0±0.30	12.0±0.30	12.0±0.30	12.0±0.30	12.0±0.30	
P ₀	4.00±0.10	4.00±0.10	4.00±0.10	4.00±0.10	4.00±0.10	4.00±0.10	4.00±0.10	4.00±0.10	
10xP ₀	40.0±0.20	40.0±0.20	40.00±0.20	40.00±0.20	40.0±0.20	40.0±0.20	40.00±0.20	40.00±0.20	
P ₁	4.00±0.10	4.00±0.10	8.00±0.10	8.00±0.10	8.00±0.10	8.00±0.10	8.00±0.10	8.00±0.10	
P ₂	2.00±0.10	2.00±0.10	2.00±0.10	2.00±0.10	2.00±0.10	2.00±0.10	2.00±0.10	2.00±0.10	
D ₀	1.50+0.10/-0	1.50+0.10/-0	1.50+0.10/-0	1.50+0.10/-0	1.50+0.10/-0	1.50+0.10/-0	1.50+0.10/-0	1.50+0.10/-0	
D ₁	1.50±0.10	1.50±0.10	1.50±0.10	1.50±0.10	1.50±0.10	1.50±0.10	1.50±0.10	1.50±0.10	
E	1.75±0.10	1.75±0.10	1.75±0.10	1.75±0.10	1.75±0.10	1.75±0.10	1.75±0.10	1.75±0.10	
F	5.50±0.10	5.50±0.10	5.50±0.10	5.50±0.10	5.50±0.10	5.50±0.10	5.50±0.10	5.50±0.10	

Size	1808, 1812, 2211, 2220	
Reel size	7"	13"
C	13.0+0.5/-0.2	13.0+0.5/-0.2
W ₁	12.4+2.0/-0	12.4+2.0/-0
A	178.0±1.0	330.0±1.0
N	60.0+1.0/-0	100±1.0

▣ Peeling force (EIA-481)

Peel-off force should be in the range of 10 grams to 100 grams at a peel-off speed of 300±10 mm/min.

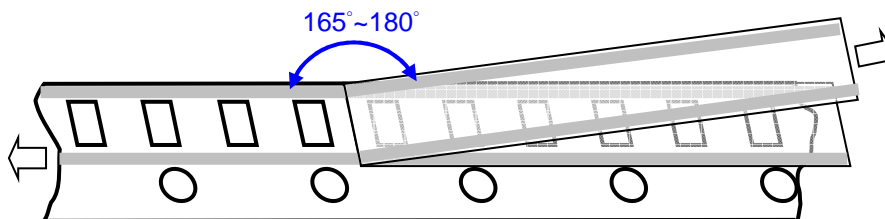

APPLICATION NOTES

Storage

To prevent the damage of solderability of terminations, the following storage conditions are recommended:

Indoors under 5 ~ 40°C and 20% ~ 70% RH; MSL Level 1.

No harmful gases containing sulfuric acid, ammonia, hydrogen sulfide or chlorine.

Packaging should not be opened until the capacitors are required for use. If opened, the pack should be re-sealed as soon as is practicable. Taped product should be stored out of direct sunlight, which might promote deterioration in tape or adhesion performance. The product is recommended to be used within 12 months after shipment and checked the solderability before use.

Handling

Chip capacitors are dense, hard, brittle, and abrasive materials. They are liable to suffer mechanical damage, in the form of cracks or chips. Chip Capacitors should be handled with care to avoid contamination or damage. To use vacuum or plastic tweezers to pick up or plastic tweezers is recommended for manual placement. Tape and reeled packages are suitable for automatic pick and placement machine.

Preheat

In order to minimize the risk of thermal shock during soldering, a carefully controlled preheat is required. The rate of preheat should not exceed 3°C per second.

Soldering

Use middy activated rosin RA and RMA fluxes do not use activated flux. The amount of solder in each solder joint should be controlled to prevent the damage of chip capacitors caused by the stress between solder, chips, and substrate.

a.) Hand soldering :

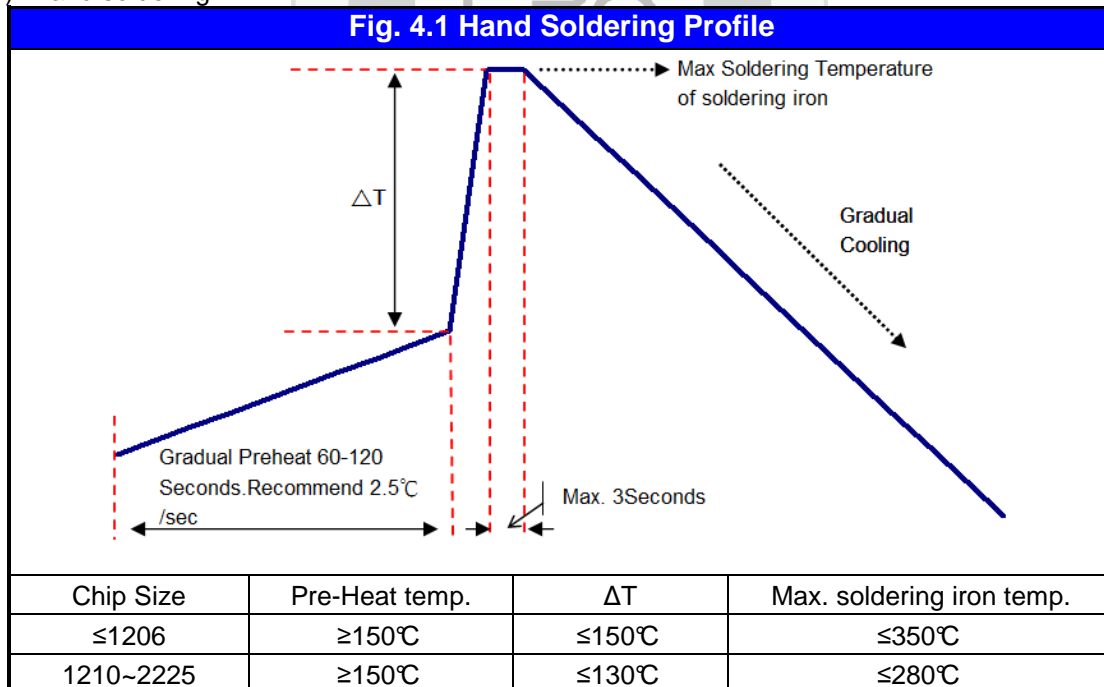

* Soldering iron tip diameter ≤ 1.0 mm and wattage max. 20W.

* The Capacitors shall be pre-heated and that the temperature gradient between the devices and the tip of the soldering iron.

* The required amount of solder shall be melted on the soldering tip.

* The tip of iron should not contact the ceramic body directly.

* The Capacitors shall be cooled gradually at room temperature after soldering.

* Forced air cooling is not allowed.

Multilayer Ceramic Capacitors

b.) Reflow soldering :

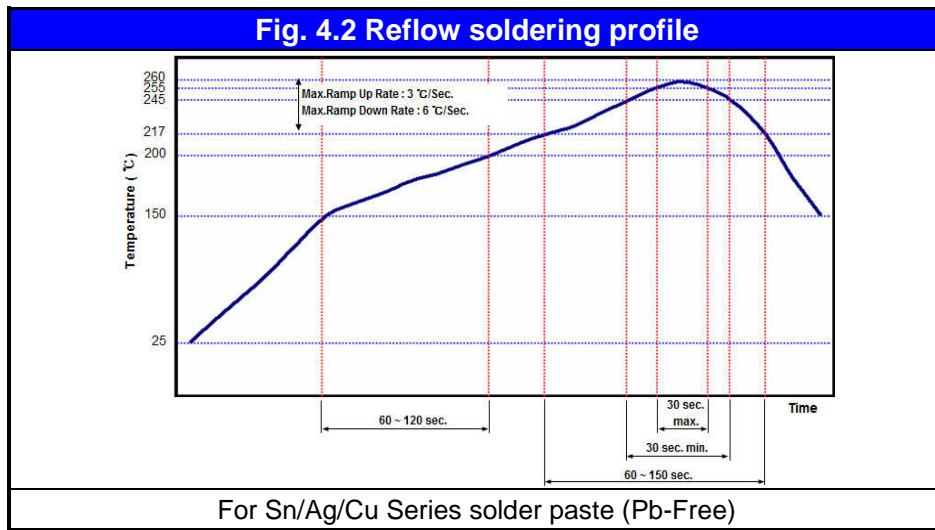

❑ **Cooling**

After soldering, cool the chips and the substrate gradually to room temperature. Natural cooling in air is recommended to minimize stress in the solder joint.

❑ **Cleaning**

All flux residues must be removed by using suitable electronic-grade vapor-cleaning solvents to eliminate contamination that could cause electrolytic surface corrosion. Good results can be obtained by using ultrasonic cleaning of the solvent. The choice of the proper system is depends upon many factors such as component mix, flux, and solder paste and assembly method. The ability of the cleaning system to remove flux residues and contamination from under the chips is very important.

❑ **Constructions**

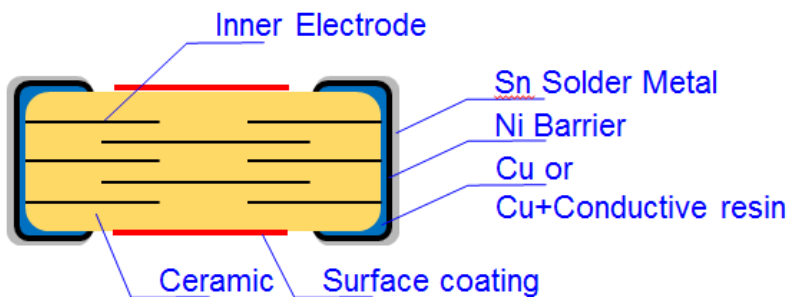

FOOTPRINT DIMENSIONS

Size Inch (mm)	Item	Dimension (mm)	Fig. 5 Illustration of Footprint
1808(4520)	D1	6.40~7.50	<p>Dimensions in millimeters</p>
	D2	1.45~1.75	
	D3	3.50~4.00	
	D4	1.45~1.75	
	D5	1.80~2.00	
1812(4532)	D1	6.40~7.50	
	D2	1.45~1.75	
	D3	3.50~4.00	
	D4	1.45~1.75	
	D5	2.50~2.80	
2211(5728)	D1	7.80	
	D2	1.75	
	D3	4.30	
	D4	1.75	
	D5	2.50	
2220(5750)	D1	7.80	
	D2	1.75	
	D3	4.30	
	D4	1.75	
	D5	4.60	

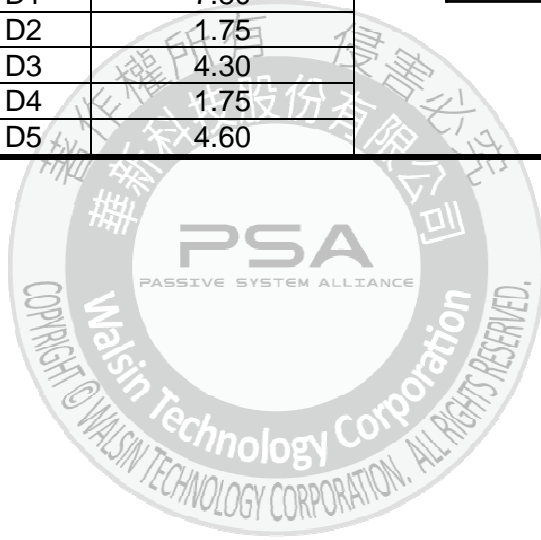

Looking for pricing, stock, or lifecycle information?

Click below to explore more details on WIN SOURCE:

- ⊖ [View S242B681K502CT](#) on WIN SOURCE
- ⊖ [Walsin Technology Corporation](#) Information

Optimize Your Supply Chain with WIN SOURCE Solutions

- ✓ Global Sourcing Solution
- ✓ Obsolete Management
- ✓ Cost Control Management
- ✓ Shortage Management
- ✓ Alternative Solution
- ✓ Excess Inventory Management