



**THE DATASHEET OF
XF3M-6015-1B**



XF3M

For FPC/FFC

Rotary Backlock Connector (0.5-mm Pitch, 1.0-mm Pitch, Dual sided, Upper sided Contact)

Rotary Backlock Connectors Provide Improved Insertion of FPC/FFC Cables and helps Confirm Proper Connection with Sure Lock Feel.

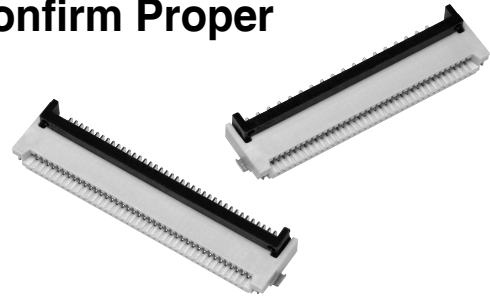

- Models available with 0.5-mm or 1.0-mm pitch.
- Models available with dual-sided contacts or upper sided. (Models with upper sided come only with a 0.5-mm pitch.)
- Models available with gold or Tin-plated. (Tin-plated is available only with models with dual-sided contacts.)
- Models with 80 pins (multiple type) available with 0.5-mm pitch.
- Applicable FPC/FFC thickness of 0.3 mm.
- Halogen Free (*)

* OMRON uses the following standard to determine halogen-free construction: 900 ppm max. for Br, 900 ppm max. for Cl, and 1,500 ppm max. for Br+Cl.

RoHS compliant

■ Ratings and Specifications

Rated current	0.5 A AC/DC
Rated voltage	50 V AC/DC
Contact resistance	50 mΩ max. (at 20 mV DC max., 100 mA max.)
Insulation resistance	100 MΩ min. (at 250 V DC)
Dielectric strength	250 V AC for 1 min. (leakage current: 1 mA max.)
Insertion durability	Gold-plated: 20 times Tin-plated: 10 times
Ambient operating temperature	-30 to 85 °C (With no icing or condensation)

■ Materials and Finish

Model	Dual-sided Contact Models		Upper sided Models
	Gold-plated	Tin-plated	Gold-plated
Housing	LCP resin (UL94 V-0)/natural		LCP resin (UL94 V-0)/gray
Slider	LCP resin (UL94 V-0)/black		
Contacts	Spring copper alloy/nickel substrate (1.5 μm)		
	Gold-plated contacts (flash)	Tin-plated contacts (1 μm)	Gold-plated contacts (flash)
Hold-down	Copper alloy/tin-plated (1 μm)		

■ Models

Contact type Pitch	Dual-sided contact		Upper sided	
	Contacts	Model	Contacts	Model
0.5 mm	Gold-plated (flash)	XF3M-□□15-1B□	Gold-plated (flash)	XF3M-□□25-1B
	Tin-plated	XF3M-□□15-1D		
1.0 mm	Gold-plated (flash)	XF3M(1)-□□15-1B		
	Tin-plated	XF3M(1)-□□15-1D		

XF3M

XF3M Rotary Backlock Connector (0.5-mm Pitch, 1.0-mm Pitch, Dual sided, Upper sided Contact)

XF3M 0.5-mm pitch model

■ Dimensions

(Unit: mm)

XF3M-□□15-1B
 XF3M-□□15-1BE
 XF3M-□□15-1D
 XF3M-□□25-1B

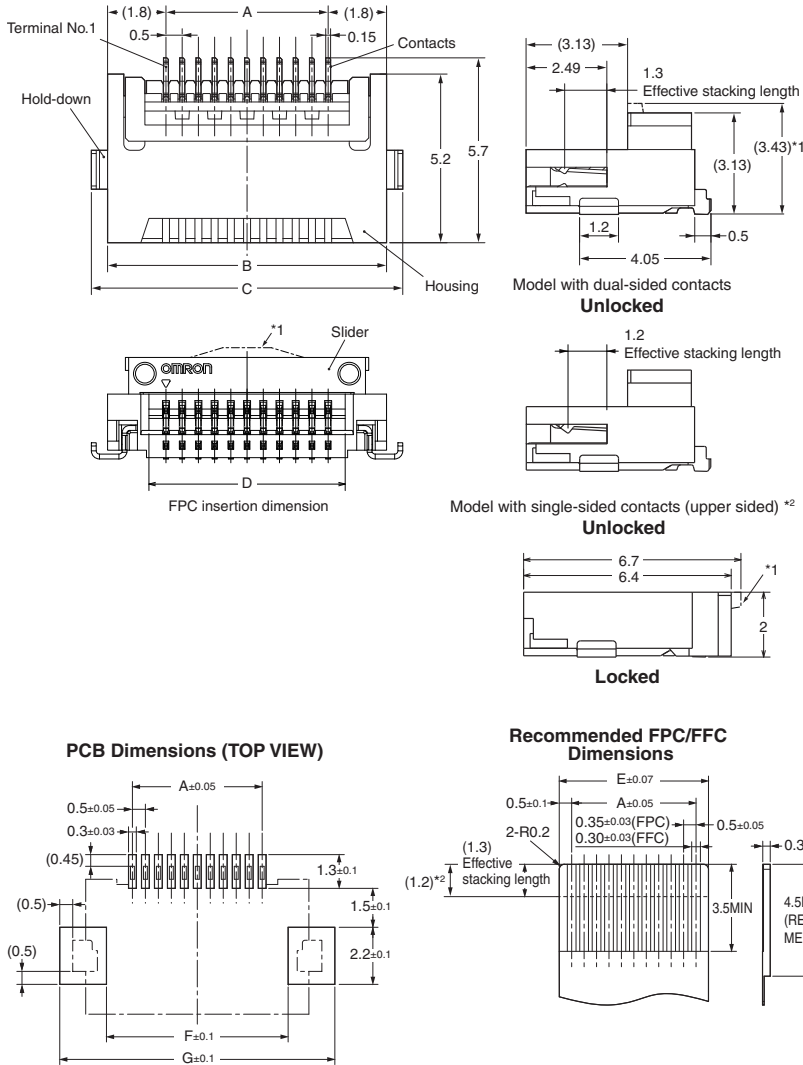

Table of Dimension

Pins ^{*1}	A	B	C	D	E	F	G
4	1.5	5.1	6.1	2.55	2.5	3.5	7.1
5	2.0	5.6	6.6	3.05	3.0	4.0	7.6
6	2.5	6.1	7.1	3.55	3.5	4.5	8.1
7	3.0	6.6	7.6	4.05	4.0	5.0	8.6
8	3.5	7.1	8.1	4.55	4.5	5.5	9.1
9	4.0	7.6	8.6	5.05	5.0	6.0	9.6
10	4.5	8.1	9.1	5.55	5.5	6.5	10.1
11	5.0	8.6	9.6	6.05	6.0	7.0	10.6
12	5.5	9.1	10.1	6.55	6.5	7.5	11.1
13	6.0	9.6	10.6	7.05	7.0	8.0	11.6
14	6.5	10.1	11.1	7.55	7.5	8.5	12.1
15	7.0	10.6	11.6	8.05	8.0	9.0	12.6
16	7.5	11.1	12.1	8.55	8.5	9.5	13.1
17	8.0	11.6	12.6	9.05	9.0	10.0	13.6
18	8.5	12.1	13.1	9.55	9.5	10.5	14.1
19	9.0	12.6	13.6	10.05	10.0	11.0	14.6
20	9.5	13.1	14.1	10.55	10.5	11.5	15.1
21	10.0	13.6	14.6	11.05	11.0	12.0	15.6
22	10.5	14.1	15.1	11.55	11.5	12.5	16.1
23	11.0	14.6	15.6	12.05	12.0	13.0	16.6
24	11.5	15.1	16.1	12.55	12.5	13.5	17.1
25	12.0	15.6	16.6	13.05	13.0	14.0	17.6
26	12.5	16.1	17.1	13.55	13.5	14.5	18.1
28	13.5	17.1	18.1	14.55	14.5	15.5	19.1
29	14.0	17.6	18.6	15.05	15.0	16.0	19.6
30	14.5	18.1	19.1	15.55	15.5	16.5	20.1
31	15.0	18.6	19.6	16.05	16.0	17.0	20.6
32	15.5	19.1	20.1	16.55	16.5	17.5	21.1
33	16.0	19.6	20.6	17.05	17.0	18.0	21.6
34	16.5	20.1	21.1	17.55	17.5	18.5	22.1
35	17.0	20.6	21.6	18.05	18.0	19.0	22.6
36	17.5	21.1	22.1	18.55	18.5	19.5	23.1
37	18.0	21.6	22.6	19.05	19.0	20.0	23.6
38	18.5	22.1	23.1	19.55	19.5	20.5	24.1
40	19.5	23.1	24.1	20.55	20.5	21.5	25.1
41	20.0	23.6	24.6	21.05	21.0	22.0	25.6
42	20.5	24.1	25.1	21.55	21.5	22.5	26.1
45	22.0	25.6	26.6	23.05	23.0	24.0	27.6
50	24.5	28.1	29.1	25.55	25.5	26.5	30.1
51	25.0	28.6	29.6	26.05	26.0	27.0	30.6
53	26.0	29.6	30.6	27.05	27.0	28.0	31.6
54	26.5	30.1	31.1	27.55	27.5	28.5	32.1
55	27.0	30.6	31.6	28.05	28.0	29.0	32.6
57	28.0	31.6	32.6	29.05	29.0	30.0	33.6
60	29.5	33.1	34.1	30.55	30.5	31.5	35.1
80	39.5	43.1	44.1	40.55	40.5	41.5	45.1

*1. Dotted lines indicate the shape and dimensions of the XF3M-8015-1BE Connectors.
 *2. For the XF3M-□□25-1B Connectors.

■ Ordering Information

● Dual-sided Contact Models - Gold-plated (flash)

1500pcs per reel

Pins ^{*1}	Model	Pins ^{*1}	Model	Pins ^{*1}	Model	Pins ^{*1}	Model	Quantity per reel (unit) ^{*2}
4	XF3M-0415-1B	16	XF3M-1615-1B	29	XF3M-2915-1B	42	XF3M-4215-1B	1,500
5	XF3M-0515-1B	17	XF3M-1715-1B	30	XF3M-3015-1B	45	XF3M-4515-1B	
6	XF3M-0615-1B	18	XF3M-1815-1B	31	XF3M-3115-1B	50	XF3M-5015-1B	
7	XF3M-0715-1B	19	XF3M-1915-1B	32	XF3M-3215-1B	51	XF3M-5115-1B	
8	XF3M-0815-1B	20	XF3M-2015-1B	33	XF3M-3315-1B	53	XF3M-5315-1B	
9	XF3M-0915-1B	21	XF3M-2115-1B	34	XF3M-3415-1B	54	XF3M-5415-1B	
10	XF3M-1015-1B	22	XF3M-2215-1B	35	XF3M-3515-1B	55	XF3M-5515-1B	
11	XF3M-1115-1B	23	XF3M-2315-1B	36	XF3M-3615-1B	57	XF3M-5715-1B	
12	XF3M-1215-1B	24	XF3M-2415-1B	37	XF3M-3715-1B	60	XF3M-6015-1B	
13	XF3M-1315-1B	25	XF3M-2515-1B	38	XF3M-3815-1B			
14	XF3M-1415-1B	26	XF3M-2615-1B	40	XF3M-4015-1B			
15	XF3M-1515-1B	28	XF3M-2815-1B	41	XF3M-4115-1B			

1000pcs per reel

Pins ^{*1}	Model	Quantity per reel (unit) ^{*2}
80	XF3M-8015-1BE	1,000

XF3M

XF3M Rotary Backlock Connector (0.5-mm Pitch, 1.0-mm Pitch, Dual sided, Upper sided Contact)

100pcs per reel

Pins ^{*1}	Model	Pins ^{*1}	Model	Pins ^{*1}	Model	Pins ^{*1}	Model	Quantity per reel (unit) ^{*2}
4	XF3M-0415-1B-R100	16	XF3M-1615-1B-R100	29	XF3M-2915-1B-R100	42	XF3M-4215-1B-R100	100
5	XF3M-0515-1B-R100	17	XF3M-1715-1B-R100	30	XF3M-3015-1B-R100	45	XF3M-4515-1B-R100	
6	XF3M-0615-1B-R100	18	XF3M-1815-1B-R100	31	XF3M-3115-1B-R100	50	XF3M-5015-1B-R100	
7	XF3M-0715-1B-R100	19	XF3M-1915-1B-R100	32	XF3M-3215-1B-R100	51	XF3M-5115-1B-R100	
8	XF3M-0815-1B-R100	20	XF3M-2015-1B-R100	33	XF3M-3315-1B-R100	53	XF3M-5315-1B-R100	
9	XF3M-0915-1B-R100	21	XF3M-2115-1B-R100	34	XF3M-3415-1B-R100	54	XF3M-5415-1B-R100	
10	XF3M-1015-1B-R100	22	XF3M-2215-1B-R100	35	XF3M-3515-1B-R100	55	XF3M-5515-1B-R100	
11	XF3M-1115-1B-R100	23	XF3M-2315-1B-R100	36	XF3M-3615-1B-R100	57	XF3M-5715-1B-R100	
12	XF3M-1215-1B-R100	24	XF3M-2415-1B-R100	37	XF3M-3715-1B-R100	60	XF3M-6015-1B-R100	
13	XF3M-1315-1B-R100	25	XF3M-2515-1B-R100	38	XF3M-3815-1B-R100	80	XF3M-8015-1BE-R100	
14	XF3M-1415-1B-R100	26	XF3M-2615-1B-R100	40	XF3M-4015-1B-R100			
15	XF3M-1515-1B-R100	28	XF3M-2815-1B-R100	41	XF3M-4115-1B-R100			

● Dual-sided Contact Models - Tin-plated

1500pcs per reel

Pins ^{*1}	Model	Pins ^{*1}	Model	Pins ^{*1}	Model	Pins ^{*1}	Model	Quantity per reel (unit) ^{*2}
(4)	XF3M-0415-1D	(14)	XF3M-1415-1D	(24)	XF3M-2415-1D	(35)	XF3M-3515-1D	1,500
(5)	XF3M-0515-1D	(15)	XF3M-1515-1D	(25)	XF3M-2515-1D	(36)	XF3M-3615-1D	
(6)	XF3M-0615-1D	(16)	XF3M-1615-1D	(26)	XF3M-2615-1D	(37)	XF3M-3715-1D	
(7)	XF3M-0715-1D	(17)	XF3M-1715-1D	(28)	XF3M-2815-1D	(38)	XF3M-3815-1D	
(8)	XF3M-0815-1D	(18)	XF3M-1815-1D	(29)	XF3M-2915-1D	(40)	XF3M-4015-1D	
(9)	XF3M-0915-1D	(19)	XF3M-1915-1D	(30)	XF3M-3015-1D	(41)	XF3M-4115-1D	
10	XF3M-1015-1D	(20)	XF3M-2015-1D	(31)	XF3M-3115-1D	(42)	XF3M-4215-1D	
(11)	XF3M-1115-1D	(21)	XF3M-2115-1D	(32)	XF3M-3215-1D	(45)	XF3M-4515-1D	
(12)	XF3M-1215-1D	(22)	XF3M-2215-1D	(33)	XF3M-3315-1D	(50)	XF3M-5015-1D	
(13)	XF3M-1315-1D	(23)	XF3M-2315-1D	(34)	XF3M-3415-1D			

100pcs per reel

Pins ^{*1}	Model	Pins ^{*1}	Model	Pins ^{*1}	Model	Pins ^{*1}	Model	Quantity per reel (unit) ^{*2}
(4)	XF3M-0415-1D-R100	(14)	XF3M-1415-1D-R100	(24)	XF3M-2415-1D-R100	(35)	XF3M-3515-1D-R100	100
(5)	XF3M-0515-1D-R100	(15)	XF3M-1515-1D-R100	(25)	XF3M-2515-1D-R100	(36)	XF3M-3615-1D-R100	
(6)	XF3M-0615-1D-R100	(16)	XF3M-1615-1D-R100	(26)	XF3M-2615-1D-R100	(37)	XF3M-3715-1D-R100	
(7)	XF3M-0715-1D-R100	(17)	XF3M-1715-1D-R100	(28)	XF3M-2815-1D-R100	(38)	XF3M-3815-1D-R100	
(8)	XF3M-0815-1D-R100	(18)	XF3M-1815-1D-R100	(29)	XF3M-2915-1D-R100	(40)	XF3M-4015-1D-R100	
(9)	XF3M-0915-1D-R100	(19)	XF3M-1915-1D-R100	(30)	XF3M-3015-1D-R100	(41)	XF3M-4115-1D-R100	
10	XF3M-1015-1D-R100	(20)	XF3M-2015-1D-R100	(31)	XF3M-3115-1D-R100	(42)	XF3M-4215-1D-R100	
(11)	XF3M-1115-1D-R100	(21)	XF3M-2115-1D-R100	(32)	XF3M-3215-1D-R100	(45)	XF3M-4515-1D-R100	
(12)	XF3M-1215-1D-R100	(22)	XF3M-2215-1D-R100	(33)	XF3M-3315-1D-R100	(50)	XF3M-5015-1D-R100	
(13)	XF3M-1315-1D-R100	(23)	XF3M-2315-1D-R100	(34)	XF3M-3415-1D-R100			

● Upper-sided Models - Gold-plated (flash)

1500pcs per reel

Pins ^{*1}	Model	Pins ^{*1}	Model	Pins ^{*1}	Model	Pins ^{*1}	Model	Quantity per reel (unit) ^{*2}
(4)	XF3M-0425-1B	13	XF3M-1325-1B	22	XF3M-2225-1B	(32)	XF3M-3225-1B	1,500
(5)	XF3M-0525-1B	14	XF3M-1425-1B	(23)	XF3M-2325-1B	(33)	XF3M-3325-1B	
(6)	XF3M-0625-1B	(15)	XF3M-1525-1B	24	XF3M-2425-1B	(34)	XF3M-3425-1B	
7	XF3M-0725-1B	16	XF3M-1625-1B	(25)	XF3M-2525-1B	(35)	XF3M-3525-1B	
8	XF3M-0825-1B	(17)	XF3M-1725-1B	26	XF3M-2625-1B	(36)	XF3M-3625-1B	
9	XF3M-0925-1B	18	XF3M-1825-1B	(28)	XF3M-2825-1B	(37)	XF3M-3725-1B	
10	XF3M-1025-1B	(19)	XF3M-1925-1B	(29)	XF3M-2925-1B	(38)	XF3M-3825-1B	
(11)	XF3M-1125-1B	20	XF3M-2025-1B	(30)	XF3M-3025-1B	40	XF3M-4025-1B	
12	XF3M-1225-1B	(21)	XF3M-2125-1B	(31)	XF3M-3125-1B			

100pcs per reel

Pins ^{*1}	Model	Pins ^{*1}	Model	Pins ^{*1}	Model	Pins ^{*1}	Model	Quantity per reel (unit) ^{*2}
(4)	XF3M-0425-1B-R100	(13)	XF3M-1325-1B-R100	(22)	XF3M-2225-1B-R100	(32)	XF3M-3225-1B-R100	100
(5)	XF3M-0525-1B-R100	(14)	XF3M-1425-1B-R100	(23)	XF3M-2325-1B-R100	(33)	XF3M-3325-1B-R100	
(6)	XF3M-0625-1B-R100	(15)	XF3M-1525-1B-R100	(24)	XF3M-2425-1B-R100	(34)	XF3M-3425-1B-R100	
(7)	XF3M-0725-1B-R100	(16)	XF3M-1625-1B-R100	(25)	XF3M-2525-1B-R100	(35)	XF3M-3525-1B-R100	
(8)	XF3M-0825-1B-R100	(17)	XF3M-1725-1B-R100	(26)	XF3M-2625-1B-R100	(36)	XF3M-3625-1B-R100	
(9)	XF3M-0925-1B-R100	18	XF3M-1825-1B-R100	(28)	XF3M-2825-1B-R100	(37)	XF3M-3725-1B-R100	
(10)	XF3M-1025-1B-R100	(19)	XF3M-1925-1B-R100	(29)	XF3M-2925-1B-R100	(38)	XF3M-3825-1B-R100	
(11)	XF3M-1125-1B-R100	(20)	XF3M-2025-1B-R100	(30)	XF3M-3025-1B-R100	(40)	XF3M-4025-1B-R100	
(12)	XF3M-1225-1B-R100	(21)	XF3M-2125-1B-R100	(31)	XF3M-3125-1B-R100			

*1. Please consult your OMRON representative for available pin count.
Please consult your OMRON representative for the marketing dates for pin counts in parentheses.
*2. Please order by integer multiple of the quantity per reel.

XF3M

XF3M Rotary Backlock Connector (0.5-mm Pitch, 1.0-mm Pitch, Dual sided, Upper sided Contact)

XF3M(1) 1.0-mm pitch model

■ Dimensions

(Unit: mm)

XF3M(1)-□□15-1B

XF3M(1)-□□15-1D

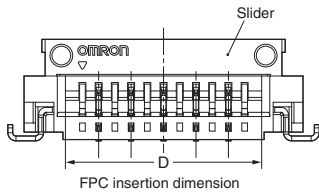
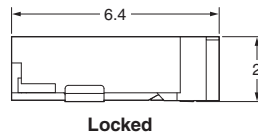
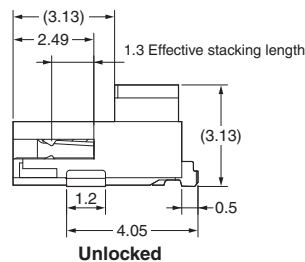
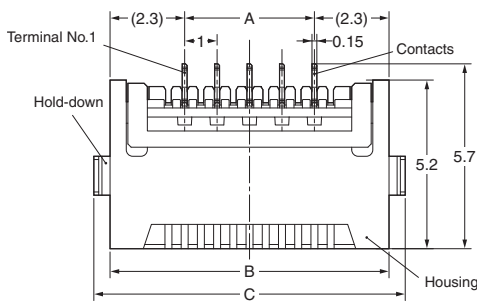

PCB Dimensions (TOP VIEW)

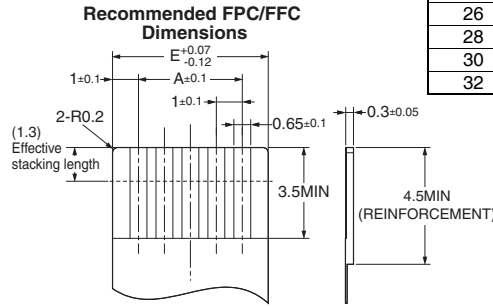
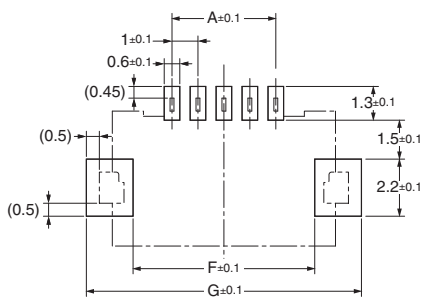

Table of Dimensions

Pins*1	A	B	C	D	E	F	G
4	3.0	7.6	8.6	5.05	5.0	6.0	9.6
5	4.0	8.6	9.6	6.05	6.0	7.0	10.6
6	5.0	9.6	10.6	7.05	7.0	8.0	11.6
7	6.0	10.6	11.6	8.05	8.0	9.0	12.6
8	7.0	11.6	12.6	9.05	9.0	10.0	13.6
9	8.0	12.6	13.6	10.05	10.0	11.0	14.6
10	9.0	13.6	14.6	11.05	11.0	12.0	15.6
11	10.0	14.6	15.6	12.05	12.0	13.0	16.6
12	11.0	15.6	16.6	13.05	13.0	14.0	17.6
14	13.0	17.6	18.6	15.05	15.0	16.0	19.6
15	14.0	18.6	19.6	16.05	16.0	17.0	20.6
16	15.0	19.6	20.6	17.05	17.0	18.0	21.6
17	16.0	20.6	21.6	18.05	18.0	19.0	22.6
18	17.0	21.6	22.6	19.05	19.0	20.0	23.6
20	19.0	23.6	24.6	21.05	21.0	22.0	25.6
22	21.0	25.6	26.6	23.05	23.0	24.0	27.6
23	22.0	26.6	27.6	24.05	24.0	25.0	28.6
24	23.0	27.6	28.6	25.05	25.0	26.0	29.6
25	24.0	28.6	29.6	26.05	26.0	27.0	30.6
26	25.0	29.6	30.6	27.05	27.0	28.0	31.6
28	27.0	31.6	32.6	29.05	29.0	30.0	33.6
30	29.0	33.6	34.6	31.05	31.0	32.0	35.6
32	31.0	35.6	36.6	33.05	33.0	34.0	37.6

■ Ordering Information

● Dual-sided Contact Models - Gold-plated (flash)

1500pcs per reel

Pins*1	Model	Pins*1	Model	Pins*1	Model	Pins*1	Model	Quantity per reel (unit) *2
4	XF3M(1)-0415-1B	10	XF3M(1)-1015-1B	(17)	XF3M(1)-1715-1B	25	XF3M(1)-2515-1B	1,500
5	XF3M(1)-0515-1B	11	XF3M(1)-1115-1B	18	XF3M(1)-1815-1B	26	XF3M(1)-2615-1B	
6	XF3M(1)-0615-1B	12	XF3M(1)-1215-1B	20	XF3M(1)-2015-1B	28	XF3M(1)-2815-1B	
7	XF3M(1)-0715-1B	14	XF3M(1)-1415-1B	22	XF3M(1)-2215-1B	30	XF3M(1)-3015-1B	
8	XF3M(1)-0815-1B	15	XF3M(1)-1515-1B	23	XF3M(1)-2315-1B	32	XF3M(1)-3215-1B	
9	XF3M(1)-0915-1B	16	XF3M(1)-1615-1B	(24)	XF3M(1)-2415-1B			

100pcs per reel

Pins*1	Model	Pins*1	Model	Pins*1	Model	Pins*1	Model	Quantity per reel (unit) *2
4	XF3M(1)-0415-1B-R100	10	XF3M(1)-1015-1B-R100	(17)	XF3M(1)-1715-1B-R100	(25)	XF3M(1)-2515-1B-R100	100
5	XF3M(1)-0515-1B-R100	11	XF3M(1)-1115-1B-R100	18	XF3M(1)-1815-1B-R100	26	XF3M(1)-2615-1B-R100	
6	XF3M(1)-0615-1B-R100	12	XF3M(1)-1215-1B-R100	20	XF3M(1)-2015-1B-R100	(28)	XF3M(1)-2815-1B-R100	
7	XF3M(1)-0715-1B-R100	14	XF3M(1)-1415-1B-R100	22	XF3M(1)-2215-1B-R100	30	XF3M(1)-3015-1B-R100	
8	XF3M(1)-0815-1B-R100	15	XF3M(1)-1515-1B-R100	23	XF3M(1)-2315-1B-R100	(32)	XF3M(1)-3215-1B-R100	
9	XF3M(1)-0915-1B-R100	16	XF3M(1)-1615-1B-R100	(24)	XF3M(1)-2415-1B-R100			

● Dual-sided Contact Models - Tin-plated

1500pcs per reel

Pins*1	Model	Pins*1	Model	Pins*1	Model	Pins*1	Model	Quantity per reel (unit) *2
(4)	XF3M(1)-0415-1D	10	XF3M(1)-1015-1D	(17)	XF3M(1)-1715-1D	(25)	XF3M(1)-2515-1D	1,500
(5)	XF3M(1)-0515-1D	(11)	XF3M(1)-1115-1D	18	XF3M(1)-1815-1D	(26)	XF3M(1)-2615-1D	
(6)	XF3M(1)-0615-1D	12	XF3M(1)-1215-1D	20	XF3M(1)-2015-1D	(28)	XF3M(1)-2815-1D	
(7)	XF3M(1)-0715-1D	(14)	XF3M(1)-1415-1D	22	XF3M(1)-2215-1D	(30)	XF3M(1)-3015-1D	
(8)	XF3M(1)-0815-1D	(15)	XF3M(1)-1515-1D	(23)	XF3M(1)-2315-1D	(32)	XF3M(1)-3215-1D	
(9)	XF3M(1)-0915-1D	(16)	XF3M(1)-1615-1D	(24)	XF3M(1)-2415-1D			



100pcs per reel

Pins*1	Model	Pins*1	Model	Pins*1	Model	Pins*1	Model	Quantity per reel (unit) *2
(4)	XF3M(1)-0415-1D-R100	10	XF3M(1)-1015-1D-R100	(17)	XF3M(1)-1715-1D-R100	(25)	XF3M(1)-2515-1D-R100	100
(5)	XF3M(1)-0515-1D-R100	(11)	XF3M(1)-1115-1D-R100	(18)	XF3M(1)-1815-1D-R100	(26)	XF3M(1)-2615-1D-R100	
(6)	XF3M(1)-0615-1D-R100	(12)	XF3M(1)-1215-1D-R100	(20)	XF3M(1)-2015-1D-R100	(28)	XF3M(1)-2815-1D-R100	
(7)	XF3M(1)-0715-1D-R100	(14)	XF3M(1)-1415-1D-R100	(22)	XF3M(1)-2215-1D-R100	(30)	XF3M(1)-3015-1D-R100	
(8)	XF3M(1)-0815-1D-R100	(15)	XF3M(1)-1515-1D-R100	(23)	XF3M(1)-2315-1D-R100	(32)	XF3M(1)-3215-1D-R100	
(9)	XF3M(1)-0915-1D-R100	(16)	XF3M(1)-1615-1D-R100	(24)	XF3M(1)-2415-1D-R100			

*1. Please consult your OMRON representative for available pin count.
Please consult your OMRON representative for the marketing dates for pin counts in parentheses.
*2. Please order by integer multiple of the quantity per reel.

Looking for pricing, stock, or lifecycle information?

Click below to explore more details on WIN SOURCE:

-  [View XF3M-6015-1B on WIN SOURCE](#)
-  [Omron Information](#)

Optimize Your Supply Chain with WIN SOURCE Solutions

-  Global Sourcing Solution
-  Obsolete Management
-  Cost Control Management
-  Shortage Management
-  Alternative Solution
-  Excess Inventory Management