



# THE DATASHEET OF NRVS2D



Thank you for your interest in **onsemi** products.  
Your technical document begins on the following pages.



## Your Feedback is Important to Us!

Please take a moment to participate in our short survey.  
At **onsemi**, we are dedicated to delivering technical content that best meets your needs.

### [Help Us Improve – Take the Survey](#)

This survey is intended to collect your feedback, capture any issues you may encounter, and to provide improvements you would like to suggest.

**We look forward to your feedback.**

To learn more about **onsemi**, please visit our website at  
[www.onsemi.com](http://www.onsemi.com)

**onsemi** and **onsemi** and other names, marks, and brands are registered and/or common law trademarks of Semiconductor Components Industries, LLC dba "**onsemi**" or its affiliates and/or subsidiaries in the United States and/or other countries. **onsemi** owns the rights to a number of patents, trademarks, copyrights, trade secrets, and other intellectual property. A listing of **onsemi** product/patent coverage may be accessed at [www.onsemi.com/site/pdf/Patent-Marking.pdf](http://www.onsemi.com/site/pdf/Patent-Marking.pdf). **onsemi** reserves the right to make changes at any time to any products or information herein, without notice. The information herein is provided "as-is" and **onsemi** makes no warranty, representation or guarantee regarding the accuracy of the information, product features, availability, functionality, or suitability of its products for any particular purpose, nor does **onsemi** assume any liability arising out of the application or use of any product or circuit, and specifically disclaims any and all liability, including without limitation special, consequential or incidental damages. Buyer is responsible for its products and applications using **onsemi** products, including compliance with all laws, regulations and safety requirements or standards, regardless of any support or applications information provided by **onsemi**. "Typical" parameters which may be provided in **onsemi** data sheets and/or specifications can and do vary in different applications and actual performance may vary over time. All operating parameters, including "Typicals" must be validated for each customer application by customer's technical experts. **onsemi** does not convey any license under any of its intellectual property rights nor the rights of others. **onsemi** products are not designed, intended, or authorized for use as a critical component in life support systems or any FDA Class 3 medical devices or medical devices with a same or similar classification in a foreign jurisdiction or any devices intended for implantation in the human body. Should Buyer purchase or use **onsemi** products for any such unintended or unauthorized application, Buyer shall indemnify and hold **onsemi** and its officers, employees, subsidiaries, affiliates, and distributors harmless against all claims, costs, damages, and expenses, and reasonable attorney fees arising out of, directly or indirectly, any claim of personal injury or death associated with such unintended or unauthorized use, even if such claim alleges that **onsemi** was negligent regarding the design or manufacture of the part. **onsemi** is an Equal Opportunity/Affirmative Action Employer. This literature is subject to all applicable copyright laws and is not for resale in any manner. Other names and brands may be claimed as the property of others.

# General-Purpose Rectifiers (Glass Passivated)

## S2A-S2M

### Description

The S2 family of devices are general-purpose 2 A rated rectifiers with voltage ratings ranging from 50 to 1000 V. They are implemented in traditional SMB packages and are well known to the industry. For advanced or special requirements, please contact an onsemi representative.

### Features

- High-Current Capability, 2 A Rated
- Fast Response:  $2 \mu\text{s } T_{rr}$
- Low-Forward Voltage Drop, 1.15 V  $V_F$  Max at 2 A
- High-Surge Current Capability, 50 A<sup>2</sup>s  $I_{FSM}$
- Glass Passivated Junction
- UL Certified, UL #E258596
- NRV Prefix for Automotive and Other Applications Requiring Unique Site and Control Change Requirements; AEC-Q101 Qualified and PPAP Capable
- These Devices are Pb-Free and are RoHS Compliant

### Applications

- Power Supplies
- AC to DC Rectification
- Bypass Diodes

### ABSOLUTE MAXIMUM RATINGS ( $T_A = 25^\circ\text{C}$ unless otherwise noted)

Symbol	Parameter	Value							Unit
		S2A	S2B	S2D	S2G	S2J	S2K	S2M	
$V_{RRM}$	Maximum Repetitive Reverse Voltage	50	100	200	400	600	800	1000	V
$I_{F(AV)}$	Average Rectified Forward Current at $T_A = 100^\circ\text{C}$	2.0							A
$I_{FSM}$	Non-Repetitive Peak Forward Surge Current 8.3 ms Single Half-Sine Wave	50							A
$T_{STG}$	Storage Temperature Range	-65 to +150							$^\circ\text{C}$
$T_J$	Operating Junction Temperature Range	-65 to +150							$^\circ\text{C}$

Stresses exceeding those listed in the Maximum Ratings table may damage the device. If any of these limits are exceeded, device functionality should not be assumed, damage may occur and reliability may be affected.

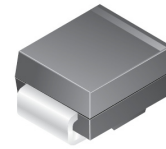

SMB  
CASE 403AF

### MARKING DIAGRAM

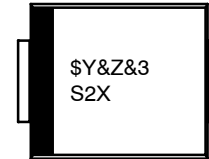

- \$Y = onsemi Logo
- &Z = Assembly Plant Code
- &3 = Numeric Date Code
- S2X = Specific Device Code
- X = A-M

### ORDERING INFORMATION

See detailed ordering and shipping information on page 2 of this data sheet.

NOTE: Some of the devices on this data sheet have been **DISCONTINUED**. Please refer to the table on page 2.

## S2A-S2M

### THERMAL CHARACTERISTICS ( $T_A = 25^\circ\text{C}$ unless otherwise noted)

Symbol	Parameter	Value	Unit
$P_D$	Power Dissipation	2.35	W
$R_{\theta JA}$	Thermal Resistance, Junction to Ambient (Note 1)	53	$^\circ\text{C}/\text{W}$

1. Device is mounted on FR-4 PCB 0.013 mm.

### ELECTRICAL CHARACTERISTICS ( $T_A = 25^\circ\text{C}$ unless otherwise noted)

Symbol	Parameter	Conditions	Value						Unit
			S2A	S2B	S2D	S2G	S2J	S2K	
$V_F$	Maximum Forward Voltage	$I_F = 2.0\text{ A}$	1.15						V
$t_{rr}$	Typical Reverse-Recovery Time	$I_F = 0.5\text{ A}, I_R = 1.0\text{ A}, I_{rr} = 0.25\text{ A}$	2.0						$\mu\text{s}$
$I_R$	Maximum Reverse Current at Rated $V_R$	$T_A = 25^\circ\text{C}$	1.0						$\mu\text{A}$
		$T_A = 125^\circ\text{C}$	125						
$C_T$	Typical Total Capacitance	$V_R = 4.0\text{ V}, f = 1.0\text{ MHz}$	30						pF

Product parametric performance is indicated in the Electrical Characteristics for the listed test conditions, unless otherwise noted. Product performance may not be indicated by the Electrical Characteristics if operated under different conditions.

### ORDERING INFORMATION

Part Number	Marking	Package	Shipping <sup>†</sup>
S2B, NRVS2B*	S2B	SMB (Pb-Free)	3000 / Tape & Reel
S2D, NRVS2D*	S2D		
S2M, NRVS2M*	S2M		

### DISCONTINUED (Note 2)

Part Number	Marking	Package	Shipping <sup>†</sup>
S2A, NRVS2A*	S2A	SMB (Pb-Free)	3000 / Tape & Reel
S2G, NRVS2G*	S2G		
S2J, NRVS2J*	S2J		
S2K, NRVS2K*	S2K		

<sup>†</sup>For information on tape and reel specifications, including part orientation and tape sizes, please refer to our Tape and Reel Packaging Specifications Brochure, BRD8011/D.

\*NRV Prefix for Automotive and Other Applications Requiring Unique Site and Control Change Requirements; AEC-Q101 Qualified and PPAP Capable.

2. **DISCONTINUED:** These devices are not recommended for new design. Please contact your **onsemi** representative for information. The most current information on these devices may be available on [www.onsemi.com](http://www.onsemi.com).

TYPICAL PERFORMANCE CHARACTERISTICS

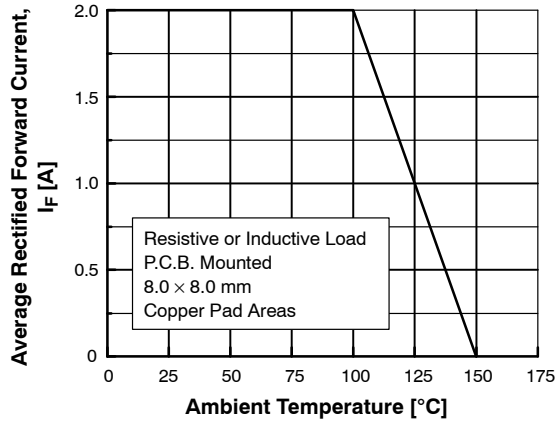

Figure 1. Forward Current Derating Curve

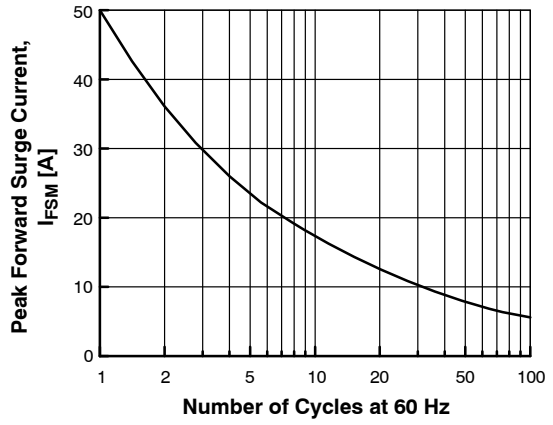

Figure 2. Non-Repetitive Surge Current

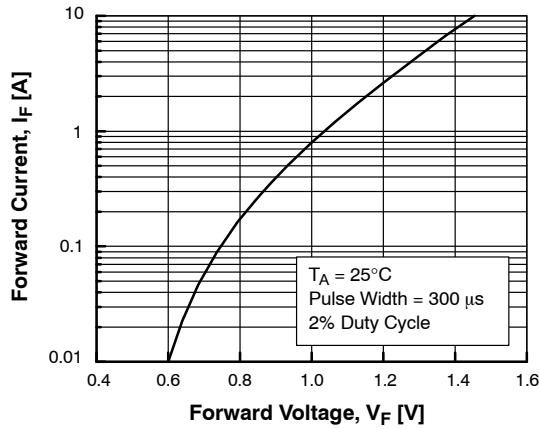

Figure 3. Forward Voltage Characteristics

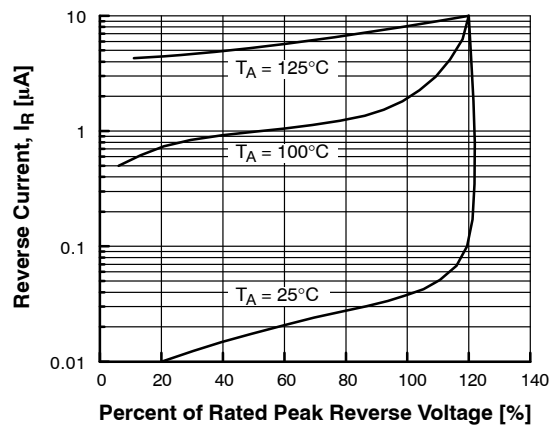

Figure 4. Reverse Current vs. Reverse Voltage

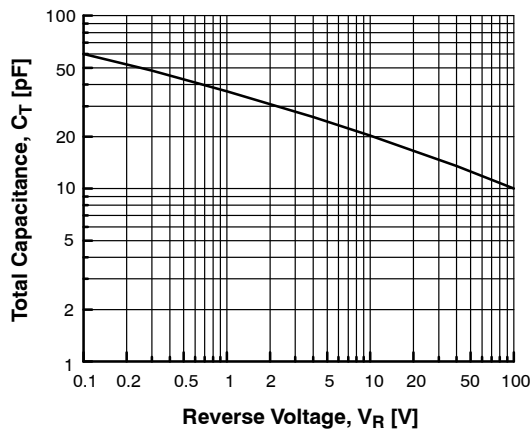

Figure 5. Total Capacitance

**MECHANICAL CASE OUTLINE**  
**PACKAGE DIMENSIONS**



**SMB**  
**CASE 403AF**  
**ISSUE O**

DATE 31 AUG 2016

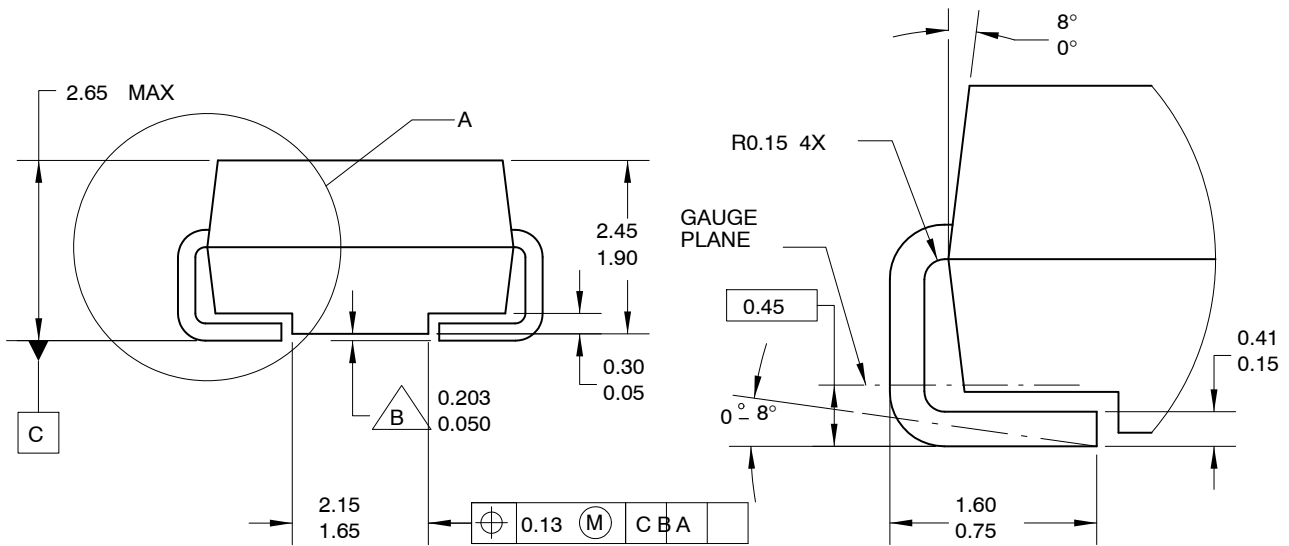
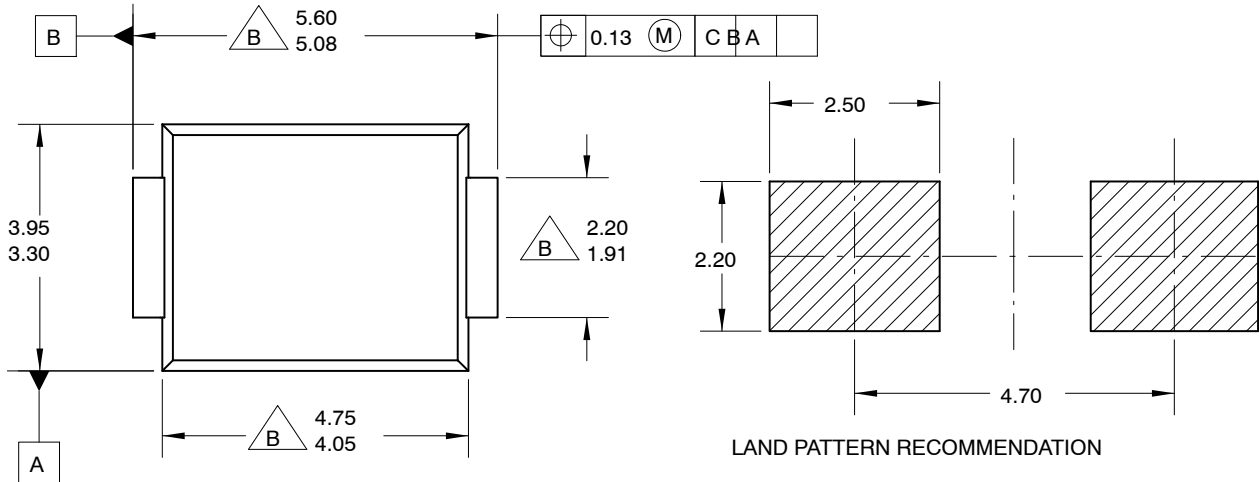

DETAIL A  
 SCALE 20 : 1

**NOTES:**

- A. EXCEPT WHERE NOTED CONFORMS TO JEDEC DO214 VARIATION AA.
- $\triangle$  B DOES NOT COMPLY JEDEC STD. VALUE.
- C. ALL DIMENSIONS ARE IN MILLIMETERS.
- D. DIMENSIONS ARE EXCLUSIVE OF BURRS, MOLD FLASH AND TIE BAR PROTRUSIONS.
- E. DIMENSION AND TOLERANCE AS PER ASME Y14.5-1994.
- F. LAND PATTERN STD. DIOM5336X240M.

<b>DOCUMENT NUMBER:</b>	<b>98AON13441G</b>	Electronic versions are uncontrolled except when accessed directly from the Document Repository. Printed versions are uncontrolled except when stamped "CONTROLLED COPY" in red.
<b>DESCRIPTION:</b>	<b>SMB</b>	<b>PAGE 1 OF 1</b>

onsemi and onsemi are trademarks of Semiconductor Components Industries, LLC dba onsemi or its subsidiaries in the United States and/or other countries. onsemi reserves the right to make changes without further notice to any products herein. onsemi makes no warranty, representation or guarantee regarding the suitability of its products for any particular purpose, nor does onsemi assume any liability arising out of the application or use of any product or circuit, and specifically disclaims any and all liability, including without limitation special, consequential or incidental damages. onsemi does not convey any license under its patent rights nor the rights of others.

**onsemi**, **Onsemi**, and other names, marks, and brands are registered and/or common law trademarks of Semiconductor Components Industries, LLC dba "**onsemi**" or its affiliates and/or subsidiaries in the United States and/or other countries. **onsemi** owns the rights to a number of patents, trademarks, copyrights, trade secrets, and other intellectual property. A listing of **onsemi**'s product/patent coverage may be accessed at [www.onsemi.com/site/pdf/Patent-Marking.pdf](http://www.onsemi.com/site/pdf/Patent-Marking.pdf). **onsemi** reserves the right to make changes at any time to any products or information herein, without notice. The information herein is provided "as-is" and **onsemi** makes no warranty, representation or guarantee regarding the accuracy of the information, product features, availability, functionality, or suitability of its products for any particular purpose, nor does **onsemi** assume any liability arising out of the application or use of any product or circuit, and specifically disclaims any and all liability, including without limitation special, consequential or incidental damages. Buyer is responsible for its products and applications using **onsemi** products, including compliance with all laws, regulations and safety requirements or standards, regardless of any support or applications information provided by **onsemi**. "Typical" parameters which may be provided in **onsemi** data sheets and/or specifications can and do vary in different applications and actual performance may vary over time. All operating parameters, including "Typicals" must be validated for each customer application by customer's technical experts. **onsemi** does not convey any license under any of its intellectual property rights nor the rights of others. **onsemi** products are not designed, intended, or authorized for use as a critical component in life support systems or any FDA Class 3 medical devices or medical devices with a same or similar classification in a foreign jurisdiction or any devices intended for implantation in the human body. Should Buyer purchase or use **onsemi** products for any such unintended or unauthorized application, Buyer shall indemnify and hold **onsemi** and its officers, employees, subsidiaries, affiliates, and distributors harmless against all claims, costs, damages, and expenses, and reasonable attorney fees arising out of, directly or indirectly, any claim of personal injury or death associated with such unintended or unauthorized use, even if such claim alleges that **onsemi** was negligent regarding the design or manufacture of the part. **onsemi** is an Equal Opportunity/Affirmative Action Employer. This literature is subject to all applicable copyright laws and is not for resale in any manner.

## ADDITIONAL INFORMATION

### TECHNICAL PUBLICATIONS:



Technical Library: [www.onsemi.com/design/resources/technical-documentation](http://www.onsemi.com/design/resources/technical-documentation)  
onsemi Website: [www.onsemi.com](http://www.onsemi.com)

### ONLINE SUPPORT: [www.onsemi.com/support](http://www.onsemi.com/support)

For additional information, please contact your local Sales Representative at [www.onsemi.com/support/sales](http://www.onsemi.com/support/sales)

## Looking for pricing, stock, or lifecycle information?

Click below to explore more details on WIN SOURCE:

-  [View NRVS2D on WIN SOURCE](#)
-  [ON Semiconductor](#) Information

## Optimize Your Supply Chain with WIN SOURCE Solutions

-  Global Sourcing Solution
-  Obsolete Management
-  Cost Control Management
-  Shortage Management
-  Alternative Solution
-  Excess Inventory Management