



**THE DATASHEET OF
VLMU35CT20-275-120**



UVC Emitting Diode in SMD Package



DESCRIPTION

VLMU35CT2.-275-120 are ceramic based mid power UVC LEDs with quartz window for long life time. The package size is 3.45 mm x 3.45 mm x 1.68 mm and the radiant power typically 26 mW at 180 mA in a wavelength range of 270 nm to 280 nm.

PRODUCT GROUP AND PACKAGE DATA

- Product group: LED
- Package: SMD ceramic
- Product series: mid power UV LED
- Angle of half intensity: $\pm 60^\circ$
- Lead-finishing: Au

FEATURES

- Ceramic SMT package with quartz window
- Dimension (L x W x H) in mm: 3.45 x 3.45 x 1.68
- DC forward current: up to 200 mA
- Radiant power (typ.): 18.2 mW at 120 mA and 26 mW at 180 mA
- Leads / terminations finish: gold plated (Au)
- Reflow soldering method
- MSL 3 according to J-STD-020
- Material categorization: for definitions of compliance please see www.vishay.com/doc?99912



APPLICATIONS

- Sterilization
- Medical application
- Sensing of gases, germs, DNA, ...

SAFETY ADVICES

These LEDs emit very strong UV radiation during operation. Do not look directly into the LED light when in operation as UV radiation can harm your eyes. To prevent inadequate exposure, wear protective eyewear. If LEDs are embedded in devices, please indicate warning labels. Avoid exposure to skin or other tissue during operation. Keep out of the reach of children. Take appropriate precautions around pets and other living organisms to avoid UV exposure.

PARTS TABLE

PART	COLOR	RADIANT POWER (mW)			at I _F (mA)	WAVELENGTH (nm)			at I _F (mA)	FORWARD VOLTAGE (V)			at I _F (mA)	TECHNOLOGY
		MIN.	TYP.	MAX.		MIN.	TYP.	MAX.		MIN.	TYP.	MAX.		
VLMU35CT20-275-120	Ultraviolet	20.5	26	-	180	270	274	280	180	5.0	6.3	7.0	180	AlGaIn
VLMU35CT21-275-120	Ultraviolet	22.5	26	-	180	270	274	280	180	5.0	6.3	7.0	180	AlGaIn

ABSOLUTE MAXIMUM RATINGS (T_{amb} = 25 °C, unless otherwise specified) VLMU35CT20-275-120, VLMU35CT21-275-120

PARAMETER	TEST CONDITION	SYMBOL	VALUE	UNIT
DC forward current		I _F	200	mA
Power dissipation		P _V	1.5	W
Reverse voltage			Not designed for reverse operation	
Electrostatic discharge	HBM: MIL-STD-883 C 3B	ESD	2000	V
Junction temperature		T _j	+105	°C
Operating temperature range		T _{amb}	-40 to +80	°C
Storage temperature range		T _{stg}	-40 to +100	°C
Solder temperature		T _{sol}	260	°C



OPTICAL AND ELECTRICAL CHARACTERISTICS ($T_{amb} = 25\text{ }^{\circ}\text{C}$, unless otherwise specified)
VLMU35CT20-275-120, VLMU35CT21-275-120, ULTRAVIOLET

PARAMETER	TEST CONDITION	PARTS	SYMBOL	MIN.	TYP.	MAX.	UNIT
Forward voltage	$I_F = 180\text{ mA}$	VLMU35CT20-275-120	V_F	5.0	6.3	7.0	V
		VLMU35CT21-275-120		5.0	6.3	7.0	
Radiant power	$I_F = 120\text{ mA}$		ϕ_e	-	18.2	-	mW
	$I_F = 180\text{ mA}$	VLMU35CT20-275-120		20.5	26	-	
		VLMU35CT21-275-120		22.5	26	-	
Ratio of radiant intensity / radiant power	$I_F = 180\text{ mA}$		I_e/ϕ_e	-	0.29	-	sr^{-1}
Peak wavelength	$I_F = 180\text{ mA}$		λ_p	270	274	280	nm
Angle of half intensity	$I_F = 180\text{ mA}$		φ	-	± 60	-	$^{\circ}$
Thermal resistance junction to solder-point	Soldered on 20 x 20 x 1.7 (in mm) Al MCPCB		R_{thJS}	-	17	-	K/W

Note

- Tolerances: $\pm 11\%$ for ϕ_e , $\pm 0.1\text{ V}$ for V_F , $\pm 3\text{ nm}$ for λ_p

RADIANT POWER CLASSIFICATION ($I_F = 180\text{ mA}$)

GROUP	ϕ_e (mW)		UNIT	CT20	CT21
	MIN.	MAX.			
P3	20.5	22.5	mW	x	-
P4	22.5	24.5		x	x
P5	24.5	26.5		x	x
P6	26.5	28.5		x	x
P7	28.5	-		x	x

PEAK WAVELENGTH CLASSIFICATION ($I_F = 180\text{ mA}$)

GROUP	λ_p (nm)		UNIT	CT20	CT21
	MIN.	MAX.			
W1	270	280	nm	x	x

FORWARD VOLTAGE CLASSIFICATION ($I_F = 180\text{ mA}$)

GROUP	V_F (V)		UNIT	CT20	CT21
	MIN.	MAX.			
VZ	5.0	5.5	V	x	x
V0	5.5	6.0		x	x
V1	6.0	6.5		x	x
V2	6.5	7.0		x	x

Note

- In order to ensure availability, single groups for radiant intensity, wavelength, and forward voltage will not be orderable. Only one group for radiant intensity, wavelength, and forward voltage will be shipped in any one reel

TYPICAL CHARACTERISTICS ($T_{amb} = 25\text{ }^{\circ}\text{C}$, unless otherwise specified)

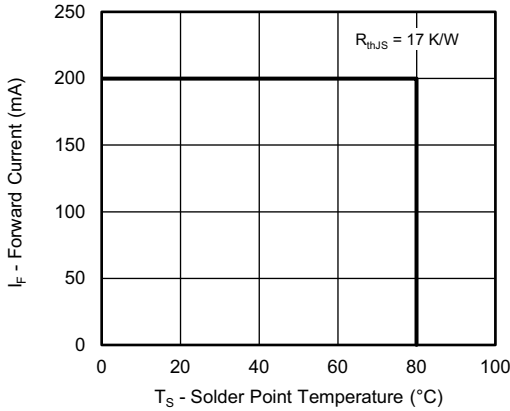

Fig. 1 - Maximum Forward Current vs. Solder Point Temperature

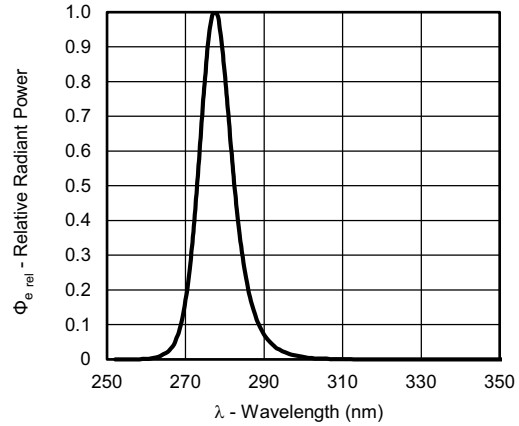

Fig. 4 - Relative Radiant Power vs. Wavelength

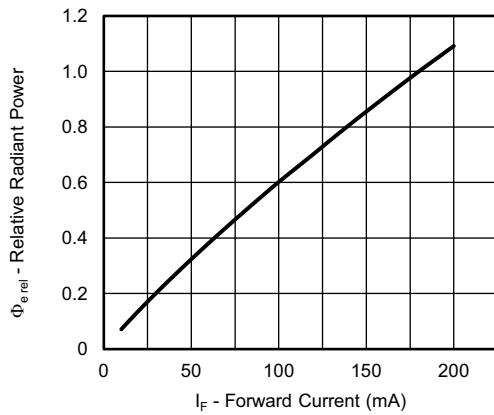

Fig. 2 - Relative Radiant Power vs. Forward Current

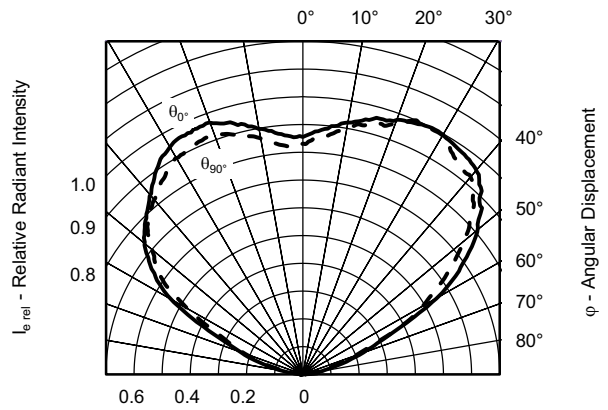

Fig. 5 - Relative Radiant Intensity vs. Angular Displacement

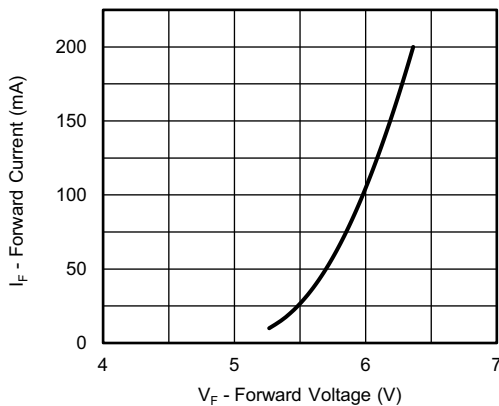

Fig. 3 - Forward Current vs. Forward Voltage

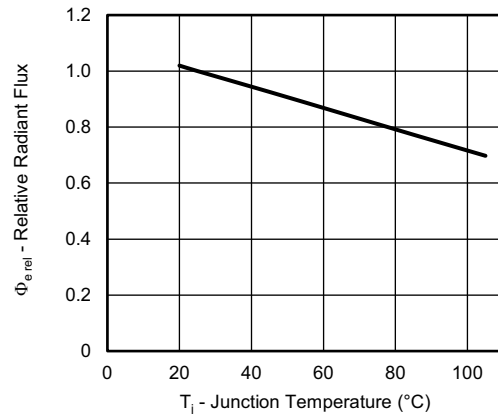

Fig. 6 - Relative Radiant Power vs. Junction Temperature

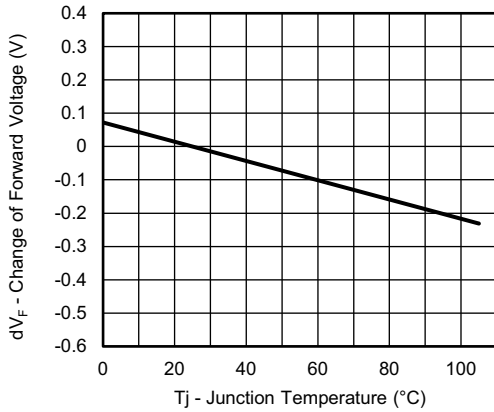
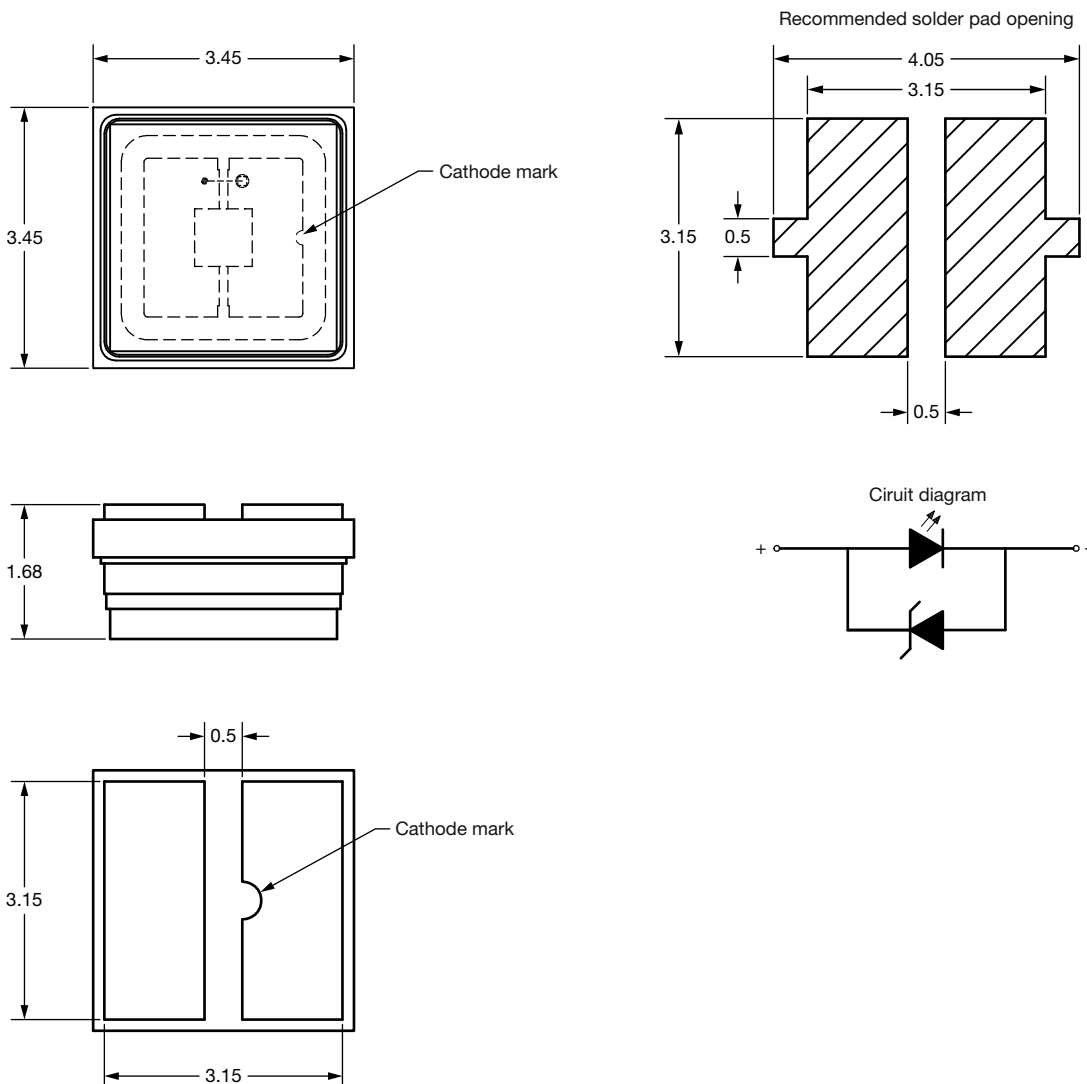

Fig. 7 - Change of Forward Voltage vs. Junction Temperature

PACKAGE DIMENSIONS in millimeters





TAPE AND REEL DIMENSIONS in millimeters

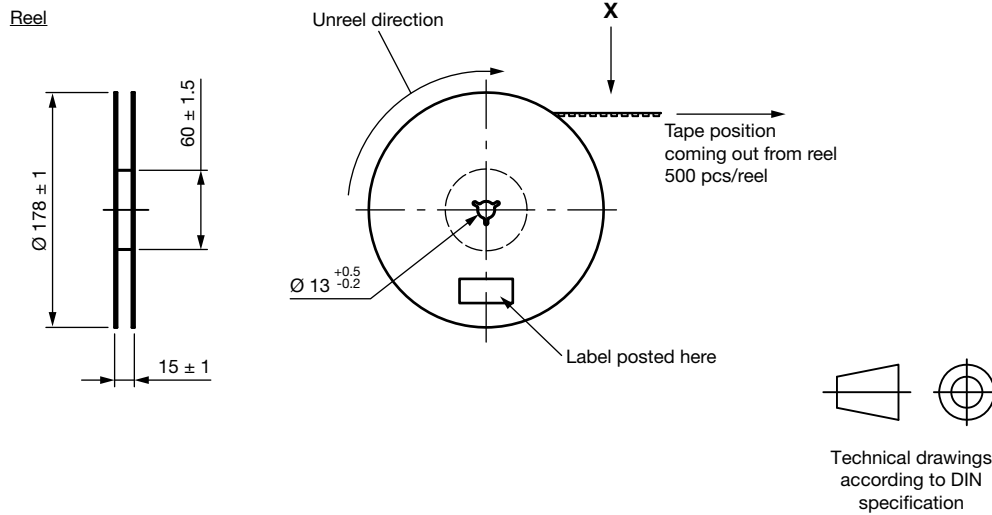

Leader and trailer tape

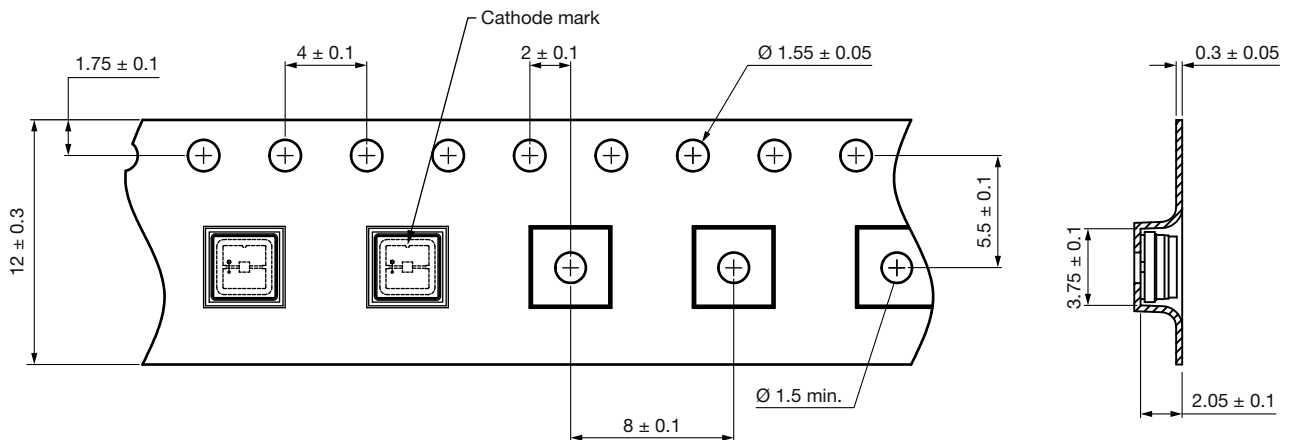
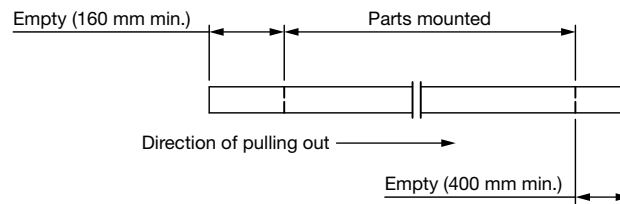

SOLDERING PROFILE

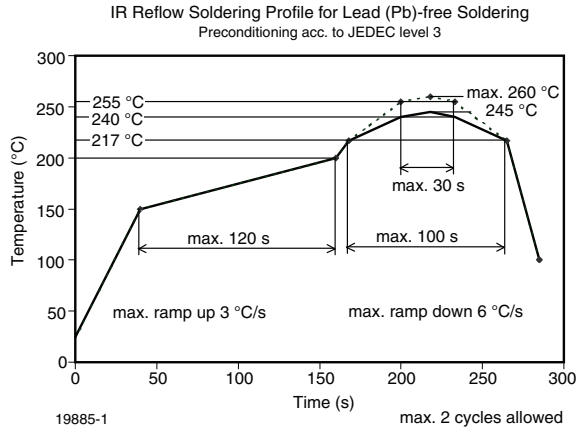
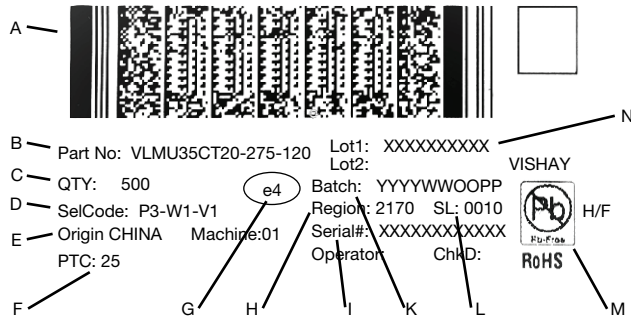

Fig. 8 - Vishay Lead (Pb)-free Reflow Soldering Profile (according to J-STD-020C)

BAR CODE PRODUCT LABEL (example only)



- A. 2D barcode
- B. Part No: Vishay part number
- C. QTY: quantity
- d. SelCode: selection bin code: $I_V - \lambda_p - V_F$
- E. Country of origin
- F. PTC: production plant code
- G. Termination finish
- H. Region code
- I. Serial#: serial number
- K. Batch number: year, week, country code, plant code
- L. SL: sales location
- M. Environmental symbols:
RoHS, lead (Pb)-free, halogen-free
- N. Lot numbers

DRY PACKING

The reel is packed in an anti-humidity bag to protect the devices from absorbing moisture during transportation and storage.

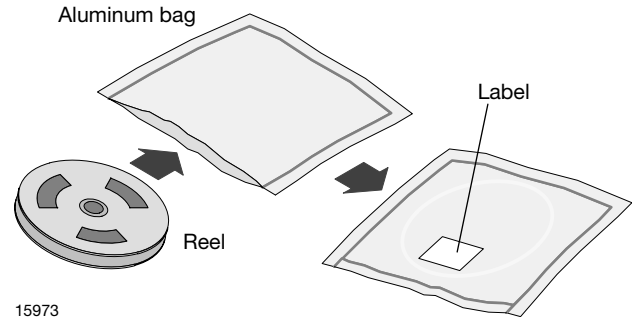

FINAL PACKING

The sealed reel is packed into a cardboard box. A secondary cardboard box is used for shipping purposes.

RECOMMENDED METHOD OF STORAGE

Dry box storage is recommended as soon as the aluminum bag has been opened to prevent moisture absorption. The following conditions should be observed, if dry boxes are not available:

- Storage temperature 10 °C to 30 °C
- Storage humidity $\leq 60\%$ RH max.

After more than 168 h under these conditions moisture content will be too high for reflow soldering.

In case of moisture absorption, the devices will recover to the former condition by drying under the following condition:
192 h at 40 °C + 5 °C / - 0 °C and < 5 % RH (dry air / nitrogen) or

24 h at 60 °C + 5 °C and < 5 % RH for all device containers or
24 h at 100 °C + 5 °C not suitable for reel or tubes.

An EIA JEDEC® standard JESD22-A112 level 3 label is included on all dry bags.

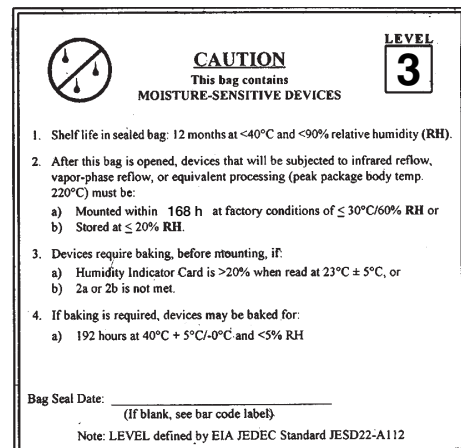

17028-2

Example of JESD22-A112 level 3 label



ESD PRECAUTION

Proper storage and handling procedures should be followed to prevent ESD damage to the devices especially when they are removed from the antistatic shielding bag. Electrostatic sensitive devices warning labels are on the packaging.

**VISHAY SEMICONDUCTORS STANDARD
BAR CODE LABELS**

The Vishay Semiconductors standard bar code labels are printed at final packing areas. The labels are on each packing unit and contain Vishay Semiconductors specific data.



Disclaimer

ALL PRODUCT, PRODUCT SPECIFICATIONS AND DATA ARE SUBJECT TO CHANGE WITHOUT NOTICE TO IMPROVE RELIABILITY, FUNCTION OR DESIGN OR OTHERWISE.

Vishay Intertechnology, Inc., its affiliates, agents, and employees, and all persons acting on its or their behalf (collectively, "Vishay"), disclaim any and all liability for any errors, inaccuracies or incompleteness contained in any datasheet or in any other disclosure relating to any product.

Vishay makes no warranty, representation or guarantee regarding the suitability of the products for any particular purpose or the continuing production of any product. To the maximum extent permitted by applicable law, Vishay disclaims (i) any and all liability arising out of the application or use of any product, (ii) any and all liability, including without limitation special, consequential or incidental damages, and (iii) any and all implied warranties, including warranties of fitness for particular purpose, non-infringement and merchantability.

Statements regarding the suitability of products for certain types of applications are based on Vishay's knowledge of typical requirements that are often placed on Vishay products in generic applications. Such statements are not binding statements about the suitability of products for a particular application. It is the customer's responsibility to validate that a particular product with the properties described in the product specification is suitable for use in a particular application. Parameters provided in datasheets and / or specifications may vary in different applications and performance may vary over time. All operating parameters, including typical parameters, must be validated for each customer application by the customer's technical experts. Product specifications do not expand or otherwise modify Vishay's terms and conditions of purchase, including but not limited to the warranty expressed therein.

Hyperlinks included in this datasheet may direct users to third-party websites. These links are provided as a convenience and for informational purposes only. Inclusion of these hyperlinks does not constitute an endorsement or an approval by Vishay of any of the products, services or opinions of the corporation, organization or individual associated with the third-party website. Vishay disclaims any and all liability and bears no responsibility for the accuracy, legality or content of the third-party website or for that of subsequent links.

Vishay products are not designed for use in life-saving or life-sustaining applications or any application in which the failure of the Vishay product could result in personal injury or death unless specifically qualified in writing by Vishay. Customers using or selling Vishay products not expressly indicated for use in such applications do so at their own risk. Please contact authorized Vishay personnel to obtain written terms and conditions regarding products designed for such applications.

No license, express or implied, by estoppel or otherwise, to any intellectual property rights is granted by this document or by any conduct of Vishay. Product names and markings noted herein may be trademarks of their respective owners.

Looking for pricing, stock, or lifecycle information?

Click below to explore more details on WIN SOURCE:

 [View VLMU35CT20-275-120 on WIN SOURCE](#)

 [Vishay Information](#)

Optimize Your Supply Chain with WIN SOURCE Solutions

-  Global Sourcing Solution
-  Obsolete Management
-  Cost Control Management
-  Shortage Management
-  Alternative Solution
-  Excess Inventory Management