



**THE DATASHEET OF
DSS1NB32A223Q91A**



EMIFIL (Three-terminal capacitor)

DSS1NB3□□□□□□□□

Reference Specification

1. Scope

This reference specification applies to DSS1NB3 series.

2. Part Numbering

(Ex.) DS S 1 N B3 2A 220 Q55 B
 ① ② ③ ④ ⑤ ⑥ ⑦ ⑧ ⑨

- ① Product ID (Disc-Type EMIFIL)
- ② Structure S : Built-in Ferrite Beads Type
- ③ Style
- ④ Features
- ⑤ Temperature Characteristics B3:±10% (-40~+85°C at 20°C)
- ⑥ Rated Voltage 2A :2A→100VDC、1H→50VDC
- ⑦ Capacitance □□□

↓
Marked three digits system.(Ex. 22pF→220、22000pF→223)

- ⑧ Lead Type
 Q55 : Bulk
 Lead Type :Straight Lead
 Lead Length(l) 25.0 mm min. ※See item 9.

- Q91□: Taping
 Lead Type :Straight Lead
 Dimension H: Q91 : 20.0±1.0 mm
 Q92 : 16.5±1.0 mm
 Q93 : 18.5±1.0 mm ※See item 9.

- ⑨ Packaging Code A : Ammo Pack / B : Bulk

3. Rating

Operating temperature : -40 to +85°C
 Storage Temperature : -40 to +85°C
 Insulation Resistance : 1000MΩ min.
 Rated Current : 6A(DC)
 Equivalent Circuit :

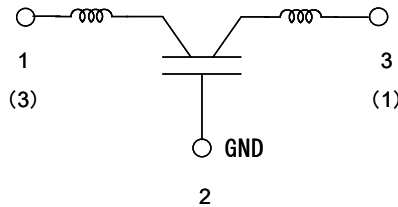

Others : See Table 1

Table 1

| Customer Part Number | Murata Part Number | Capacitance | Temperature Characteristics | Rated Voltage | Withstanding Voltage | Unit Mass (Typical value) |
|----------------------|--------------------|-------------|-----------------------------|---------------|----------------------|---------------------------|
| | DSS1NB32A220Q55B | 22 pF ± 10% | ± 10% | 100VDC | 250VDC | 0.45g |
| | DSS1NB32A220Q91A | | | | | |
| | DSS1NB32A220Q92A | | | | | |
| | DSS1NB32A220Q93A | | | | | |
| | DSS1NB32A330Q55B | 33 pF ± 10% | | | | |
| | DSS1NB32A330Q91A | | | | | |
| | DSS1NB32A330Q92A | | | | | |
| | DSS1NB32A330Q93A | | | | | |
| | DSS1NB32A470Q55B | 47 pF ± 10% | | | | |
| | DSS1NB32A470Q91A | | | | | |
| | DSS1NB32A470Q92A | | | | | |
| | DSS1NB32A470Q93A | | | | | |

Reference Only

| Customer Part Number | Murata Part Number | Capacitance | Temperature Characteristics | Rated Voltage | Withstanding Voltage | Unit Mass (Typical value) |
|----------------------|--------------------|---------------|-----------------------------|---------------|----------------------|---------------------------|
| | DSS1NB32A680Q55B | 68 pF ± 10% | ± 10% | 100VDC | 250VDC | 0.45g |
| | DSS1NB32A680Q91A | | | | | |
| | DSS1NB32A680Q92A | | | | | |
| | DSS1NB32A680Q93A | | | | | |
| | DSS1NB32A101Q55B | 100 pF ± 10% | | | | |
| | DSS1NB32A101Q91A | | | | | |
| | DSS1NB32A101Q92A | | | | | |
| | DSS1NB32A101Q93A | | | | | |
| | DSS1NB32A121Q55B | 120 pF ± 10% | | | | |
| | DSS1NB32A121Q91A | | | | | |
| | DSS1NB32A121Q92A | | | | | |
| | DSS1NB32A121Q93A | | | | | |
| | DSS1NB32A151Q55B | 150 pF ± 10% | | | | |
| | DSS1NB32A151Q91A | | | | | |
| | DSS1NB32A151Q92A | | | | | |
| | DSS1NB32A151Q93A | | | | | |
| | DSS1NB32A221Q55B | 220 pF ± 10% | | | | |
| | DSS1NB32A221Q91A | | | | | |
| | DSS1NB32A221Q92A | | | | | |
| | DSS1NB32A221Q93A | | | | | |
| | DSS1NB32A271Q55B | 270 pF ± 10% | | | | |
| | DSS1NB32A271Q91A | | | | | |
| | DSS1NB32A271Q92A | | | | | |
| | DSS1NB32A271Q93A | | | | | |
| | DSS1NB32A331Q55B | 330 pF ± 10% | | | | |
| | DSS1NB32A331Q91A | | | | | |
| | DSS1NB32A331Q92A | | | | | |
| | DSS1NB32A331Q93A | | | | | |
| | DSS1NB32A471Q55B | 470 pF ± 10% | | | | |
| | DSS1NB32A471Q91A | | | | | |
| | DSS1NB32A471Q92A | | | | | |
| | DSS1NB32A471Q93A | | | | | |
| | DSS1NB32A681Q55B | 680 pF ± 10% | | | | |
| | DSS1NB32A681Q91A | | | | | |
| | DSS1NB32A681Q92A | | | | | |
| | DSS1NB32A681Q93A | | | | | |
| | DSS1NB32A102Q55B | 1000 pF ± 10% | | | | |
| | DSS1NB32A102Q91A | | | | | |
| | DSS1NB32A102Q92A | | | | | |
| | DSS1NB32A102Q93A | | | | | |
| | DSS1NB32A152Q55B | 1500 pF ± 10% | | | | |
| | DSS1NB32A152Q91A | | | | | |
| | DSS1NB32A152Q92A | | | | | |
| | DSS1NB32A152Q93A | | | | | |
| | DSS1NB32A222Q55B | 2200 pF ± 10% | | | | |
| | DSS1NB32A222Q91A | | | | | |
| | DSS1NB32A222Q92A | | | | | |
| | DSS1NB32A222Q93A | | | | | |
| | DSS1NB32A332Q55B | 3300 pF ± 10% | | | | |
| | DSS1NB32A332Q91A | | | | | |
| | DSS1NB32A332Q92A | | | | | |
| | DSS1NB32A332Q93A | | | | | |
| | DSS1NB32A472Q55B | 4700 pF ± 10% | | | | |
| | DSS1NB32A472Q91A | | | | | |
| | DSS1NB32A472Q92A | | | | | |
| | DSS1NB32A472Q93A | | | | | |

| Customer Part Number | Murata Part Number | Capacitance | Temperature Characteristics | Rated Voltage | Withstanding Voltage | Unit Mass (Typical value) |
|----------------------|--------------------|----------------|-----------------------------|---------------|----------------------|---------------------------|
| | DSS1NB32A682Q55B | 6800 pF ± 10% | ± 10% | 100VDC | 250VDC | 0.45g |
| | DSS1NB32A682Q91A | | | | | |
| | DSS1NB32A682Q92A | | | | | |
| | DSS1NB32A682Q93A | | | | | |
| | DSS1NB32A103Q55B | 10000 pF ± 10% | | | | |
| | DSS1NB32A103Q91A | | | | | |
| | DSS1NB32A103Q92A | | | | | |
| | DSS1NB32A103Q93A | | | | | |
| | DSS1NB32A153Q55B | 15000 pF ± 10% | | | | |
| | DSS1NB32A153Q91A | | | | | |
| | DSS1NB32A153Q92A | | | | | |
| | DSS1NB32A153Q93A | | | | | |
| | DSS1NB32A223Q55B | 22000 pF ± 10% | | | | |
| | DSS1NB32A223Q91A | | | | | |
| | DSS1NB32A223Q92A | | | | | |
| | DSS1NB32A223Q93A | | | | | |
| | DSS1NB31H333Q55B | 33000 pF ± 10% | 50VDC | 125VDC | | |
| | DSS1NB31H333Q91A | | | | | |
| | DSS1NB31H333Q92A | | | | | |
| | DSS1NB31H333Q93A | | | | | |
| | DSS1NB31H473Q55B | 47000 pF ± 10% | | | | |
| | DSS1NB31H473Q91A | | | | | |
| | DSS1NB31H473Q92A | | | | | |
| | DSS1NB31H473Q93A | | | | | |
| | DSS1NB31H104Q55B | 100000pF ± 10% | | | | |
| | DSS1NB31H104Q91A | | | | | |
| | DSS1NB31H104Q92A | | | | | |
| | DSS1NB31H104Q93A | | | | | |

4. Style and Dimension

See item 9.

5. Marking

Trade Mark : Marked as 
 Capacitance : Marked three digits system. (Ex.221)
 Rated Voltage : Marked voltage value.(100V)

6. Testing Conditions

<Unless otherwise specified>

Temperature : Ordinary Temperature 15 to 35°C
 Humidity : Ordinary Humidity 25 to 85 %(RH)

<In case of doubt>

Perform a heat treatment at 150+0/-10°C for one hour and then set at room temperature for 24±2 hours.
 Temperature : 20 ± 2°C
 Humidity : 60 to 70 %(RH)
 Atmospheric Pressure : 86 to 106 kPa

7. Performance

| No. | Item | Specification | Test Method | | | | | | | | | | | | |
|-----------|-----------------------------|------------------------------------|--|---------|--|--|-----------|--------------|-------------|----------|-----------|------------|----------|-----------|----------------|
| 7.1 | Appearance and Dimensions | Meet item 9. | Visual Inspection and measured with Slide Calipers. | | | | | | | | | | | | |
| 7.2 | Marking | Marking is able to be read easily. | Visual Inspection. | | | | | | | | | | | | |
| 7.3 | Capacitance and Tolerance | Meet item 3. | <table border="1"> <thead> <tr> <th colspan="3">Table 2</th> </tr> <tr> <th>Frequency</th> <th>Test Voltage</th> <th>Capacitance</th> </tr> </thead> <tbody> <tr> <td>1±0.1MHz</td> <td>1±0.2Vrms</td> <td>22pF~150pF</td> </tr> <tr> <td>1±0.1kHz</td> <td>1±0.2Vrms</td> <td>220pF~100000pF</td> </tr> </tbody> </table> | Table 2 | | | Frequency | Test Voltage | Capacitance | 1±0.1MHz | 1±0.2Vrms | 22pF~150pF | 1±0.1kHz | 1±0.2Vrms | 220pF~100000pF |
| Table 2 | | | | | | | | | | | | | | | |
| Frequency | Test Voltage | Capacitance | | | | | | | | | | | | | |
| 1±0.1MHz | 1±0.2Vrms | 22pF~150pF | | | | | | | | | | | | | |
| 1±0.1kHz | 1±0.2Vrms | 220pF~100000pF | | | | | | | | | | | | | |
| 7.4 | Insulation Resistance(I.R.) | Meet item 3. | Test Voltage : Rated Voltage Time : 1 minute through a suitable resistor 1MΩ. | | | | | | | | | | | | |

| No. | Item | Specification | Test Method | | | | | | | | | | | | |
|----------------------|-------------------------------|--|--|-------------|--|--------------|--|-------------|---|------------|-------|------|-------|-------|-------|
| 7.5 | Withstanding Voltage | Products shall not be damaged. | Test Voltage : 2.5 times for Rated Voltage Time : 1 to 5 seconds Charge Current : 10 mA max. It shall be applied between input / output terminal and ground terminal. | | | | | | | | | | | | |
| 7.6 | Temperature Characteristics | Meet item 3. | Capacitance shall be measured at each step specified in Table 3 after reaching the thermal equilibrium. The capacitance change against the capacitance at step 3 shall be calculated. Table3 <table border="1"> <thead> <tr> <th>Step</th> <th>1</th> <th>2</th> <th>3</th> <th>4</th> <th>5</th> </tr> </thead> <tbody> <tr> <td>Temp. (°C)</td> <td>+20±2</td> <td>40±2</td> <td>+20±2</td> <td>+85±2</td> <td>+20±2</td> </tr> </tbody> </table> | Step | 1 | 2 | 3 | 4 | 5 | Temp. (°C) | +20±2 | 40±2 | +20±2 | +85±2 | +20±2 |
| Step | 1 | 2 | 3 | 4 | 5 | | | | | | | | | | |
| Temp. (°C) | +20±2 | 40±2 | +20±2 | +85±2 | +20±2 | | | | | | | | | | |
| 7.7 | Solderability | Along the circumference of terminal shall be covered with new solder at least 75%. | Flux : Ethanol solution of rosin,25(wt)% (dipped for 5 to 10 seconds) Pre-heat : 150±10°C, 60~90 s Solder : Sn-3.0Ag-0.5Cu Solder Temperature 245±5°C Immersion Time : 2 ± 0.5 seconds Immersion Depth : 2 to 2.5 mm from the bottom of the body. | | | | | | | | | | | | |
| 7.8 | Resistance to Soldering Heat① | Meet Table 4. Table 4 <table border="1"> <thead> <tr> <th>Appearance</th> <th>No damaged.</th> </tr> </thead> <tbody> <tr> <td>Capacitance Change</td> <td>within ± 30%</td> </tr> <tr> <td>Withstanding Voltage</td> <td>No damaged.</td> </tr> </tbody> </table> | Appearance | No damaged. | Capacitance Change | within ± 30% | Withstanding Voltage | No damaged. | Flux : Ethanol solution of rosin,25(wt)% (dipped for 5 to 10 seconds) Pre-heat : 150±10°C, 60~90 s Solder : Sn-3.0Ag-0.5Cu Solder Temperature : 270 ± 5 °C Immersion Time : 3± 0.5 seconds Immersion Depth : 1.6 ± 0.7 mm from the bottom of the body. Then measured after exposure in the room condition for 4 to 24hours. | | | | | | |
| Appearance | No damaged. | | | | | | | | | | | | | | |
| Capacitance Change | within ± 30% | | | | | | | | | | | | | | |
| Withstanding Voltage | No damaged. | | | | | | | | | | | | | | |
| | Resistance to Soldering Heat② | | Soldering iron output: 30W Tip temperature : 370±10°C Soldering time : 5s(+0/-1s) | | | | | | | | | | | | |
| 7.9 | Humidity | Meet Table 5. Table 5 <table border="1"> <thead> <tr> <th>Appearance</th> <th>No damaged.</th> </tr> </thead> <tbody> <tr> <td>Capacitance Change</td> <td>within ± 30%</td> </tr> </tbody> </table> | Appearance | No damaged. | Capacitance Change | within ± 30% | Temperature : 60°C Humidity : 90 to 95 %(RH) Time : 500 hours(+24-0 hours) Then measured after exposure in the room condition for 4 to 24hours. | | | | | | | | |
| Appearance | No damaged. | | | | | | | | | | | | | | |
| Capacitance Change | within ± 30% | | | | | | | | | | | | | | |
| 7.10 | Humidity Life | <table border="1"> <thead> <tr> <th>Inslation Resistance</th> <th>10MΩ min.</th> </tr> </thead> <tbody> </tbody> </table> | Inslation Resistance | 10MΩ min. | Temperature : 40 ± 2°C Humidity : 90 to 95 %(RH) Time : 500 hours(+24-0 hours) Applying Voltage : 1H/ Rated Voltage 50VDC 2A/ Rated Voltage 100VDC Then measured after exposure in the room condition for 4 to 24hours. | | | | | | | | | | |
| Inslation Resistance | 10MΩ min. | | | | | | | | | | | | | | |
| 7.11 | Heat Life | | Temperature : 85 ± 3°C Applying Voltage : 1H/ Rated Voltage 50VDC 2A/ Rated Voltage 100VDC Time : 500 hours(+24-0 hours) Then measured after exposure in the room condition for 4 to 24hours. | | | | | | | | | | | | |

9.2 Taping(Straight Lead Type) : Q9□A

(All symbols in the illustrations below are described in Table 6)

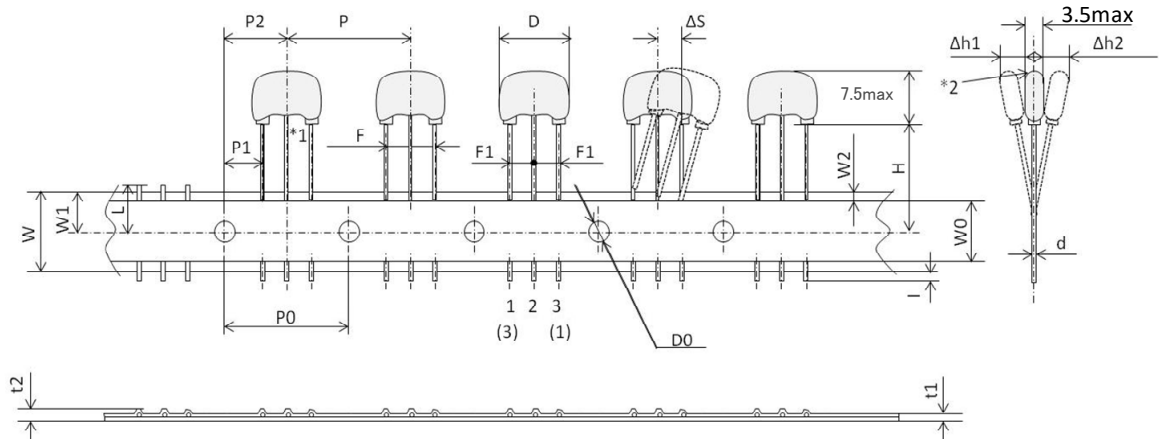

- *1. Bottom of dielectric may be exposed.
- *2. There should not be the exposure of the ferrite bead if a hole is on the top of ferrite bead.

Table 6

| Code | Description | Dimensions | Remark |
|------|--|---------------|---|
| P | Pitch of Component | 12.7 | Product Inclination ΔS Determines Crossing |
| P0 | Pitch of Sprocket Hole | 12.7±0.2 | |
| P1 | Length from Hole Center to Lead | 3.85±0.7 | |
| P2 | Length from Hole Center to Component Center | 6.35±1.3 | |
| D | Width of Body | 8.5 max. | |
| ΔS | Deviation along tape, Left or Right | 0±1.0 | |
| W | Carrier Tape Width | 18.0±0.5 | |
| W1 | Position of Sprocket Hole | 9.0 +0,-0.5 | Tape Widthwise Shift |
| l | Protrusion Length | +0.5 ~ -1.0 | |
| D0 | Diameter of Sprocket Hole | φ 4.0±0.1 | |
| d | Lead Diameter | φ 0.6 | |
| t1 | Total Tape Thickness | 0.7±0.2 | Includes Thickness of Bonding Tape |
| t2 | Total Thickness, Tape and Lead Wire | 1.5 max. | |
| Δh1 | Deviation across Tape, front | 1.0 max. | |
| Δh2 | Deviation across Tape, rear | 1.0 max. | |
| L | Portion to Cut in Case of Defect | 11.0 +0,-1.0 | |
| W0 | Hold Down Tape Width | 12.0±0.5 | |
| W2 | Hold Down Tape Position | 1.5±1.5 | |
| H | Lead length between sprocket hole and forming position | Q91 | 20.0±1.0 |
| | | Q92 | 16.5±1.0 |
| | | Q93 | 18.5±1.0 |
| F | Lead Spacing | 5.0 +0.8,-0.2 | |
| F1 | | 2.5 +0.4,-0.2 | |

(in mm)

10. Taping

- (1) A maximum of 0.3% of the components quantity per Ammo pack may be missing without consecutive missing components.
- (2) The adhesive power of the tape shall have over 2.94N at the following condition.

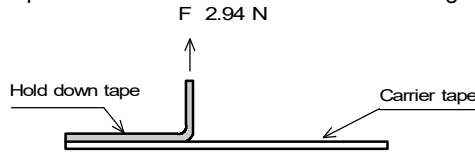

(3) Splicing method of tape

1. Carrier tape

Carrier tape shall be spliced by cellophane tape.
Overall thickness shall be less than 1.05 mm.

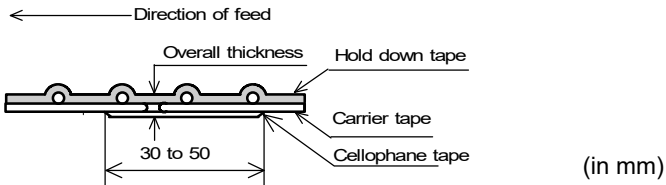

2. Hold down tape

Hold down tape shall be spliced with overlapping.
Overall thickness shall be less than 1.05 mm.

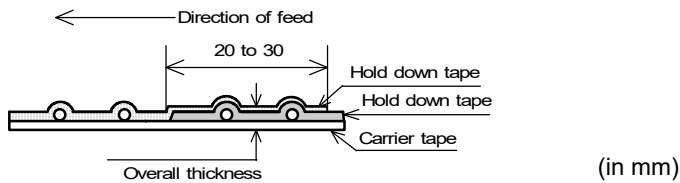

3. Both carrier tape and hold down tape

Both tapes shall be cut zigzag and spliced with splicing tape.

11. Packing

11.1 Packing quantity

The standard packing quantity is as follows.

(The packing quantity may be changed due to a fraction of order.)

Minimum Packing Form and Quantity

| Terminal Configuration | A Unit Quantity | Packing Form | * Standard Quantity in a container (corrugated cardboard box) |
|------------------------|-----------------|------------------|---|
| Bulk | 250 pcs. | In a plastic bag | 5000pcs. |
| Taping | 1500 pcs. | In an Ammo pack | 7500pcs. |

* A quantity in a container is depending on a quantity of an order.

11.2 Packing Form

(1) Bulk

<A plastic bag pack>

1. Products are packed into a plastic bag.

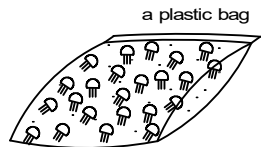

2. The plastic bags are put into a container (corrugated cardboard box) depending on a quantity of an order.

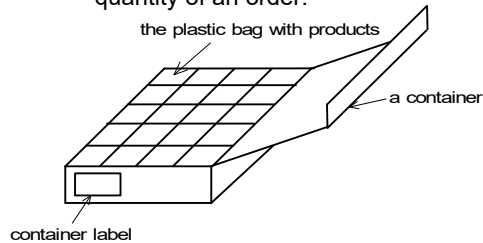

(2) Taping

<An ammo pack>

1. Folding the tape per 25 pitches, products are packed into an ammo package so that each product of each layer wound zigzag is put on top of one another. [Fig 1]
2. The dimensions of the ammo package are indicated in [Fig 2].
3. The ammo packages are put into a container (corrugated cardboard box) depending on a quantity of an order.
4. Not less than 3 consecutive of component shall be missing on both edge of tape.

[Fig 1] zig zag

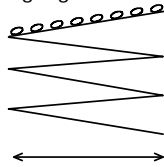

The unloading direction : Right

The hold down tape : Upper

The product body : Left along the unloading direction

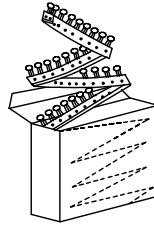

[Fig 2]

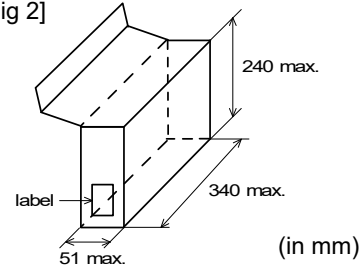

(in mm)

12. Marking on package**12.1 Unit Package**

Bulk : Marked on a plastic bag.

Taping : Marked on a label stuck on an ammo package.

Marking on a unit package consists of :

Customer part number, MURATA part number, Inspection number(*1), RoHS marking (*2), Quantity, etc

*1) « Expression of Inspection No. »

| | | |
|-----|------|-----|
| □□ | OOOO | XXX |
| (1) | (2) | (3) |

(1) Factory Code

(2) Date

First digit : Year / Last digit of year

Second digit : Month / Jan. to Sep. → 1 to 9, Oct. to Dec. → O,N,D

Third, Fourth digit : Day

(3) Serial No.

*2) « Expression of RoHS marking »

| |
|--------------|
| ROHS - Y (Δ) |
| (1) (2) |

(1) RoHS regulation conformity parts.

(2) MURATA classification number

12.2 Container

Marking on the label stuck on a container consists of :

Customer name Purchasing Order Number, Customer Part Number, MURATA part number,

RoHS marking (*2), Quantity, etc

13. ⚠ Caution**13.1 Mounting holes**

Mounting holes should be designed as specified in this specifications.

Or different design from this specifications may cause cracks in ceramics which may lead to smoking / firing.

13.2 Caution for the product angle adjust work

Take care not to apply any mechanical stress to product body at the lead terminal bending process for product angle adjustment after insertion.

13.3 Limitation of Applications

Please contact us before using our products for the applications listed below which require especially high reliability for the prevention of defects which might directly cause damage to the third party's life, body or property.

- | | |
|--|--|
| (1) Aircraft equipment | (7) Traffic signal equipment |
| (2) Aerospace equipment | (7) Disaster prevention / crime prevention equipment |
| (3) Undersea equipment | (9) Data-processing equipment |
| (4) Power plant control equipment | (10) Applications of similar complexity and /or reliability requirements |
| (5) Medical equipment | to the applications listed in the above |
| (6) Transportation equipment (vehicles, trains, ships, etc.) | |

14. Notice**14.1 Soldering**

- (1) Use rosin-based flux. Do not use strong acidic flux with halide content exceeding 0.2(wt)% (chlorine conversion value).
Use Sn-3.0Ag-0.5Cu solder

- (2) Standard flow soldering profile.

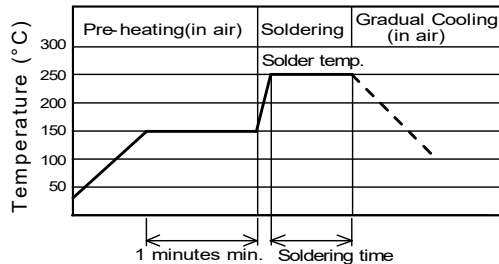

| Solder temperature | Soldering time |
|--------------------|----------------|
| 250~260 °C | 4~6s |

- (3) Resistance to soldering iron goes in the following condition that tip temperature is 350 °C max. And soldering time is 5 s max.
(4) Products and the leads should not be subjected to any mechanical stress during soldering process. (and also while subjected to the equivalent high temperature.)

14.2 Cleaning

Products shall be cleaned on following conditions.

- (1) Cleaning Temperature: 60°C max. (40°C max. for Isopropyl alcohol).
(2) Ultrasonic cleaning shall comply with the following conditions, avoiding the resonance phenomenon at the mounted products and P.C.B.
Power : 20W / l max.
Frequency : 28kHz ~ 40kHz
Time : 5 minutes max.
(3) Cleaning agent
1. alcohol cleaning agents.
• Isopropyl alcohol (IPA)
2. Aqueous cleaning agent
• Pine Alpha ST-100S
(4) Ensure that residual flux and residual cleaning agent is completely removed.
Products should be thoroughly dried after aqueous agent has been removed with de-ionized water.
(5) For other cleaning methods, please contact Murata engineering.

14.3 Operating Environment

- (1) Do not use products in corrosive gases such as chlorine gas, acid or sulfide gas.
(2) Do not use products in the environment where water, oil or organic solvents may adhere to products.
(3) Do not adhere any resin to products, coat nor mold products with any resin (including adhesive) to prevent mechanical and chemical stress on products.

14.4 Storage and handling requirements.

- (1) Storage period
Use the products within 12 months after delivered.
Solderability should be checked if this period is exceeded.
(2) Storage environment condition
To prevent products quality deterioration, stored conditions should be controlled as follows ;
1. Temperature : -10 to 40 degrees centigrade
2. Humidity : 15 to 85% relative humidity
3. Products should be stored without sudden changes in temperature and humidity.
Don't keep products in corrosive gases such as sulfur, chlorine gas or acid,
or it may cause oxidization of lead terminals resulting in poor solderability.
4. Products should be stored on the palette for the prevention of the influence from humidity, dust and so on.
5. Products should be stored in the warehouse without heat shock, vibration, direct sunlight and so on.
(3) Handling Conditions
Care should be taken when transporting or handling product to avoid excessive vibration or mechanical shock.

15.  Note

- (1) Please make sure that your product has been evaluated in view of your specifications with our product being mounted to your product.
(2) You are requested not to use our product deviating from the reference specifications.
(3) The contents of this reference specification are subject to change without advance notice. Please approve our product specifications or transact the approval sheet for product specifications before ordering.

Looking for pricing, stock, or lifecycle information?

Click below to explore more details on WIN SOURCE:

- [View DSS1NB32A223Q91A on WIN SOURCE](#)
- [Murata Electronics North America Information](#)

Optimize Your Supply Chain with WIN SOURCE Solutions

- ✓ Global Sourcing Solution
- ✓ Obsolete Management
- ✓ Cost Control Management
- ✓ Shortage Management
- ✓ Alternative Solution
- ✓ Excess Inventory Management