



**THE DATASHEET OF
TL2243**





SERIES TL 2243 SWITCHES

TACT SWITCHES - Dual

TACT SWITCHES

NAVIGATION SWITCHES

PUSHBUTTON SWITCHES

TOGGLE SWITCHES

ROCKER SWITCHES

SLIDE SWITCHES

SNAP-ACTION SWITCHES

DIP SWITCHES

KEYLOCK SWITCHES

ROTARY SWITCHES

DETECTOR SWITCHES

CAP OPTIONS



SPECIFICATIONS

Contact Rating:	50mA @ 12 VDC
Life Expectancy:	30,000 cycles
Contact Resistance:	100mΩ max.
Insulation Resistance:	100MΩ min. @ 100VDC
Dielectric Strength:	250VAC
Actuation Force:	180 ±50 gf
Operating Temperature:	-20°C to 70°C
Travel:	0.25 +0.2mm / -0.1mm

FEATURES & BENEFITS

- ▶ Low profile
- ▶ Tactile feel
- ▶ Saves space on the PC Board

APPLICATIONS/MARKETS

- ▶ Telecommunications
- ▶ Consumer Electronics
- ▶ Audio/visual
- ▶ Medical
- ▶ Testing/instrumentation
- ▶ Computer/servers/peripherals



HOW TO ORDER

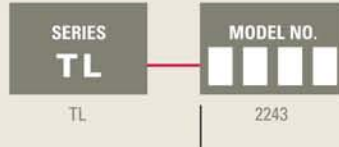

▶ ▶ ▶ Example Ordering Number
TL-2243

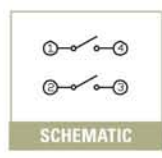
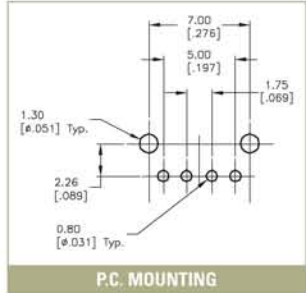
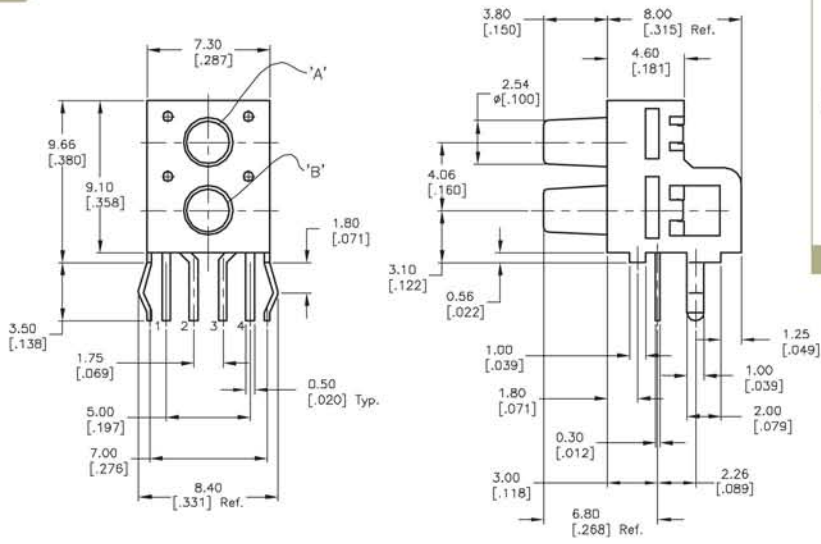

Specifications subject to change without notice.

TL 2243









Looking for pricing, stock, or lifecycle information?

Click below to explore more details on WIN SOURCE:

-  [View TL2243 on WIN SOURCE](#)
-  [E-Switch Information](#)

Optimize Your Supply Chain with WIN SOURCE Solutions

-  Global Sourcing Solution
-  Obsolete Management
-  Cost Control Management
-  Shortage Management
-  Alternative Solution
-  Excess Inventory Management