



**THE DATASHEET OF
PTS645VL83-2 LFS**



PTS645 Series 6 mm Tact Switches



Features/Benefits

- Compact size 6 x 6 mm
- Variety of actuator lengths
- Choice of actuation force
- RoHS compliant and compatible

Typical Applications

- Consumer products
- Instrumentation
- Computer products
- Industrial

Specification

FUNCTION: Momentary action
CONTACT ARRANGEMENT: SPST, N.O.
TERMINALS: PC pins

Mechanical

LIFE EXPECTANCY: 100,000 operations.

Electrical

CONTACT RATING: 50 mA @ 12 V DC.
DIELECTRIC STRENGTH: 250 V AC min.
CONTACT RESISTANCE: 100 mΩ max. initial.
INSULATION RESISTANCE: 10¹¹ Ω min.

Environmental

OPERATING TEMPERATURE: -40°C to 85°C
STORAGE TEMPERATURE: -40°C to 85°C

Process

SOLDERING: Preheating to 100°C for 45 sec. max. Keep flux flush with top surface of PCB; do not apply to component side of PCB and area where terminals are located. Soldering to 255°C for 5 sec. max. Clean by brushing on solder surface. Do not clean switch with solvents.

Packaging

Bulk packaging

Tape & reel for the SMT type:

Reels of 1,000 pieces for 4.3 and 5.0 mm height
Reels of 700 pieces for 7.0 mm height
Reels of 700 pieces for 7.3 mm height
Reels of 500 pieces for 9.5 mm height
Reels of 400 pieces for 13.0 mm height

NOTE:

- Specifications listed above are for switches with standard options. For information on specific and custom switches, consult Customer Service Center.
- The PTS series is not certified for using in Automotive application and no PPAP. However, in the case of some automotive accessories and specific applications for 2 and 3 wheeled vehicles the PTS is widely used and very suitable. Please contact your local C&K representative to discuss your application and the best switch solution.

How To Order

Our easy build-a-switch concept allows you to mix and match options to create the switch you need. To order, select desired option from each category and place it in the appropriate box.

P	T	S	6	4	5														L	F	S
																		<p>Termination</p> <p>S Straight T Straight with ESD pin V Vertical THT</p> <p>Actuator Shape</p> <p>NONE Round actuator, All versions J Square actuator, 2.4 mm side (available for Straight 7.3 mm and Vertical 6.15 mm)</p> <p>Actuation Force</p> <p>N 100 gf L 130 gf M 160 gf H 200 gf K 260 gf P 320 gf</p>	<p>Insertion Type</p> <p>2 Thru hole SMTR92* Surface mount G-type, tape & reel JSMTR92* Surface mount J-type, tape & reel</p> <p>Switch height from PCB for S and T only (H dimension see actuator height drawings)</p> <p>43 4.3 (.169), thru-hole and SMT 50 5.0 (.197), thru-hole and SMT 70 7.0 (.275), thru-hole and SMT 73 7.3 (.287), thru-hole and SMT, square actuator 2.4 mm side only 95 9.5 (.374), thru-hole and SMT 13 13.0 (.512) SMT only 11 11.0 (.433) SMT only</p> <p>Switch length from front leads for V only (H dimension see actuator height drawings)</p> <p>31 3.15 (.124), vertical 39 3.85 (.151), vertical 58 5.85 (.230), vertical 61 6.15 (.242), vertical, square actuator 2.4 mm side only 83 8.35 (.329), vertical</p>	<p>RoHS compliant and compatible. Silver plated.</p>	

*Only the straight type termination without ESD pin is available in SMT type
* Long life version has to be created case by case as special part number



TERMINATION

S STRAIGHT

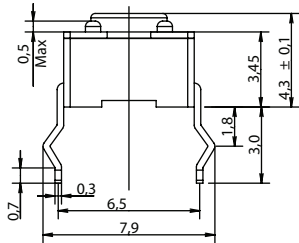

SCHEMATIC

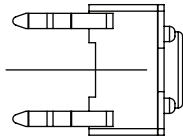
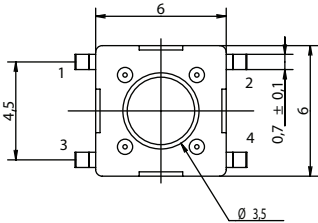
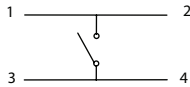

PCB LAYOUT

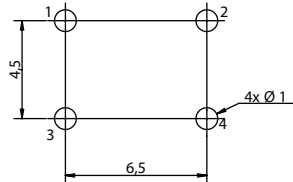

T STRAIGHT WITH ESD PIN

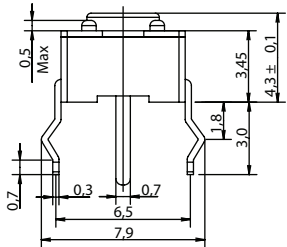

SCHEMATIC

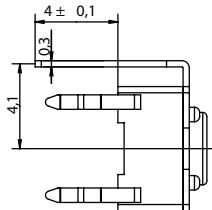
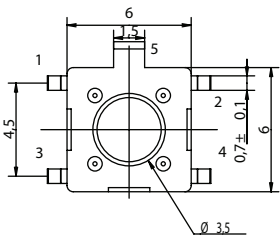
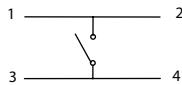

PCB LAYOUT

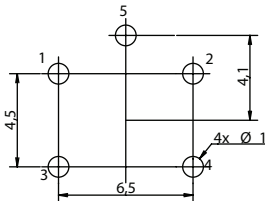

V VERTICAL THT

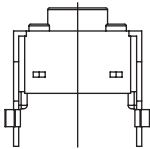

SCHEMATIC

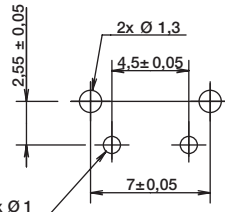
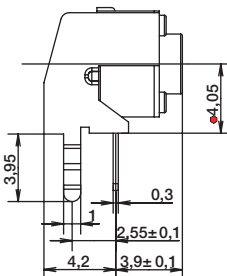
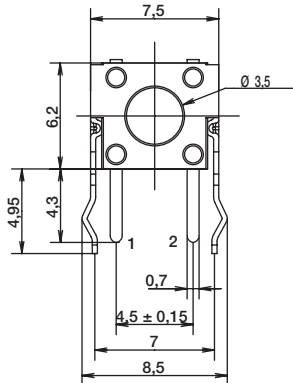
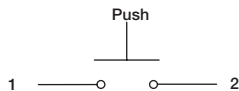

PCB LAYOUT



Dimensions are shown: mm
Specifications and dimensions subject to change



PTS645 Series 6 mm Tact Switches

TERMINATION

SMT G Type

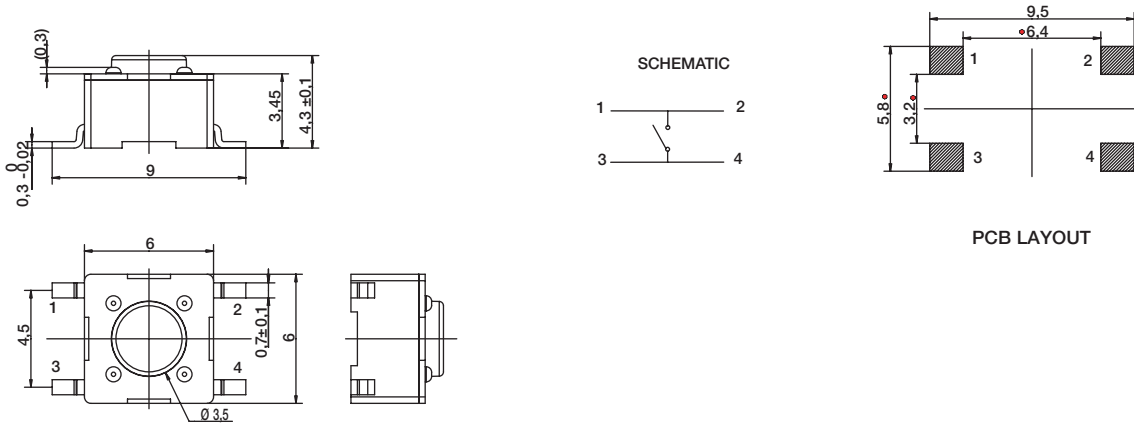

SMT J Type

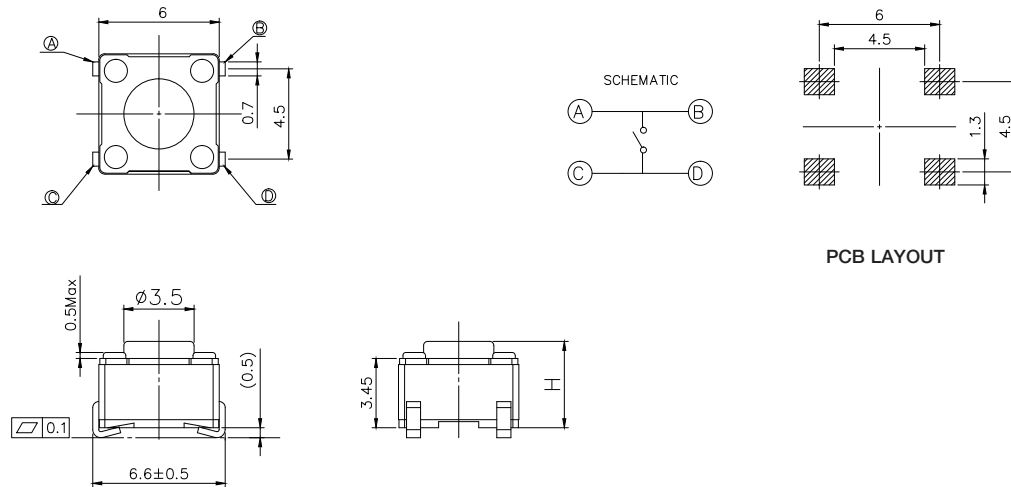

ACTUATOR SHAPE

J SQUARE ACTUATOR

VERTICAL THT - FOR 6.15MM LENGTH ONLY

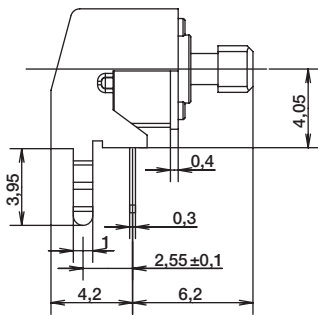
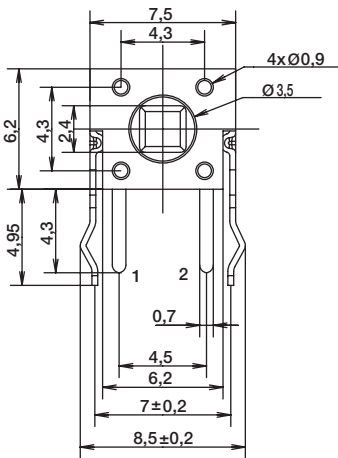
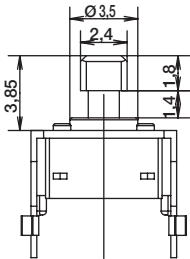

SCHEMATIC

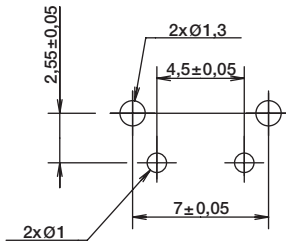
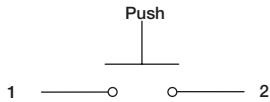

RECOMMENDED PCB LAYOUT

STRAIGHT THT - FOR 7.3MM HEIGHT ONLY

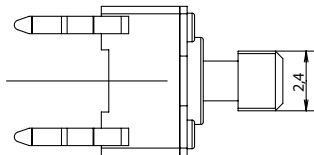
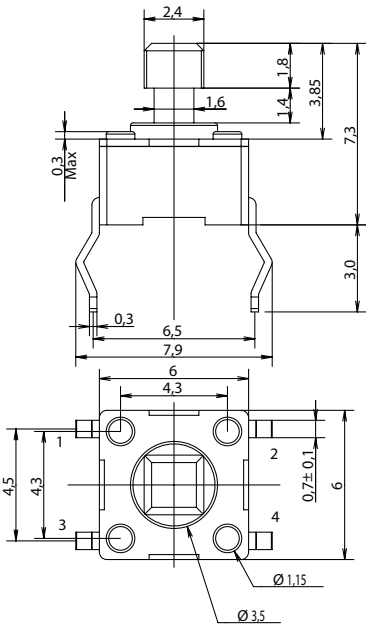

SCHEMATIC

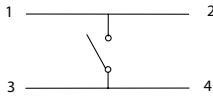

RECOMMENDED PCB LAYOUT

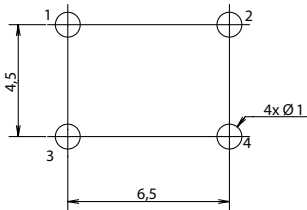

First Angle
Projection



PTS645 Series 6 mm Tact Switches

ACTUATOR SHAPE

STRAIGHT SMT G TYPE - FOR 7.3MM HEIGHT ONLY

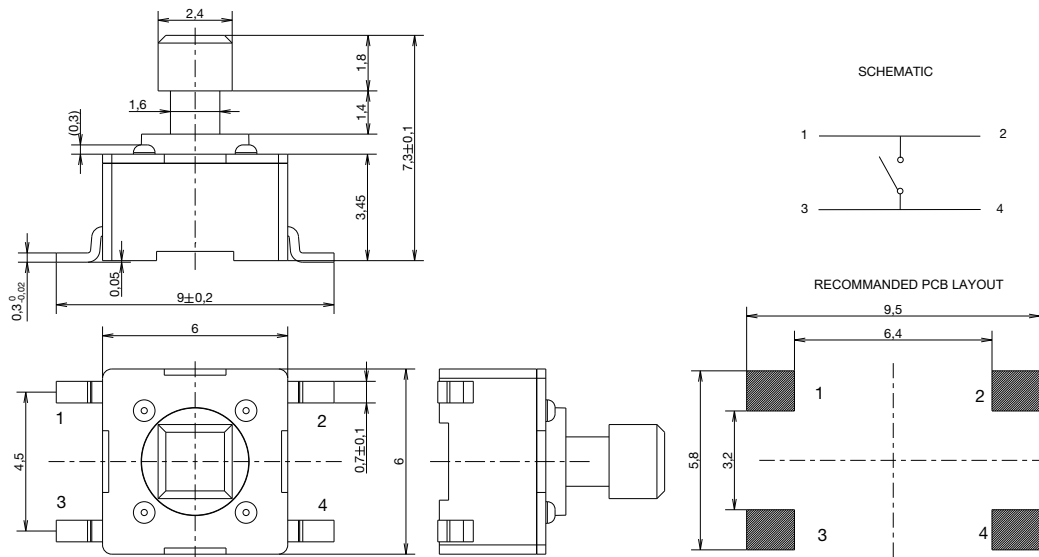

STRAIGHT SMT J TYPE - FOR 7.3MM HEIGHT ONLY

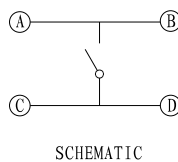
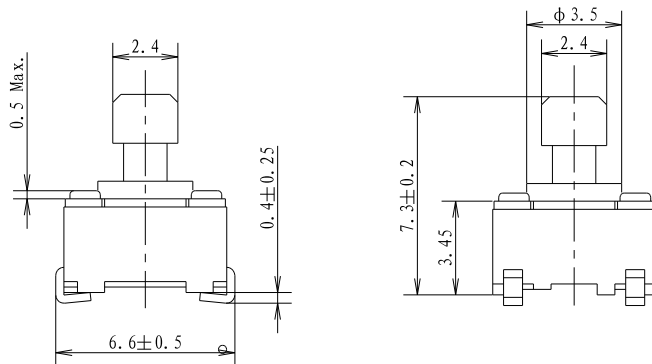
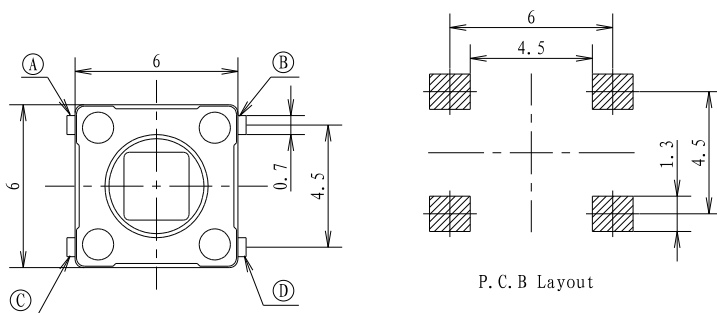

Dimensions are shown: mm
Specifications and dimensions subject to change

PTS645 Series 6 mm Tact Switches

ACTUATOR SHAPE

STRAIGHT SMT - FOR 7.3MM HEIGHT ONLY

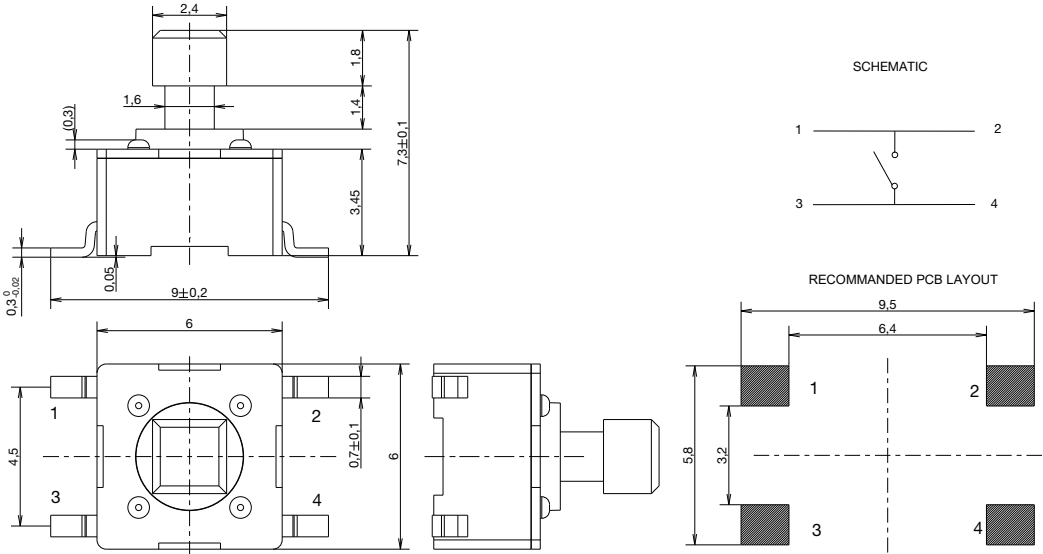

Tactile Switches

B



14 Nov 22



Dimensions are shown: mm
Specifications and dimensions subject to change

PTS645 Series 6 mm Tact Switches

ACTUATION FORCE

OPTION CODE	FORCE
L	130 grams Black
M	160 grams Blue
H	200 grams Gray
K	260 grams Red

ACTUATOR HEIGHT

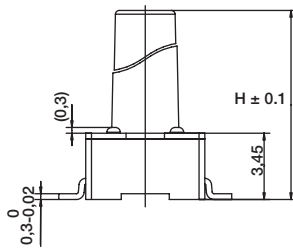

Switch height from PCB for S and T only

OPTION CODE	DIMENSION H	TERMINATION	SCHEMATIC	
			Without EMC pin	With EMC pin
43	4,3 (.169)	Thru-hole and SMT		
50	5,0 (.197)	Thru-hole and SMT		
70	7,0 (.275)	Thru-hole and SMT		
95	9,5 (.374)	Thru-hole and SMT		
13	13,0 (.512)	SMT		

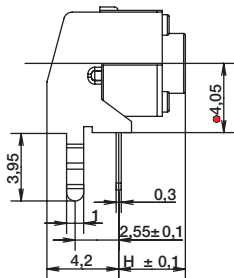

Switch length from front leads for V only

OPTION CODE	DIMENSION H	TERMINATION	SCHEMATIC	
			Without EMC pin	With EMC pin
31	3,15 (.124)	Vertical		
39	3,85 (.151)	Vertical		
58	5,85 (.230)	Vertical		
83	8,35 (.329)	Vertical		

TAPE & REEL FOR SMT G TYPE VERSIONS

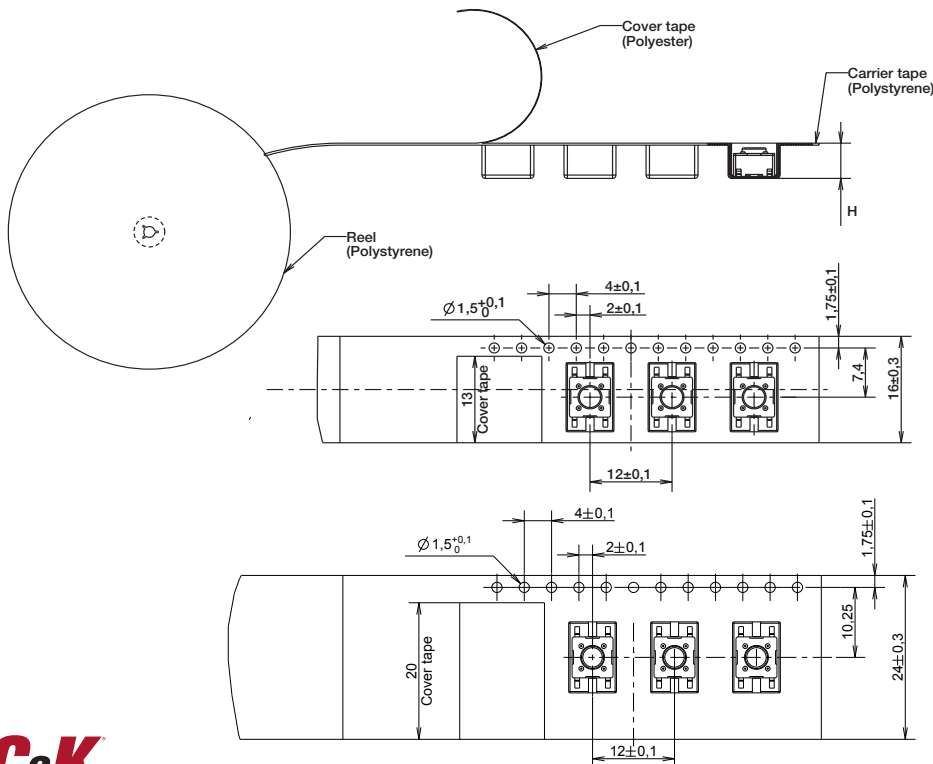

OPTION CODE	WIDTH TAPE	POCKET HEIGHT
43	16 ± 0.3	5.3
50	16 ± 0.3	5.3
70	16 ± 0.3	7.3
73	16 ± 0.3	7.6
95	24 ± 0.3	10.3
13	24 ± 0.3	13.3



Dimensions are shown: mm
Specifications and dimensions subject to change

PTS645 Series 6 mm Tact Switches

TAPE & REEL FOR SMT J TYPE VERSIONS

Tactile Switches B

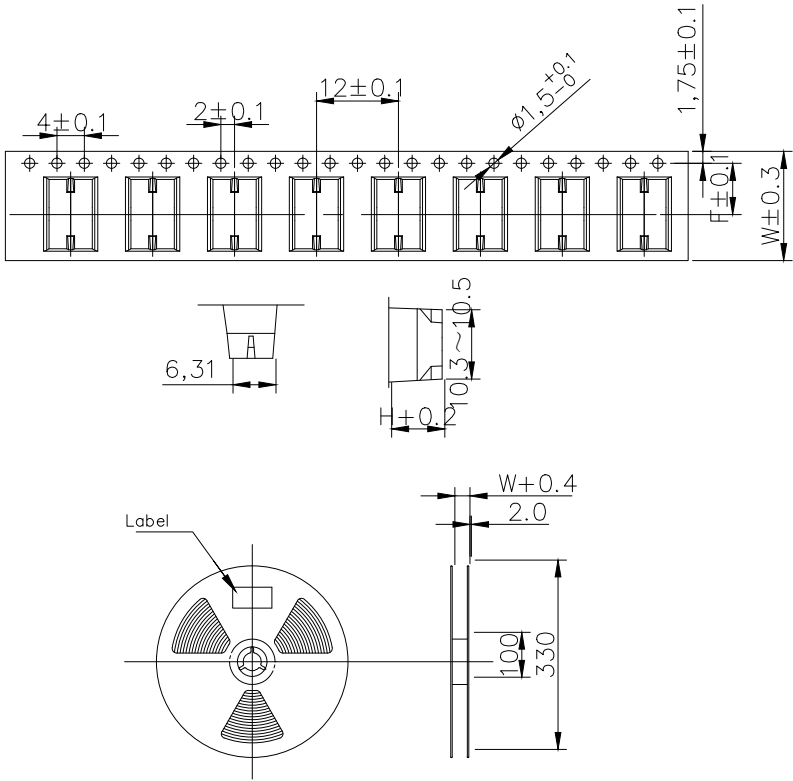

Tape specifications

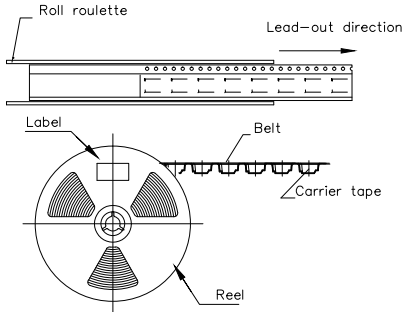

Product height (h)mm	Carrier tape width (W)mm	Center distance of carrier tape (F)mm	pcs/reel
4.3	16	7.5	1000
5.0	16	7.5	1000
7.0	16	7.5	700
7.3	16	7.5	700
9.5	24	11.5	500
11	24	11.5	500
13	24	11.5	500

Note: The disc rotates counterclockwise. According to the packing shown in the figure, the braid must not be twisted to prevent product deformation;





Looking for pricing, stock, or lifecycle information?

Click below to explore more details on WIN SOURCE:

-  [View PTS645VL83-2 LFS](#) on WIN SOURCE
-  [C&K Components](#) Information

Optimize Your Supply Chain with WIN SOURCE Solutions

-  Global Sourcing Solution
-  Obsolete Management
-  Cost Control Management
-  Shortage Management
-  Alternative Solution
-  Excess Inventory Management