



# THE DATASHEET OF ESP32-WROOM-32-N8



# ESP32 Series

## Datasheet

2.4 GHz Wi-Fi + Bluetooth® + Bluetooth LE SoC

### Including:

ESP32-D0WD-V3

ESP32-D0WDR2-V3

ESP32-U4WDH

ESP32-S0WD – [Not Recommended for New Designs \(NRND\)](#)

ESP32-D0WD – [Not Recommended for New Designs \(NRND\)](#)

ESP32-D0WDQ6 – [Not Recommended for New Designs \(NRND\)](#)

ESP32-D0WDQ6-V3 – [Not Recommended for New Designs \(NRND\)](#)



Version 4.5  
Espressif Systems  
Copyright © 2024

# Product Overview

ESP32 is a single 2.4 GHz Wi-Fi-and-Bluetooth combo chip designed with the TSMC low-power 40 nm technology. It is designed to achieve the best power and RF performance, showing robustness, versatility and reliability in a wide variety of applications and power scenarios.

The ESP32 series of chips includes ESP32-D0WD-V3, ESP32-D0WDR2-V3, ESP32-U4WDH, ESP32-S0WD ([NRND](#)), ESP32-D0WDQ6-V3 ([NRND](#)), ESP32-D0WD ([NRND](#)), and ESP32-D0WDQ6 ([NRND](#)), among which,

- ESP32-S0WD ([NRND](#)), ESP32-D0WD ([NRND](#)), and ESP32-D0WDQ6 ([NRND](#)) are based on chip revision v1 or chip revision v1.1.
- ESP32-D0WD-V3, ESP32-D0WDR2-V3, ESP32-U4WDH, and ESP32-D0WDQ6-V3 ([NRND](#)) are based on chip revision v3.0 or chip revision v3.1.

For details on part numbers and ordering information, please refer to Section 1 [ESP32 Series Comparison](#). For details on chip revisions, please refer to [ESP32 Chip Revision v3.0 User Guide](#) and [ESP32 Series SoC Errata](#).

The functional block diagram of the SoC is shown below.

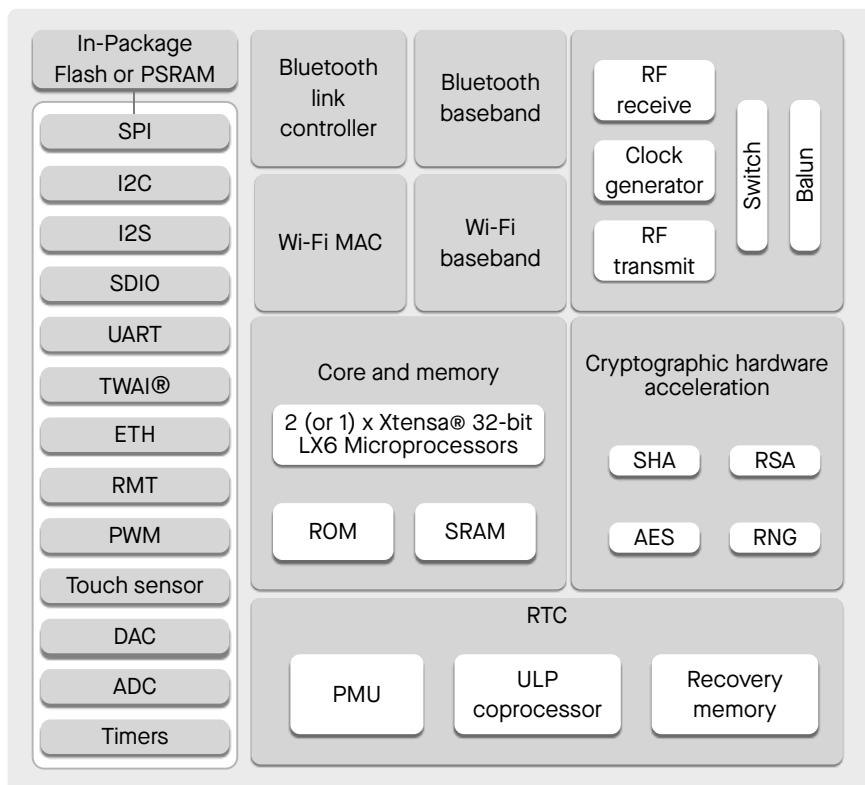

ESP32 Functional Block Diagram

# Features

## Wi-Fi

- 802.11b/g/n
- 802.11n (2.4 GHz), up to 150 Mbps
- WMM
- TX/RX A-MPDU, RX A-MSDU
- Immediate Block ACK
- Defragmentation
- Automatic Beacon monitoring (hardware TSF)
- Four virtual Wi-Fi interfaces
- Simultaneous support for Infrastructure Station, SoftAP, and Promiscuous modes  
Note that when ESP32 is in Station mode, performing a scan, the SoftAP channel will be changed.
- Antenna diversity

## Bluetooth®

- Compliant with Bluetooth v4.2 BR/EDR and Bluetooth LE specifications
- Class-1, class-2 and class-3 transmitter without external power amplifier
- Enhanced Power Control
- +9 dBm transmitting power
- NZIF receiver with -94 dBm Bluetooth LE sensitivity
- Adaptive Frequency Hopping (AFH)
- Standard HCI based on SDIO/SPI/UART
- High-speed UART HCI, up to 4 Mbps
- Bluetooth 4.2 BR/EDR and Bluetooth LE dual mode controller
- Synchronous Connection-Oriented/Extended (SCO/eSCO)
- CVSD and SBC for audio codec
- Bluetooth Piconet and Scatternet
- Multi-connections in Classic Bluetooth and Bluetooth LE
- Simultaneous advertising and scanning

## CPU and Memory

- Xtensa® single-/dual-core 32-bit LX6 microprocessor(s)
- CoreMark® score:
  - 1 core at 240 MHz: 504.85 CoreMark; 2.10 CoreMark/MHz

- 2 cores at 240 MHz: 994.26 CoreMark; 4.14 CoreMark/MHz
- 448 KB ROM
- 520 KB SRAM
- 16 KB SRAM in RTC
- QSPI supports multiple flash/SRAM chips

### Clocks and Timers

- Internal 8 MHz oscillator with calibration
- Internal RC oscillator with calibration
- External 2 MHz ~ 60 MHz crystal oscillator (40 MHz only for Wi-Fi/Bluetooth functionality)
- External 32 kHz crystal oscillator for RTC with calibration
- Two timer groups, including 2 × 64-bit timers and 1 × main watchdog in each group
- One RTC timer
- RTC watchdog

### Advanced Peripheral Interfaces

- 34 programmable GPIOs
  - Five strapping GPIOs
  - Six input-only GPIOs
  - Six GPIOs needed for in-package flash/PSRAM (ESP32-D0WDR2-V3, ESP32-U4WDH)
- 12-bit SAR ADC up to 18 channels
- Two 8-bit DAC
- 10 touch sensors
- Four SPI interfaces
- Two I2S interfaces
- Two I2C interfaces
- Three UART interfaces
- One host (SD/eMMC/SDIO)
- One slave (SDIO/SPI)
- Ethernet MAC interface with dedicated DMA and IEEE 1588 support
- TWA1<sup>®</sup>, compatible with ISO 11898-1 (CAN Specification 2.0)
- RMT (TX/RX)
- Motor PWM
- LED PWM up to 16 channels

## Power Management

- Fine-resolution power control through a selection of clock frequency, duty cycle, Wi-Fi operating modes, and individual power control of internal components
- Five power modes designed for typical scenarios: Active, Modem-sleep, Light-sleep, Deep-sleep, Hibernation
- Power consumption in Deep-sleep mode is 10  $\mu\text{A}$
- Ultra-Low-Power (ULP) coprocessors
- RTC memory remains powered on in Deep-sleep mode

## Security

- Secure boot
- Flash encryption
- 1024-bit OTP, up to 768-bit for customers
- Cryptographic hardware acceleration:
  - AES
  - Hash (SHA-2)
  - RSA
  - ECC
  - Random Number Generator (RNG)

## Applications

With low power consumption, ESP32 is an ideal choice for IoT devices in the following areas:

- Smart Home
- Industrial Automation
- Health Care
- Consumer Electronics
- Smart Agriculture
- POS machines
- Service robot
- Audio Devices
- Generic Low-power IoT Sensor Hubs
- Generic Low-power IoT Data Loggers
- Cameras for Video Streaming
- Speech Recognition
- Image Recognition
- SDIO Wi-Fi + Bluetooth Networking Card
- Touch and Proximity Sensing

**Note:**

Check the link or the QR code to make sure that you use the latest version of this document:  
[https://www.espressif.com/documentation/esp32\\_datasheet\\_en.pdf](https://www.espressif.com/documentation/esp32_datasheet_en.pdf)

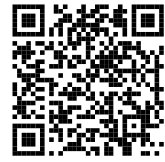

## Contents

<b>Product Overview</b>	2
Features	3
Applications	5
<b>1 ESP32 Series Comparison</b>	11
1.1 Nomenclature	11
1.2 Comparison	11
<b>2 Pins</b>	12
2.1 Pin Layout	12
2.2 Pin Overview	14
2.2.1 Restrictions for GPIOs and RTC_GPIOs	17
2.3 Power Supply	18
2.3.1 Power Scheme	18
2.3.2 Chip Power-up and Reset	18
2.4 Strapping Pins	20
2.5 Pin Mapping Between Chip and Flash/PSRAM	22
<b>3 Functional Description</b>	24
3.1 CPU and Memory	24
3.1.1 CPU	24
3.1.2 Internal Memory	24
3.1.3 External Flash and RAM	25
3.1.4 Address Mapping Structure	25
3.1.5 Cache	27
3.2 System Clocks	27
3.2.1 CPU Clock	27
3.2.2 RTC Clock	27
3.2.3 Audio PLL Clock	28
3.3 RTC and Low-power Management	29
3.3.1 Power Management Unit (PMU)	29
3.3.2 Ultra-Low-Power Coprocessor	30
3.4 Timers and Watchdogs	30
3.4.1 General Purpose Timers	30
3.4.2 Watchdog Timers	30
3.5 Cryptographic Hardware Accelerators	31

3.6	Radio and Wi-Fi	31
3.6.1	2.4 GHz Receiver	31
3.6.2	2.4 GHz Transmitter	31
3.6.3	Clock Generator	32
3.6.4	Wi-Fi Radio and Baseband	32
3.6.5	Wi-Fi MAC	32
3.7	Bluetooth	33
3.7.1	Bluetooth Radio and Baseband	33
3.7.2	Bluetooth Interface	33
3.7.3	Bluetooth Stack	34
3.7.4	Bluetooth Link Controller	34
3.8	Digital Peripherals	35
3.8.1	General Purpose Input / Output Interface (GPIO)	35
3.8.2	Serial Peripheral Interface (SPI)	35
3.8.3	Universal Asynchronous Receiver Transmitter (UART)	35
3.8.4	I2C Interface	35
3.8.5	I2S Interface	36
3.8.6	Remote Control Peripheral	36
3.8.7	Pulse Counter	36
3.8.8	LED PWM Controller	36
3.8.9	Motor Control PWM	37
3.8.10	SD/SDIO/MMC Host Controller	37
3.8.11	SDIO/SPI Slave Controller	37
3.8.12	TWAI® Controller	37
3.8.13	Ethernet MAC Interface	38
3.9	Analog Peripherals	38
3.9.1	Analog-to-Digital Converter (ADC)	38
3.9.2	Digital-to-Analog Converter (DAC)	39
3.9.3	Touch Sensor	40
3.10	Peripheral Pin Configurations	41
<b>4</b>	<b>Electrical Characteristics</b>	<b>46</b>
4.1	Absolute Maximum Ratings	46
4.2	Recommended Power Supply Characteristics	46
4.3	DC Characteristics (3.3 V, 25 °C)	47
4.4	RF Current Consumption in Active Mode	47
4.5	Reliability	48
4.6	Wi-Fi Radio	48
4.7	Bluetooth Radio	49
4.7.1	Receiver –Basic Data Rate	49
4.7.2	Transmitter –Basic Data Rate	49
4.7.3	Receiver –Enhanced Data Rate	50
4.7.4	Transmitter –Enhanced Data Rate	50
4.8	Bluetooth LE Radio	51
4.8.1	Receiver	51
4.8.2	Transmitter	52

<b>5 Packaging</b>	53
<b>Related Documentation and Resources</b>	54
<b>Appendix A –ESP32 Pin Lists</b>	55
A.1. Notes on ESP32 Pin Lists	55
A.2. GPIO_Matrix	57
A.3. Ethernet_MAC	62
A.4. IO_MUX	62
<b>Revision History</b>	64

## List of Tables

1-1	ESP32 Series Comparison	11
2-1	Pin Overview	14
2-2	Description of Timing Parameters for Power-up and Reset	19
2-3	Strapping Pins	20
2-4	Description of Timing Parameters for the Strapping Pins	21
2-5	Pin-to-Pin Mapping Between Chip and In-Package Flash/PSRAM	22
2-6	Pin-to-Pin Mapping Between Chip and Off-Package Flash/PSRAM	22
3-1	Memory and Peripheral Mapping	26
3-2	Power Consumption by Power Modes	29
3-3	ADC Characteristics	39
3-4	ADC Calibration Results	39
3-5	Capacitive-Sensing GPIOs Available on ESP32	40
3-6	Peripheral Pin Configurations	41
4-1	Absolute Maximum Ratings	46
4-2	Recommended Power Supply Characteristics	46
4-3	DC Characteristics (3.3 V, 25 °C)	47
4-4	Current Consumption Depending on RF Modes	47
4-5	Reliability Qualifications	48
4-6	Wi-Fi Radio Characteristics	48
4-7	Receiver Characteristics –Basic Data Rate	49
4-8	Transmitter Characteristics –Basic Data Rate	49
4-9	Receiver Characteristics –Enhanced Data Rate	50
4-10	Transmitter Characteristics –Enhanced Data Rate	50
4-11	Receiver Characteristics –Bluetooth LE	51
4-12	Transmitter Characteristics –Bluetooth LE	52
5-1	Notes on ESP32 Pin Lists	55
5-2	GPIO_Matrix	57
5-3	Ethernet_MAC	62

## List of Figures

1-1	ESP32 Series Nomenclature	11
2-1	ESP32 Pin Layout (QFN 6*6, Top View)	12
2-2	ESP32 Pin Layout (QFN 5*5, Top View)	13
2-3	ESP32 Power Scheme	18
2-4	Visualization of Timing Parameters for Power-up and Reset	19
2-5	Visualization of Timing Parameters for the Strapping Pins	21
3-1	Address Mapping Structure	25
5-1	QFN48 (6×6 mm) Package	53
5-2	QFN48 (5×5 mm) Package	53

# 1 ESP32 Series Comparison

## 1.1 Nomenclature

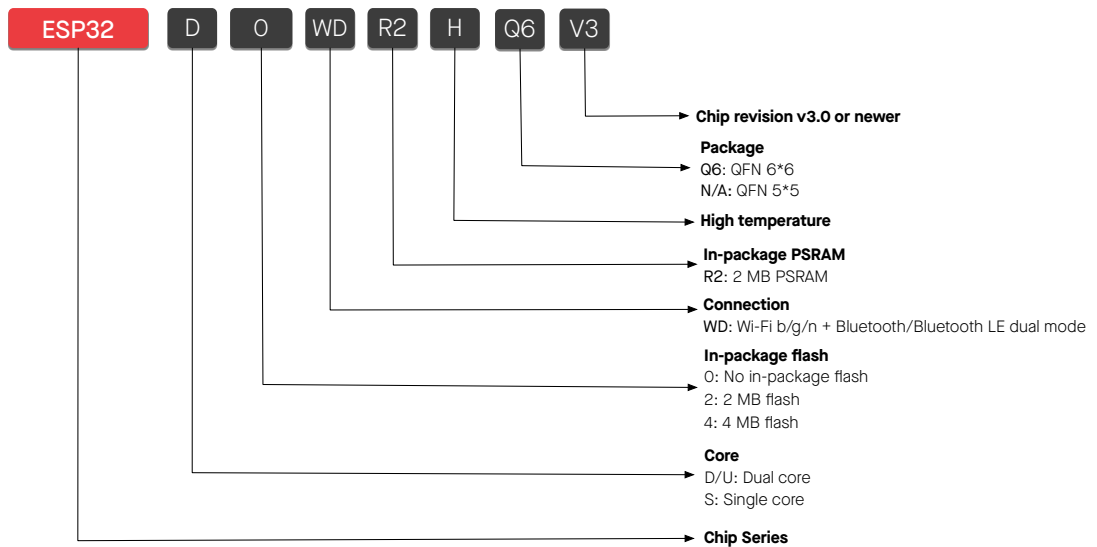

Figure 1-1. ESP32 Series Nomenclature

## 1.2 Comparison

Table 1-1. ESP32 Series Comparison

Ordering code <sup>1</sup>	Core	Chip Revision <sup>2</sup>	In-Package Flash/PSRAM	Package	VDD_SDIO Voltage
ESP32-D0WD-V3	Dual core	v3.0/v3.1 <sup>4</sup>	—	QFN 5*5	1.8 V/3.3 V
ESP32-D0WDR2-V3	Dual core	v3.0/v3.1 <sup>4</sup>	2 MB PSRAM	QFN 5*5	3.3 V
ESP32-U4WDH	Dual core <sup>3</sup>	v3.0/v3.1 <sup>4</sup>	4 MB flash <sup>6</sup>	QFN 5*5	3.3 V
ESP32-D0WDQ6-V3 <a href="#">(NRND)</a>	Dual core	v3.0/v3.1 <sup>4</sup>	—	QFN 6*6	1.8 V/3.3 V
ESP32-D0WD <a href="#">(NRND)</a>	Dual core	v1.0/v1.1 <sup>5</sup>	—	QFN 5*5	1.8 V/3.3 V
ESP32-D0WDQ6 <a href="#">(NRND)</a>	Dual core	v1.0/v1.1 <sup>5</sup>	—	QFN 6*6	1.8 V/3.3 V
ESP32-S0WD <a href="#">(NRND)</a>	Single core	v1.0/v1.1 <sup>5</sup>	—	QFN 5*5	1.8 V/3.3 V

<sup>1</sup> All above chips support Wi-Fi b/g/n + Bluetooth/Bluetooth LE Dual Mode connection. For details on chip marking and packing, see Section 5 [Packaging](#).

<sup>2</sup> Differences between ESP32 chip revisions and how to distinguish them are described in [ESP32 Series SoC Errata](#).

<sup>3</sup> ESP32-U4WDH will be produced as dual-core instead of single core. See [PCN-2021-021](#) for more details.

<sup>4</sup> The chips will be produced with chip revision v3.1 inside. See [PCN20220901](#) for more details.

<sup>5</sup> The chips will be produced with chip revision v1.1 inside. See [PCN20220901](#) for more details.

<sup>6</sup> The in-package flash supports:

- More than 100,000 program/erase cycles
- More than 20 years data retention time

## 2 Pins

### 2.1 Pin Layout

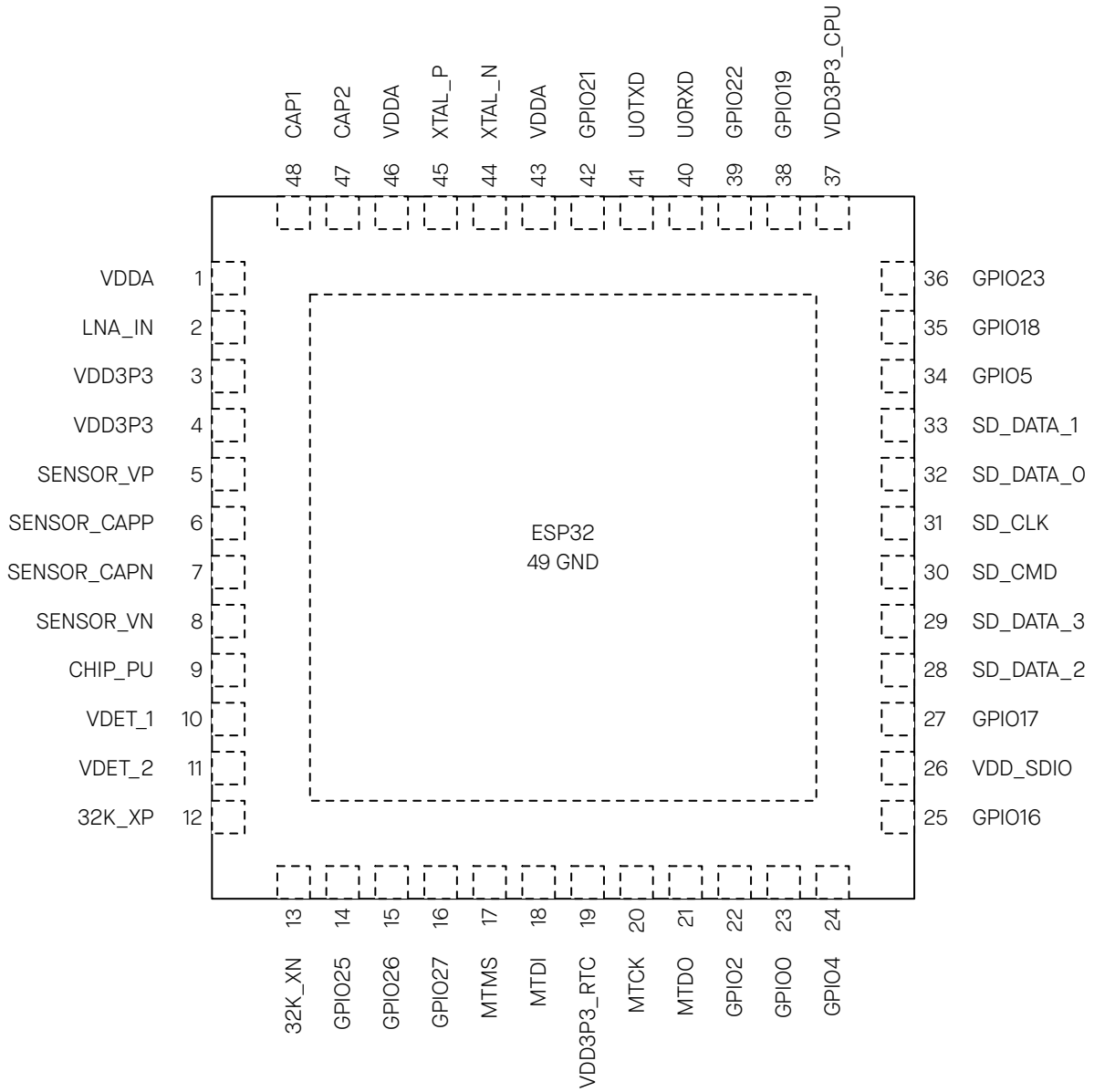

Figure 2-1. ESP32 Pin Layout (QFN 6\*6, Top View)

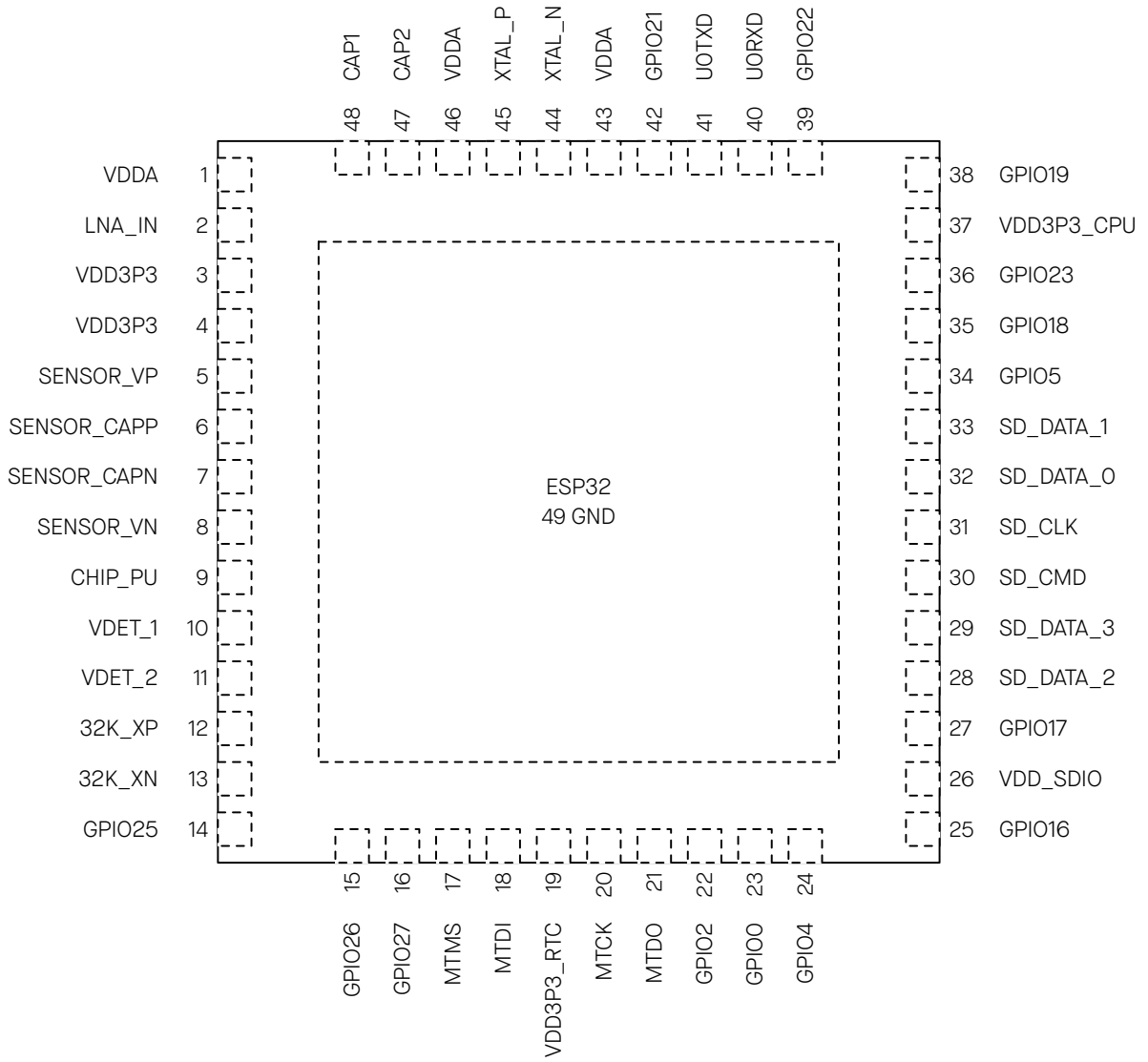

Figure 2-2. ESP32 Pin Layout (QFN 5\*5, Top View)

## 2.2 Pin Overview

Table 2-1. Pin Overview

Name	No.	Type	Function
Analog			
VDDA	1	P	Analog power supply (2.3 V ~ 3.6 V)
LNA_IN	2	I/O	RF input and output
VDD3P3	3	P	Analog power supply (2.3 V ~ 3.6 V)
VDD3P3	4	P	Analog power supply (2.3 V ~ 3.6 V)
VDD3P3_RTC			
SENSOR_VP	5	I	GPIO36, ADC1_CH0, RTC_GPIO0
SENSOR_CAPP	6	I	GPIO37, ADC1_CH1, RTC_GPIO1
SENSOR_CAPN	7	I	GPIO38, ADC1_CH2, RTC_GPIO2
SENSOR_VN	8	I	GPIO39, ADC1_CH3, RTC_GPIO3
CHIP_PU	9	I	High: On; enables the chip Low: Off; the chip shuts down Note: Do not leave the CHIP_PU pin floating.
VDET_1	10	I	GPIO34, ADC1_CH6, RTC_GPIO4
VDET_2	11	I	GPIO35, ADC1_CH7, RTC_GPIO5
32K_XP	12	I/O	GPIO32, ADC1_CH4, RTC_GPIO9, TOUCH9, 32K_XP (32.768 kHz crystal oscillator)
32K_XN	13	I/O	GPIO33, ADC1_CH5, RTC_GPIO8, TOUCH8, 32K_XN (32.768 kHz crystal oscillator)
GPIO25	14	I/O	GPIO25, ADC2_CH8, RTC_GPIO6, DAC_1, EMAC_RXDO
GPIO26	15	I/O	GPIO26, ADC2_CH9, RTC_GPIO7, DAC_2, EMAC_RXD1
GPIO27	16	I/O	GPIO27, ADC2_CH7, RTC_GPIO17, TOUCH7, EMAC_RX_DV
MTMS	17	I/O	GPIO14, ADC2_CH6, RTC_GPIO16, TOUCH6, EMAC_TXD2, HSPICLK, H
MTDI	18	I/O	GPIO12, ADC2_CH5, RTC_GPIO15, TOUCH5, EMAC_TXD3, HSPIQ, H
VDD3P3_RTC	19	P	Input power supply for RTC IO (2.3 V ~ 3.6 V)
MTCK	20	I/O	GPIO13, ADC2_CH4, RTC_GPIO14, TOUCH4, EMAC_RX_ER, HSPID, H
MTDO	21	I/O	GPIO15, ADC2_CH3, RTC_GPIO13, TOUCH3, EMAC_RXD3, HSPICSO, H

Name	No.	Type	Function
GPIO2	22	I/O	GPIO2, ADC2_CH2, RTC_GPIO12, TOUCH2, HSPiWP,
GPIO0	23	I/O	GPIO0, ADC2_CH1, RTC_GPIO11, TOUCH1, EMAC_TX_CLK, CLK_OUT1,
GPIO4	24	I/O	GPIO4, ADC2_CHO, RTC_GPIO10, TOUCH0, EMAC_TX_ER, HSPiHD,
VDD_SDIO			
GPIO16	25	I/O	GPIO16, HS1_DATA4, U2RXD, EMAC_CLK_OUT
VDD_SDIO	26	P	Output power supply: 1.8 V or the same voltage as VDD3P3_RTC
GPIO17	27	I/O	GPIO17, HS1_DATA5, U2TXD, EMAC_CLK_OUT_180
SD_DATA_2	28	I/O	GPIO9, HS1_DATA2, U1RXD, SD_DATA2, SPIHD
SD_DATA_3	29	I/O	GPIO10, HS1_DATA3, U1TXD, SD_DATA3, SPiWP
SD_CMD	30	I/O	GPIO11, HS1_CMD, U1RTS, SD_CMD, SPiCSO
SD_CLK	31	I/O	GPIO6, HS1_CLK, U1CTS, SD_CLK, SPiCLK
SD_DATA_0	32	I/O	GPIO7, HS1_DATA0, U2RTS, SD_DATA0, SPiQ
SD_DATA_1	33	I/O	GPIO8, HS1_DATA1, U2CTS, SD_DATA1, SPiD
VDD3P3_CPU			
GPIO5	34	I/O	GPIO5, HS1_DATA6, VSPiCSO, EMAC_RX_CLK
GPIO18	35	I/O	GPIO18, HS1_DATA7, VSPiCLK
GPIO23	36	I/O	GPIO23, HS1_STROBE, VSPiD
VDD3P3_CPU	37	P	Input power supply for CPU IO (1.8 V ~ 3.6 V)
GPIO19	38	I/O	GPIO19, UOCTS, VSPiQ, EMAC_TXDO
GPIO22	39	I/O	GPIO22, UORTS, VSPiWP, EMAC_TXD1
UORXD	40	I/O	GPIO3, UORXD, CLK_OUT2
UOTXD	41	I/O	GPIO1, UOTXD, CLK_OUT3, EMAC_RXD2
GPIO21	42	I/O	GPIO21, VSPiHD, EMAC_TX_EN
Analog			
VDDA	43	P	Analog power supply (2.3 V ~ 3.6 V)
XTAL_N	44	O	External crystal output
XTAL_P	45	I	External crystal input
VDDA	46	P	Analog power supply (2.3 V ~ 3.6 V)
CAP2	47	I	Connects to a 3.3 nF (10%) capacitor and 20 kΩ resistor in parallel to CAP1

Name	No.	Type	Function
CAP1	48	I	Connects to a 10 nF series capacitor to ground
<b>GND</b>	49	P	Ground

Regarding highlighted cells, see Section [2.2.1 Restrictions for GPIOs and RTC\\_GPIOs](#).

For a quick reference guide to using the IO\_MUX, Ethernet MAC, and GPIO Matrix pins of ESP32, please refer to Appendix

## 2.2.1 Restrictions for GPIOs and RTC\_GPIOs

All IO pins of the ESP32 have GPIO and some have RTC\_GPIO pin functions. However, these IO pins are multifunctional and can be configured for different purposes based on the requirements. Some IOs have restrictions for usage. It is essential to consider their multiplexed nature and the limitations when using these IO pins.

In Table [2-1 Pin Overview](#) some pin functions are highlighted, specifically:

- **GPIO** – **Input only pins**, output is not supported due to lack of pull-up/pull-down resistors.
- **GPIO** – allocated for communication with in-package flash/PSRAM and NOT recommended for other uses. For details, see Section [2.5 Pin Mapping Between Chip and Flash/PSRAM](#).
- **GPIO** – have one of the following important functions:
  - **Strapping pins** – need to be at certain logic levels at startup. See Section [2.4 Strapping Pins](#).
  - **JTAG interface** – often used for debugging.
  - **UART interface** – often used for debugging.

See also [Appendix A.1 – Notes on ESP32 Pin Lists](#).

## 2.3 Power Supply

ESP32's digital pins are divided into three different power domains:

- VDD3P3\_RTC
- VDD3P3\_CPU
- VDD\_SDIO

VDD3P3\_RTC is also the input power supply for RTC and CPU.

VDD3P3\_CPU is also the input power supply for CPU.

VDD\_SDIO connects to the output of an internal LDO whose input is VDD3P3\_RTC. When VDD\_SDIO is connected to the same PCB net together with VDD3P3\_RTC, the internal LDO is disabled automatically.

### 2.3.1 Power Scheme

The power scheme is shown in Figure 2-3 ESP32 Power Scheme.

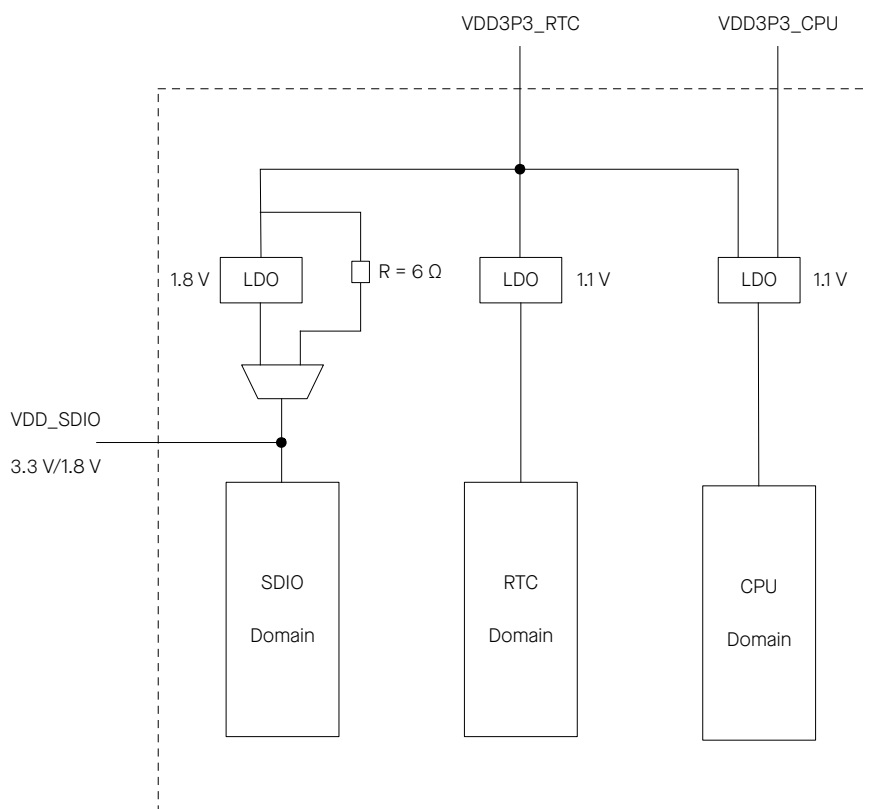

Figure 2-3. ESP32 Power Scheme

The internal LDO can be configured as having 1.8 V, or the same voltage as VDD3P3\_RTC. It can be powered off via software to minimize the current of flash/SRAM during the Deep-sleep mode.

### 2.3.2 Chip Power-up and Reset

Once the power is supplied to the chip, its power rails need a short time to stabilize. After that, CHIP\_PU – the pin used for power-up and reset – is pulled high to activate the chip. For information on CHIP\_PU as well as

power-up and reset timing, see Figure 2-4 and Table 2-2.

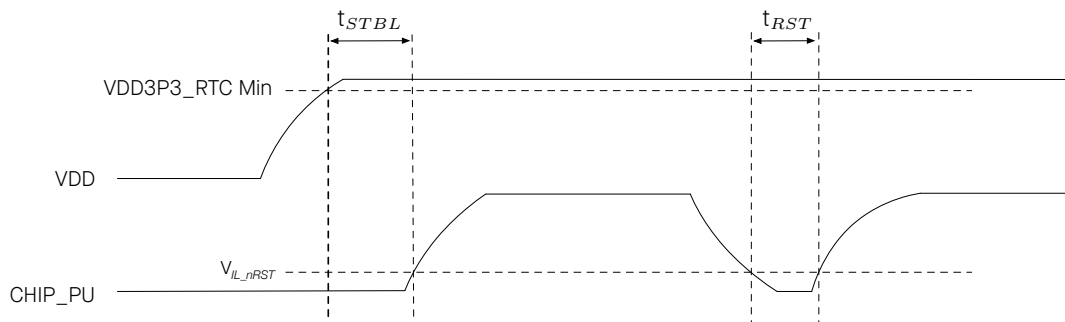

Figure 2-4. Visualization of Timing Parameters for Power-up and Reset

Table 2-2. Description of Timing Parameters for Power-up and Reset

Parameter	Description	Min ( $\mu\text{s}$ )
$t_{STBL}$	Time reserved for the 3.3 V rails to stabilize before the CHIP_PU pin is pulled high to activate the chip	50
$t_{RST}$	Time reserved for CHIP_PU to stay below $V_{IL\_nRST}$ to reset the chip (see Table 4-3)	50

- In scenarios where ESP32 is powered up and down repeatedly by switching the power rails, while there is a large capacitor on the VDD33 rail and CHIP\_PU and VDD33 are connected, simply switching off the CHIP\_PU power rail and immediately switching it back on may cause an incomplete power discharge cycle and failure to reset the chip adequately. An additional discharge circuit may be required to accelerate the discharge of the large capacitor on rail VDD33, which will ensure proper power-on-reset when the ESP32 is powered up again.
- When a battery is used as the power supply for the ESP32 series of chips and modules, a supply voltage supervisor is recommended, so that a boot failure due to low voltage is avoided. Users are recommended to pull CHIP\_PU low if the power supply for ESP32 is below 2.3 V.

#### Notes on power supply:

- The operating voltage of ESP32 ranges from 2.3 V to 3.6 V. When using a single-power supply, the recommended voltage of the power supply is 3.3 V, and its recommended output current is 500 mA or more.
- PSRAM and flash both are powered by VDD\_SDIO. If the chip has an in-package flash, the voltage of VDD\_SDIO is determined by the operating voltage of the in-package flash. If the chip also connects to an external PSRAM, the operating voltage of external PSRAM must match that of the in-package flash. This also applies if the chip has an in-package PSRAM but also connects to an external flash.
- When VDD\_SDIO 1.8 V is used as the power supply for external flash/PSRAM, a 2 k $\Omega$  grounding resistor should be added to VDD\_SDIO. For the circuit design, please refer to [ESP32 Hardware Design Guidelines](#).
- When the three digital power supplies are used to drive peripherals, e.g., 3.3 V flash, they should comply with the peripherals' specifications.

## 2.4 Strapping Pins

There are five strapping pins:

- MTDI
- GPIO0
- GPIO2
- MTDO
- GPIO5

Software can read the values of these five bits from register "GPIO\_STRAPPING".

During the chip's system reset release (power-on-reset, RTC watchdog reset and brownout reset), the latches of the strapping pins sample the voltage level as strapping bits of "0" or "1", and hold these bits until the chip is powered down or shut down. The strapping bits configure the device's boot mode, the operating voltage of VDD\_SDIO and other initial system settings.

Each strapping pin is connected to its internal pull-up/pull-down during the chip reset. Consequently, if a strapping pin is unconnected or the connected external circuit is high-impedance, the internal weak pull-up/pull-down will determine the default input level of the strapping pins.

To change the strapping bit values, users can apply the external pull-down/pull-up resistances, or use the host MCU's GPIOs to control the voltage level of these pins when powering on the chip.

After reset release, the strapping pins work as normal-function pins.

Refer to Table 2-3 for a detailed boot-mode configuration by strapping pins.

**Table 2-3. Strapping Pins**

Voltage of Internal LDO (VDD_SDIO)					
Pin	Default	3.3 V		1.8 V	
MTDI	Pull-down	0		1	
Bootling Mode					
Pin	Default	SPI Boot		Download Boot	
GPIO0	Pull-up	1		0	
GPIO2	Pull-down	Don't-care		0	
Enabling/Disabling Debugging Log Print over UOTXD During Bootling					
Pin	Default	UOTXD Active		UOTXD Silent	
MTDO	Pull-up	1		0	
Timing of SDIO Slave					
Pin	Default	FE Sampling FE Output	FE Sampling RE Output	RE Sampling FE Output	RE Sampling RE Output
MTDO	Pull-up	0	0	1	1
GPIO5	Pull-up	0	1	0	1

**Note:**

- FE: falling-edge, RE: rising-edge.
- Firmware can configure register bits to change the settings of “Voltage of Internal LDO (VDD\_SDIO)” and “Timing of SDIO Slave”, after booting.
- For ESP32 chips that contain an in-package flash or PSRAM, users need to note the logic level of MTDI. For example, ESP32-U4WDH contains an in-package flash that operates at 3.3 V, therefore, the MTDI should be low.

Regarding the timing requirements for the strapping pins, there are such parameters as *setup time* and *hold time*. For more information, see Table 2-4 and Figure 2-5.

**Table 2-4. Description of Timing Parameters for the Strapping Pins**

Parameter	Description	Min (ms)
$t_{SU}$	<i>Setup time</i> is the time reserved for the power rails to stabilize before the CHIP_PU pin is pulled high to activate the chip.	0
$t_H$	<i>Hold time</i> is the time reserved for the chip to read the strapping pin values after CHIP_PU is already high and before these pins start operating as regular IO pins.	1

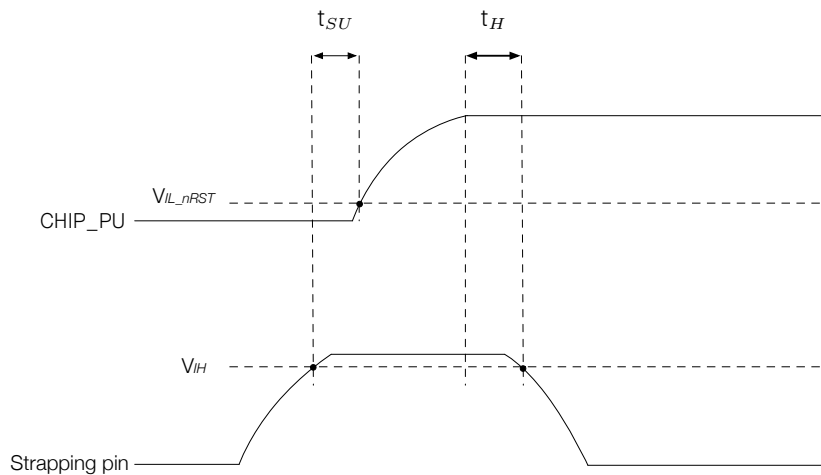

**Figure 2-5. Visualization of Timing Parameters for the Strapping Pins**

## 2.5 Pin Mapping Between Chip and Flash/PSRAM

Table 2-5 lists the pin-to-pin mapping between the chip and the in-package flash/PSRAM. The chip pins listed here are not recommended for other usage.

For the data port connection between ESP32 and off-package flash/PSRAM please refer to Table 2-6.

Table 2-5. Pin-to-Pin Mapping Between Chip and In-Package Flash/PSRAM

ESP32-U4WDH	In-Package Flash (4 MB)
SD_DATA_1	I00/DI
GPIO17	I01/DO
SD_DATA_0	I02/WP#
SD_CMD	I03/HOLD#
SD_CLK	CLK
GPIO16	CS#
GND	VSS
VDD_SDIO <sup>1</sup>	VDD
ESP32-D0WDR2-V3	In-Package PSRAM (2 MB)
SD_DATA_1	SIO0/SI
SD_DATA_0	SIO1/SO
SD_DATA_3	SIO2
SD_DATA_2	SIO3
SD_CLK	SCLK
GPIO16 <sup>2</sup>	CE#
GND	VSS
VDD_SDIO <sup>1</sup>	VDD

Table 2-6. Pin-to-Pin Mapping Between Chip and Off-Package Flash/PSRAM

Chip Pin	Off-Package Flash
SD_DATA_1/SPID	I00/DI
SD_DATA_0/SPIQ	I01/DO
SD_DATA_3/SPIWP	I02/WP#
SD_DATA_2/SPIHD	I03/HOLD#
SD_CLK	CLK
SD_CMD	CS#
GND	VSS
VDD_SDIO	VDD
Chip Pin	Off-Package PSRAM
SD_DATA_1	SIO0/SI
SD_DATA_0	SIO1/SO
SD_DATA_3	SIO2
SD_DATA_2	SIO3
SD_CLK/GPIO17 <sup>3</sup>	SCLK

Cont'd on next page

Table 2-6 – cont'd from previous page

Chip Pin	Off-Package PSRAM
GPIO16 <sup>2</sup>	CE#
GND	VSS
VDD_SDIO	VDD

**Note:**

1. As the in-package flash/PSRAM in ESP32-U4WDH/ESP32-D0WDR2-V3 operates at 3.3 V, VDD\_SDIO must be powered by VDD3P3\_RTC via a 6  $\Omega$  resistor. See Figure [2-3 ESP32 Power Scheme](#).
2. If GPIO16 is used to connect to PSRAM's CE# signal, please add a pull-up resistor at the GPIO16 pin. See [ESP32-WROVER-E Datasheet](#) > Figure *Schematics of ESP32-WROVER-E*.
3. SD\_CLK and GPIO17 pins are available to connect to the SCLK signal of external PSRAM.
  - If SD\_CLK pin is selected, one GPIO (i.e., GPIO17) will be saved. The saved GPIO can be used for other purposes. This connection has passed internal tests, but relevant certification has not been completed.
  - Or GPIO17 pin is used to connect to the SCLK signal. This connection has passed relevant certification, see [certificates for ESP32-WROVER-E](#).

Please select the proper pin for your specific applications.

## 3 Functional Description

### 3.1 CPU and Memory

#### 3.1.1 CPU

ESP32 contains one or two low-power Xtensa® 32-bit LX6 microprocessor(s) with the following features:

- 7-stage pipeline to support the clock frequency of up to 240 MHz (160 MHz for ESP32-S0WD [\(NRND\)](#))
- 16/24-bit Instruction Set provides high code-density
- Support for Floating Point Unit
- Support for DSP instructions, such as a 32-bit multiplier, a 32-bit divider, and a 40-bit MAC
- Support for 32 interrupt vectors from about 70 interrupt sources

The single-/dual-CPU interfaces include:

- Xtensa RAM/ROM Interface for instructions and data
- Xtensa Local Memory Interface for fast peripheral register access
- External and internal interrupt sources
- JTAG for debugging

For information about the Xtensa® Instruction Set Architecture, please refer to [Xtensa® Instruction Set Architecture \(ISA\) Summary](#).

#### 3.1.2 Internal Memory

ESP32's internal memory includes:

- 448 KB of ROM for booting and core functions
- 520 KB of on-chip SRAM for data and instructions
- 8 KB of SRAM in RTC, which is called RTC FAST Memory and can be used for data storage; it is accessed by the main CPU during RTC Boot from the Deep-sleep mode.
- 8 KB of SRAM in RTC, which is called RTC SLOW Memory and can be accessed by the ULP coprocessor during the Deep-sleep mode.
- 1 Kbit of eFuse: 256 bits are used for the system (MAC address and chip configuration) and the remaining 768 bits are reserved for customer applications, including flash-encryption and chip-ID.
- In-package flash or PSRAM

**Note:**

Products in the ESP32 series differ from each other, in terms of their support for in-package flash or PSRAM and the size of them. For details, please refer to [Section 1 ESP32 Series Comparison](#).

### 3.1.3 External Flash and RAM

ESP32 supports multiple external QSPI flash and external RAM (SRAM) chips. More details can be found in [ESP32 Technical Reference Manual](#) > Chapter *SPI Controller*. ESP32 also supports hardware encryption/decryption based on AES to protect developers' programs and data in flash.

ESP32 can access the external QSPI flash and SRAM through high-speed caches.

- Up to 16 MB of external flash can be mapped into CPU instruction memory space and read-only memory space simultaneously.
  - When external flash is mapped into CPU instruction memory space, up to 11 MB + 248 KB can be mapped at a time. Note that if more than 3 MB + 248 KB are mapped, cache performance will be reduced due to speculative reads by the CPU.
  - When external flash is mapped into read-only data memory space, up to 4 MB can be mapped at a time. 8-bit, 16-bit and 32-bit reads are supported.
- External RAM can be mapped into CPU data memory space. SRAM up to 8 MB is supported and up to 4 MB can be mapped at a time. 8-bit, 16-bit and 32-bit reads and writes are supported.

**Note:**

After ESP32 is initialized, firmware can customize the mapping of external RAM or flash into the CPU address space.

### 3.1.4 Address Mapping Structure

The structure of address mapping is shown in Figure 3-1. The memory and peripheral mapping is shown in Table 3-1.

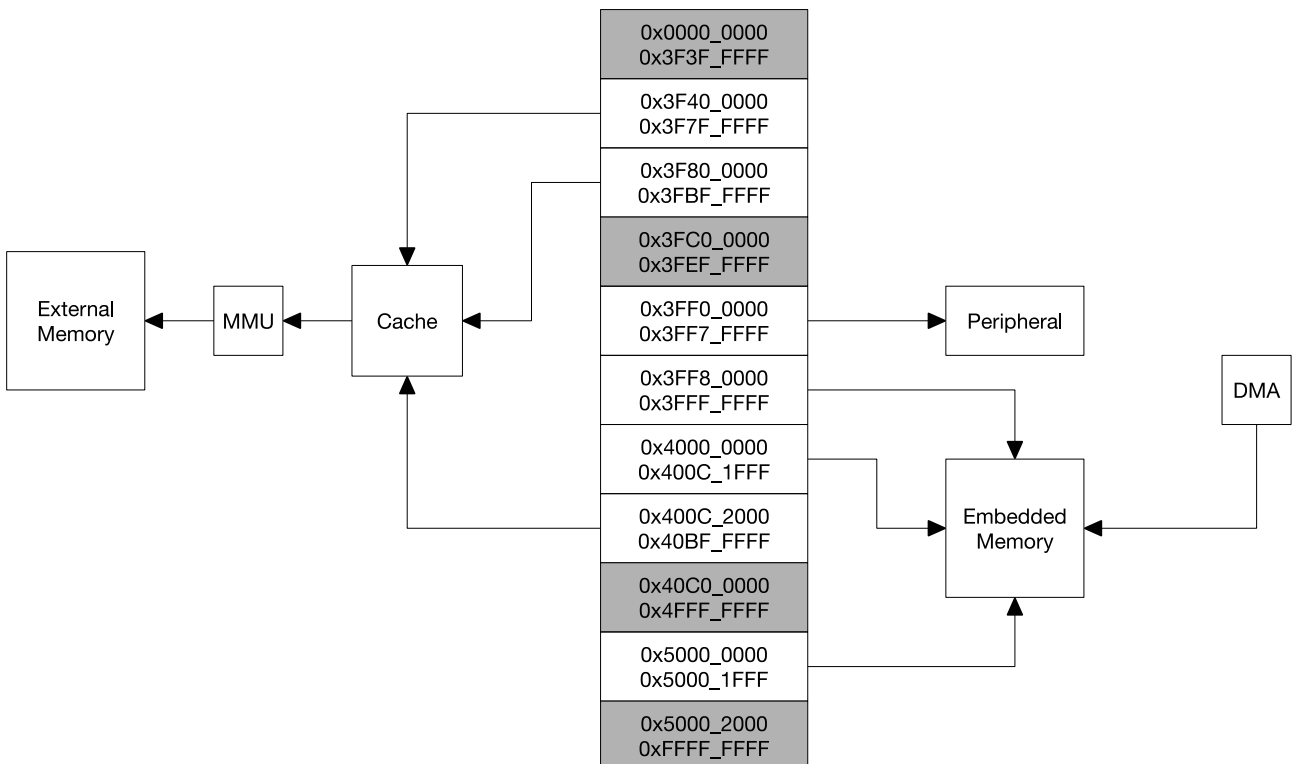

Figure 3-1. Address Mapping Structure

Table 3-1. Memory and Peripheral Mapping

Category	Target	Start Address	End Address	Size
Embedded Memory	Internal ROM 0	0x4000_0000	0x4005_FFFF	384 KB
	Internal ROM 1	0x3FF9_0000	0x3FF9_FFFF	64 KB
	Internal SRAM 0	0x4007_0000	0x4009_FFFF	192 KB
	Internal SRAM 1	0x3FFE_0000	0x3FFF_FFFF	128 KB
		0x400A_0000	0x400B_FFFF	
	Internal SRAM 2	0x3FFA_E000	0x3FFD_FFFF	200 KB
	RTC FAST Memory	0x3FF8_0000	0x3FF8_1FFF	8 KB
0x400C_0000		0x400C_1FFF		
RTC SLOW Memory	0x5000_0000	0x5000_1FFF	8 KB	
External Memory	External Flash	0x3F40_0000	0x3F7F_FFFF	4 MB
		0x400C_2000	0x40BF_FFFF	11 MB+248 KB
	External RAM	0x3F80_0000	0x3FBF_FFFF	4 MB
Peripheral	DPort Register	0x3FF0_0000	0x3FF0_OFFF	4 KB
	AES Accelerator	0x3FF0_1000	0x3FF0_1FFF	4 KB
	RSA Accelerator	0x3FF0_2000	0x3FF0_2FFF	4 KB
	SHA Accelerator	0x3FF0_3000	0x3FF0_3FFF	4 KB
	Secure Boot	0x3FF0_4000	0x3FF0_4FFF	4 KB
	Cache MMU Table	0x3FF1_0000	0x3FF1_3FFF	16 KB
	PID Controller	0x3FF1_F000	0x3FF1_FFFF	4 KB
	UART0	0x3FF4_0000	0x3FF4_OFFF	4 KB
	SPI1	0x3FF4_2000	0x3FF4_2FFF	4 KB
	SPIO	0x3FF4_3000	0x3FF4_3FFF	4 KB
	GPIO	0x3FF4_4000	0x3FF4_4FFF	4 KB
	RTC	0x3FF4_8000	0x3FF4_8FFF	4 KB
	IO MUX	0x3FF4_9000	0x3FF4_9FFF	4 KB
	SDIO Slave	0x3FF4_B000	0x3FF4_BFFF	4 KB
	UDMA1	0x3FF4_C000	0x3FF4_CFFF	4 KB
	I2S0	0x3FF4_F000	0x3FF4_FFFF	4 KB
	UART1	0x3FF5_0000	0x3FF5_OFFF	4 KB
	I2C0	0x3FF5_3000	0x3FF5_3FFF	4 KB
	UDMA0	0x3FF5_4000	0x3FF5_4FFF	4 KB
	SDIO Slave	0x3FF5_5000	0x3FF5_5FFF	4 KB
	RMT	0x3FF5_6000	0x3FF5_6FFF	4 KB
	PCNT	0x3FF5_7000	0x3FF5_7FFF	4 KB
	SDIO Slave	0x3FF5_8000	0x3FF5_8FFF	4 KB
	LED PWM	0x3FF5_9000	0x3FF5_9FFF	4 KB
	eFuse Controller	0x3FF5_A000	0x3FF5_AFFF	4 KB
	Flash Encryption	0x3FF5_B000	0x3FF5_BFFF	4 KB
	PWM0	0x3FF5_E000	0x3FF5_EFFF	4 KB
	TIMGO	0x3FF5_F000	0x3FF5_FFFF	4 KB
	TIMG1	0x3FF6_0000	0x3FF6_OFFF	4 KB
	SPI2	0x3FF6_4000	0x3FF6_4FFF	4 KB
	SPI3	0x3FF6_5000	0x3FF6_5FFF	4 KB

Category	Target	Start Address	End Address	Size
Peripheral	SYSCON	0×3FF6_6000	0×3FF6_6FFF	4 KB
	I2C1	0×3FF6_7000	0×3FF6_7FFF	4 KB
	SDMMC	0×3FF6_8000	0×3FF6_8FFF	4 KB
	EMAC	0×3FF6_9000	0×3FF6_AFFF	8 KB
	TWAI	0×3FF6_B000	0×3FF6_BFFF	4 KB
	PWM1	0×3FF6_C000	0×3FF6_CFFF	4 KB
	I2S1	0×3FF6_D000	0×3FF6_DFFF	4 KB
	UART2	0×3FF6_E000	0×3FF6_EFFF	4 KB
	PWM2	0×3FF6_F000	0×3FF6_FFFF	4 KB
	PWM3	0×3FF7_0000	0×3FF7_0FFF	4 KB
	RNG	0×3FF7_5000	0×3FF7_5FFF	4 KB

### 3.1.5 Cache

ESP32 uses a two-way set-associative cache. Each of the two CPUs has 32 KB of cache featuring a block size of 32 bytes for accessing external storage.

For details, see [ESP32 Technical Reference Manual](#) > Chapter System and Memory > Section Cache.

## 3.2 System Clocks

### 3.2.1 CPU Clock

Upon reset, an external crystal clock source is selected as the default CPU clock. The external crystal clock source also connects to a PLL to generate a high-frequency clock (typically 160 MHz).

In addition, ESP32 has an internal 8 MHz oscillator. The application can select the clock source from the external crystal clock source, the PLL clock or the internal 8 MHz oscillator. The selected clock source drives the CPU clock directly, or after division, depending on the application.

### 3.2.2 RTC Clock

The RTC clock has five possible sources:

- external low-speed (32 kHz) crystal clock
- external crystal clock divided by 4
- internal RC oscillator (typically about 150 kHz, and adjustable)
- internal 8 MHz oscillator
- internal 31.25 kHz clock (derived from the internal 8 MHz oscillator divided by 256)

When the chip is in the normal power mode and needs faster CPU accessing, the application can choose the external high-speed crystal clock divided by 4 or the internal 8 MHz oscillator. When the chip operates in the low-power mode, the application chooses the external low-speed (32 kHz) crystal clock, the internal RC clock or the internal 31.25 kHz clock.

### 3.2.3 Audio PLL Clock

The audio clock is generated by the ultra-low-noise fractional-N PLL.

For details, see [ESP32 Technical Reference Manual](#) > Chapter *Reset and Clock*.

## 3.3 RTC and Low-power Management

### 3.3.1 Power Management Unit (PMU)

With the use of advanced power-management technologies, ESP32 can switch between different power modes.

- Power modes
  - **Active mode:** The chip radio is powered up. The chip can receive, transmit, or listen.
  - **Modem-sleep mode:** The CPU is operational and the clock is configurable. The Wi-Fi/Bluetooth baseband and radio are disabled.
  - **Light-sleep mode:** The CPU is paused. The RTC memory and RTC peripherals, as well as the ULP coprocessor are running. Any wake-up events (MAC, SDIO host, RTC timer, or external interrupts) will wake up the chip.
  - **Deep-sleep mode:** Only the RTC memory and RTC peripherals are powered up. Wi-Fi and Bluetooth connection data are stored in the RTC memory. The ULP coprocessor is functional.
  - **Hibernation mode:** The internal 8 MHz oscillator and ULP coprocessor are disabled. The RTC recovery memory is powered down. Only one RTC timer on the slow clock and certain RTC GPIOs are active. The RTC timer or the RTC GPIOs can wake up the chip from the Hibernation mode.

**Table 3-2. Power Consumption by Power Modes**

Power mode	Description		Power Consumption	
Active (RF working)	Wi-Fi Tx packet		Please refer to Table 4-4 for details.	
	Wi-Fi/BT Tx packet			
	Wi-Fi/BT Rx and listening			
Modem-sleep	The CPU is powered up.	240 MHz *	Dual-core chip(s)	30 mA ~ 68 mA
			Single-core chip(s)	N/A
		160 MHz *	Dual-core chip(s)	27 mA ~ 44 mA
			Single-core chip(s)	27 mA ~ 34 mA
		Normal speed: 80 MHz	Dual-core chip(s)	20 mA ~ 31 mA
			Single-core chip(s)	20 mA ~ 25 mA
Light-sleep	-		0.8 mA	
Deep-sleep	The ULP coprocessor is powered up.		150 $\mu$ A	
	ULP sensor-monitored pattern		100 $\mu$ A @1% duty	
	RTC timer + RTC memory		10 $\mu$ A	
Hibernation	RTC timer only		5 $\mu$ A	
Power off	CHIP_PU is set to low level, the chip is powered down.		1 $\mu$ A	

- \* Among the ESP32 series of SoCs, ESP32-D0WD-V3, ESP32-D0WDR2-V3, ESP32-U4WDH, ESP32-D0WD ([NRND](#)), ESP32-D0WDQ6 ([NRND](#)), and ESP32-D0WDQ6-V3 ([NRND](#)) have a maximum CPU frequency of 240 MHz, ESP32-S0WD ([NRND](#)) has a maximum CPU frequency of 160 MHz.
- When Wi-Fi is enabled, the chip switches between Active and Modem-sleep modes. Therefore, power consumption changes accordingly.
- In Modem-sleep mode, the CPU frequency changes automatically. The frequency depends on the CPU load and the peripherals used.

- During Deep-sleep, when the ULP coprocessor is powered on, peripherals such as GPIO and RTC I2C are able to operate.
- When the system works in the ULP sensor-monitored pattern, the ULP coprocessor works with the ULP sensor periodically and the ADC works with a duty cycle of 1%, so the power consumption is 100  $\mu$ A.

### 3.3.2 Ultra-Low-Power Coprocessor

The ULP coprocessor and RTC memory remain powered on during the Deep-sleep mode. Hence, the developer can store a program for the ULP coprocessor in the RTC slow memory to access the peripheral devices, internal timers and internal sensors during the Deep-sleep mode. This is useful for designing applications where the CPU needs to be woken up by an external event, or a timer, or a combination of the two, while maintaining minimal power consumption.

For details, see [ESP32 Technical Reference Manual](#) > Chapter *ULP Coprocessor*.

## 3.4 Timers and Watchdogs

### 3.4.1 General Purpose Timers

There are four general-purpose timers embedded in the chip. They are all 64-bit generic timers which are based on 16-bit prescalers and 64-bit auto-reload-capable up/down-timers.

The timers feature:

- A 16-bit clock prescaler, from 2 to 65536
- A 64-bit timer
- Configurable up/down timer: incrementing or decrementing
- Halt and resume of time-base counter
- Auto-reload at alarming
- Software-controlled instant reload
- Level and edge interrupt generation

For details, see [ESP32 Technical Reference Manual](#) > Chapter *Timer Group*.

### 3.4.2 Watchdog Timers

The chip has three watchdog timers: one in each of the two timer modules (called the Main Watchdog Timer, or MWDT) and one in the RTC module (called the RTC Watchdog Timer, or RWDT). These watchdog timers are intended to recover from an unforeseen fault causing the application program to abandon its normal sequence. A watchdog timer has four stages. Each stage may trigger one of three or four possible actions upon the expiry of its programmed time period, unless the watchdog is fed or disabled. The actions are: interrupt, CPU reset, core reset, and system reset. Only the RWDT can trigger the system reset, and is able to reset the entire chip, including the RTC itself. A timeout value can be set for each stage individually.

During flash boot the RWDT and the first MWDT start automatically in order to detect, and recover from, booting problems.

The watchdogs have the following features:

- Four stages, each of which can be configured or disabled separately
- A programmable time period for each stage
- One of three or four possible actions (interrupt, CPU reset, core reset, and system reset) upon the expiry of each stage
- 32-bit expiry counter
- Write protection that prevents the RWDT and MWDT configuration from being inadvertently altered
- SPI flash boot protection  
If the boot process from an SPI flash does not complete within a predetermined time period, the watchdog will reboot the entire system.

For details, see [ESP32 Technical Reference Manual](#) > Chapter *Watchdog Timers*.

## 3.5 Cryptographic Hardware Accelerators

ESP32 is equipped with hardware accelerators of general algorithms, such as AES (FIPS PUB 197), SHA (FIPS PUB 180-4), RSA, and ECC. The chip also supports independent arithmetic, such as large-number modular multiplication and large-number multiplication. The maximum operation length for RSA, ECC, large-number modular multiplication, and large-number multiplication is 4096 bits.

The hardware accelerators greatly improve operation speed and reduce software complexity. They also support code encryption and dynamic decryption, which ensures that code in the flash will not be hacked.

## 3.6 Radio and Wi-Fi

The radio module consists of the following blocks:

- 2.4 GHz receiver
- 2.4 GHz transmitter
- bias and regulators
- balun and transmit-receive switch
- clock generator

### 3.6.1 2.4 GHz Receiver

The 2.4 GHz receiver demodulates the 2.4 GHz RF signal to quadrature baseband signals and converts them to the digital domain with two high-resolution, high-speed ADCs. To adapt to varying signal channel conditions, RF filters, Automatic Gain Control (AGC), DC offset cancelation circuits and baseband filters are integrated in the chip.

### 3.6.2 2.4 GHz Transmitter

The 2.4 GHz transmitter modulates the quadrature baseband signals to the 2.4 GHz RF signal, and drives the antenna with a high-powered Complementary Metal Oxide Semiconductor (CMOS) power amplifier. The use of digital calibration further improves the linearity of the power amplifier, enabling state-of-the-art performance in

delivering up to +20.5 dBm of power for an 802.11b transmission and +18 dBm for an 802.11n transmission. Additional calibrations are integrated to cancel any radio imperfections, such as:

- Carrier leakage
- I/Q phase matching
- Baseband nonlinearities
- RF nonlinearities
- Antenna matching

These built-in calibration routines reduce the amount of time required for product testing, and render the testing equipment unnecessary.

### 3.6.3 Clock Generator

The clock generator produces quadrature clock signals of 2.4 GHz for both the receiver and the transmitter. All components of the clock generator are integrated into the chip, including all inductors, varactors, filters, regulators and dividers.

The clock generator has built-in calibration and self-test circuits. Quadrature clock phases and phase noise are optimized on-chip with patented calibration algorithms which ensure the best performance of the receiver and the transmitter.

### 3.6.4 Wi-Fi Radio and Baseband

ESP32 implements a TCP/IP and full 802.11 b/g/n Wi-Fi MAC protocol. It supports the Basic Service Set (BSS) STA and SoftAP operations under the Distributed Control Function (DCF). Power management is handled with minimal host interaction to minimize the active-duty period.

The ESP32 Wi-Fi Radio and Baseband support the following features:

- 802.11b/g/n
- 802.11n MCS0-7 in both 20 MHz and 40 MHz bandwidth
- 802.11n MCS32 (RX)
- 802.11n 0.4  $\mu$ s guard-interval
- up to 150 Mbps of data rate
- Receiving STBC 2×1
- Up to 20.5 dBm of transmitting power
- Adjustable transmitting power
- Antenna diversity  
ESP32 supports antenna diversity with an external RF switch. One or more GPIOs control the RF switch and selects the best antenna to minimize the effects of channel fading.

### 3.6.5 Wi-Fi MAC

The ESP32 Wi-Fi MAC applies low-level protocol functions automatically. They are as follows:

- Four virtual Wi-Fi interfaces

- Simultaneous Infrastructure BSS Station mode/SoftAP mode/Promiscuous mode
- RTS protection, CTS protection, Immediate Block ACK
- Defragmentation
- TX/RX A-MPDU, RX A-MSDU
- TXOP
- WMM
- CCMP (CBC-MAC, counter mode), TKIP (MIC, RC4), WAPI (SMS4), WEP (RC4) and CRC
- Automatic beacon monitoring (hardware TSF)

## 3.7 Bluetooth

The chip integrates a Bluetooth link controller and Bluetooth baseband, which carry out the baseband protocols and other low-level link routines, such as modulation/demodulation, packet processing, bit stream processing, frequency hopping, etc.

### 3.7.1 Bluetooth Radio and Baseband

The Bluetooth Radio and Baseband support the following features:

- Class-1, class-2 and class-3 transmit output powers, and a dynamic control range of up to 21 dB
- $\pi/4$  DQPSK and 8 DPSK modulation
- High performance in NZIF receiver sensitivity with a minimum sensitivity of -94 dBm
- Class-1 operation without external PA
- Internal SRAM allows full-speed data-transfer, mixed voice and data, and full piconet operation
- Logic for forward error correction, header error control, access code correlation, CRC, demodulation, encryption bit stream generation, whitening and transmit pulse shaping
- ACL, SCO, eSCO, and AFH
- A-law,  $\mu$ -law, and CVSD digital audio CODEC in PCM interface
- SBC audio CODEC
- Power management for low-power applications
- SMP with 128-bit AES

### 3.7.2 Bluetooth Interface

- Provides UART HCI interface, up to 4 Mbps
- Provides SDIO/SPI HCI interface
- Provides PCM/I2S audio interface

### 3.7.3 Bluetooth Stack

The Bluetooth stack of the chip is compliant with the Bluetooth v4.2 BR/EDR and Bluetooth LE specifications.

### 3.7.4 Bluetooth Link Controller

The link controller operates in three major states: standby, connection and sniff. It enables multiple connections, and other operations, such as inquiry, page, and secure simple-pairing, and therefore enables Piconet and Scatternet. Below are the features:

- Classic Bluetooth
  - Device Discovery (inquiry, and inquiry scan)
  - Connection establishment (page, and page scan)
  - Multi-connections
  - Asynchronous data reception and transmission
  - Synchronous links (SCO/eSCO)
  - Master/Slave Switch
  - Adaptive Frequency Hopping and Channel assessment
  - Broadcast encryption
  - Authentication and encryption
  - Secure Simple-Pairing
  - Multi-point and scatternet management
  - Sniff mode
  - Connectionless Slave Broadcast (transmitter and receiver)
  - Enhanced power control
  - Ping
- Bluetooth Low Energy
  - Advertising
  - Scanning
  - Simultaneous advertising and scanning
  - Multiple connections
  - Asynchronous data reception and transmission
  - Adaptive Frequency Hopping and Channel assessment
  - Connection parameter update
  - Data Length Extension
  - Link Layer Encryption

- LE Ping

## 3.8 Digital Peripherals

### 3.8.1 General Purpose Input / Output Interface (GPIO)

ESP32 has 34 GPIO pins which can be assigned various functions by programming the appropriate registers. There are several kinds of GPIOs: digital-only, analog-enabled, capacitive-touch-enabled, etc. Analog-enabled GPIOs and Capacitive-touch-enabled GPIOs can be configured as digital GPIOs.

Most of the digital GPIOs can be configured as internal pull-up or pull-down, or set to high impedance. When configured as an input, the input value can be read through the register. The input can also be set to edge-trigger or level-trigger to generate CPU interrupts. Most of the digital IO pins are bi-directional, non-inverting and tristate, including input and output buffers with tristate control. These pins can be multiplexed with other functions, such as the SDIO, UART, SPI, etc. (More details can be found in the Appendix, Table [IO\\_MUX](#).) For low-power operations, the GPIOs can be set to hold their states.

For details, see [ESP32 Technical Reference Manual](#) > Chapter *IO\_MUX and GPIO Matrix*.

### 3.8.2 Serial Peripheral Interface (SPI)

ESP32 features three SPIs (SPI, HSPI and VSPI) in slave and master modes in 1-line full-duplex and 1/2/4-line half-duplex communication modes. These SPIs also support the following general-purpose SPI features:

- Four modes of SPI transfer format, which depend on the polarity (CPOL) and the phase (CPHA) of the SPI clock
- Up to 80 MHz (The actual speed it can reach depends on the selected pads, PCB tracing, peripheral characteristics, etc.)
- Up to 64-byte FIFO

All SPIs can also be connected to the external flash/SRAM and LCD. Each SPI can be served by DMA controllers.

For details, see [ESP32 Technical Reference Manual](#) > Chapter *SPI Controller*.

### 3.8.3 Universal Asynchronous Receiver Transmitter (UART)

ESP32 has three UART interfaces, i.e., UART0, UART1, and UART2, which provide asynchronous communication (RS232 and RS485) and IrDA support, communicating at a speed of up to 5 Mbps. UART provides hardware management of the CTS and RTS signals and software flow control (XON and XOFF). All of the interfaces can be accessed by the DMA controller or directly by the CPU.

For details, see [ESP32 Technical Reference Manual](#) > Chapter *UART Controller*.

### 3.8.4 I2C Interface

ESP32 has two I2C bus interfaces which can serve as I2C master or slave, depending on the user's configuration. The I2C interfaces support:

- Standard mode (100 Kbit/s)

- Fast mode (400 Kbit/s)
- Up to 5 MHz, yet constrained by SDA pull-up strength
- 7-bit/10-bit addressing mode
- Dual addressing mode

Users can program command registers to control I2C interfaces, so that they have more flexibility.

For details, see [ESP32 Technical Reference Manual](#) > Chapter *I2C Controller*.

### 3.8.5 I2S Interface

Two standard I2S interfaces are available in ESP32. They can be operated in master or slave mode, in full duplex and half-duplex communication modes, and can be configured to operate with an 8-/16-/32-/48-/64-bit resolution as input or output channels. BCK clock frequency, from 10 kHz up to 40 MHz, is supported. When one or both of the I2S interfaces are configured in the master mode, the master clock can be output to the external DAC/CODEC.

Both of the I2S interfaces have dedicated DMA controllers. PDM and BT PCM interfaces are supported.

For details, see [ESP32 Technical Reference Manual](#) > Chapter *I2S Controller*.

### 3.8.6 Remote Control Peripheral

The infrared remote controller supports eight channels of infrared remote transmission and receiving. By programming the pulse waveform, it supports various infrared protocols. Eight channels share a 512 x 32-bit block of memory to store the transmitting or receiving waveform.

For details, see [ESP32 Technical Reference Manual](#) > Chapter *Remote Control Peripheral*.

### 3.8.7 Pulse Counter

The pulse counter captures pulse and counts pulse edges through seven modes. It has eight channels, each of which captures four signals at a time. The four input signals include two pulse signals and two control signals. When the counter reaches a defined threshold, an interrupt is generated.

For details, see [ESP32 Technical Reference Manual](#) > Chapter *Pulse Count Controller*.

### 3.8.8 LED PWM Controller

The LED PWM controller can generate 16 independent channels of digital waveforms with configurable periods and duties.

The 16 channels of digital waveforms operate with an APB clock of 80 MHz. Eight of these channels have the option of using the 8 MHz oscillator clock. Each channel can select a 20-bit timer with configurable counting range, while its accuracy of duty can be up to 16 bits within a 1 ms period.

The software can change the duty immediately. Moreover, each channel automatically supports step-by-step duty increase or decrease, which is useful for the LED RGB color-gradient generator.

For details, see [ESP32 Technical Reference Manual](#) > Chapter *LED PWM Controller*.

### 3.8.9 Motor Control PWM

The Pulse Width Modulation (PWM) controller can be used for driving digital motors and smart lights. The controller consists of PWM timers, the PWM operator and a dedicated capture sub-module. Each timer provides timing in synchronous or independent form, and each PWM operator generates a waveform for one PWM channel. The dedicated capture sub-module can accurately capture events with external timing.

For details, see [ESP32 Technical Reference Manual](#) > Chapter *Motor Control PWM*.

### 3.8.10 SD/SDIO/MMC Host Controller

An SD/SDIO/MMC host controller is available on ESP32, which supports the following features:

- Secure Digital memory (SD mem Version 3.0 and Version 3.01)
- Secure Digital I/O (SDIO Version 3.0)
- Consumer Electronics Advanced Transport Architecture (CE-ATA Version 1.1)
- Multimedia Cards (MMC Version 4.41, eMMC Version 4.5 and Version 4.51)

The controller allows up to 80 MHz clock output in three different data-bus modes: 1-bit, 4-bit, and 8-bit modes. It supports two SD/SDIO/MMC4.41 cards in a 4-bit data-bus mode. It also supports one SD card operating at 1.8 V.

For details, see [ESP32 Technical Reference Manual](#) > Chapter *SD/MMC Host Controller*.

### 3.8.11 SDIO/SPI Slave Controller

ESP32 integrates an SD device interface that conforms to the industry-standard SDIO Card Specification Version 2.0, and allows a host controller to access the SoC, using the SDIO bus interface and protocol. ESP32 acts as the slave on the SDIO bus. The host can access the SDIO-interface registers directly and can access shared memory via a DMA engine, thus maximizing performance without engaging the processor cores.

The SDIO/SPI slave controller supports the following features:

- SPI, 1-bit SDIO, and 4-bit SDIO transfer modes over the full clock range from 0 to 50 MHz
- Configurable sampling and driving clock edge
- Special registers for direct access by host
- Interrupts to host for initiating data transfer
- Automatic loading of SDIO bus data and automatic discarding of padding data
- Block size of up to 512 bytes
- Interrupt vectors between the host and the slave, allowing both to interrupt each other
- Supports DMA for data transfer

For details, see [ESP32 Technical Reference Manual](#) > Chapter *SDIO Slave Controller*.

### 3.8.12 TWAI<sup>®</sup> Controller

ESP32 family has a TWAI<sup>®</sup> controller with the following features:

- compatible with ISO 11898-1 protocol (CAN Specification 2.0)

- standard frame format (11-bit ID) and extended frame format (29-bit ID)
- bit rates:
  - from 25 Kbit/s to 1 Mbit/s in chip revision v0.0/v1.0/v1.1
  - from 12.5 Kbit/s to 1 Mbit/s in chip revision v3.0/v3.1
- multiple modes of operation: Normal, Listen Only, and Self-Test
- 64-byte receive FIFO
- special transmissions: single-shot transmissions and self reception
- acceptance filter (single and dual filter modes)
- error detection and handling: error counters, configurable error interrupt threshold, error code capture, arbitration lost capture

For details, see [ESP32 Technical Reference Manual](#) > Chapter *Two-wire Automotive Interface (TWAI)*.

### 3.8.13 Ethernet MAC Interface

An IEEE-802.3-2008-compliant Media Access Controller (MAC) is provided for Ethernet LAN communications. ESP32 requires an external physical interface device (PHY) to connect to the physical LAN bus (twisted-pair, fiber, etc.). The PHY is connected to ESP32 through 17 signals of MII or nine signals of RMII. The following features are supported on the Ethernet MAC (EMAC) interface:

- 10 Mbps and 100 Mbps rates
- Dedicated DMA controller allowing high-speed transfer between the dedicated SRAM and Ethernet MAC
- Tagged MAC frame (VLAN support)
- Half-duplex (CSMA/CD) and full-duplex operation
- MAC control sublayer (control frames)
- 32-bit CRC generation and removal
- Several address-filtering modes for physical and multicast address (multicast and group addresses)
- 32-bit status code for each transmitted or received frame
- Internal FIFOs to buffer transmit and receive frames. The transmit FIFO and the receive FIFO are both 512 words (32-bit)
- Hardware PTP (Precision Time Protocol) in accordance with IEEE 1588 2008 (PTP V2)
- 25 MHz/50 MHz clock output

For details, see [ESP32 Technical Reference Manual](#) > Chapter *Ethernet Media Access Controller (MAC)*.

## 3.9 Analog Peripherals

### 3.9.1 Analog-to-Digital Converter (ADC)

ESP32 integrates two 12-bit SAR ADCs and supports measurements on 18 channels (analog-enabled pins). The ULP coprocessor in ESP32 is also designed to measure voltage, while operating in the sleep mode, which

enables low-power consumption. The CPU can be woken up by a threshold setting and/or via other triggers.

With appropriate settings, the ADCs can be configured to measure voltage on 18 pins maximum.

Table 3-3 describes the ADC characteristics.

**Table 3-3. ADC Characteristics**

Parameter	Description	Min	Max	Unit
DNL (Differential nonlinearity)	RTC controller; ADC connected to an external 100 nF capacitor; DC signal input; ambient temperature at 25 °C; Wi-Fi&Bluetooth off	-7	7	LSB
INL (Integral nonlinearity)		-12	12	LSB
Sampling rate	RTC controller	—	200	ksps
	DIG controller	—	2	Msp/s

**Notes:**

- When atten = 3 and the measurement result is above 3000 (voltage at approx. 2450 mV), the ADC accuracy will be worse than described in the table above.
- To get better DNL results, users can take multiple sampling tests with a filter, or calculate the average value.
- The input voltage range of GPIO pins within VDD3P3\_RTC domain should strictly follow the DC characteristics provided in Table 4-3. Otherwise, measurement errors may be introduced, and chip performance may be affected.

By default, there are  $\pm 6\%$  differences in measured results between chips. ESP-IDF provides couple of [calibration methods](#) for ADC1. Results after calibration using eFuse Vref value are shown in Table 3-4. For higher accuracy, users may apply other calibration methods provided in ESP-IDF, or implement their own.

**Table 3-4. ADC Calibration Results**

Parameter	Description	Min	Max	Unit
Total error	Atten = 0, effective measurement range of 100 ~ 950 mV	-23	23	mV
	Atten = 1, effective measurement range of 100 ~ 1250 mV	-30	30	mV
	Atten = 2, effective measurement range of 150 ~ 1750 mV	-40	40	mV
	Atten = 3, effective measurement range of 150 ~ 2450 mV	-60	60	mV

For details, see [ESP32 Technical Reference Manual](#) > Chapter *On-Chip Sensors and Analog Signal Processing*.

### 3.9.2 Digital-to-Analog Converter (DAC)

Two 8-bit DAC channels can be used to convert two digital signals into two analog voltage signal outputs. The design structure is composed of integrated resistor strings and a buffer. This dual DAC supports power supply as input voltage reference. The two DAC channels can also support independent conversions.

For details, see [ESP32 Technical Reference Manual](#) > Chapter *On-Chip Sensors and Analog Signal Processing*.

### 3.9.3 Touch Sensor

ESP32 has 10 capacitive-sensing GPIOs, which detect variations induced by touching or approaching the GPIOs with a finger or other objects. The low-noise nature of the design and the high sensitivity of the circuit allow relatively small pads to be used. Arrays of pads can also be used, so that a larger area or more points can be detected. The 10 capacitive-sensing GPIOs are listed in Table 3-5.

**Table 3-5. Capacitive-Sensing GPIOs Available on ESP32**

Capacitive-Sensing Signal Name	Pin Name
T0	GPIO4
T1	GPIO0
T2	GPIO2
T3	MTDO
T4	MTCK
T5	MTDI
T6	MTMS
T7	GPIO27
T8	32K_XN
T9	32K_XP

For details, see [ESP32 Technical Reference Manual](#) > Chapter *On-Chip Sensors and Analog Signal Processing*.

**Note:**

ESP32 Touch Sensor has not passed the Conducted Susceptibility (CS) test for now, and thus has limited application scenarios.

### 3.10 Peripheral Pin Configurations

Table 3-6. Peripheral Pin Configurations

Interface	Signal	Pin	Function
ADC	ADC1_CH0	SENSOR_VP	Two 12-bit SAR ADCs
	ADC1_CH1	SENSOR_CAPP	
	ADC1_CH2	SENSOR_CAPN	
	ADC1_CH3	SENSOR_VN	
	ADC1_CH4	32K_XP	
	ADC1_CH5	32K_XN	
	ADC1_CH6	VDET_1	
	ADC1_CH7	VDET_2	
	ADC2_CH0	GPIO4	
	ADC2_CH1	GPIO0	
	ADC2_CH2	GPIO2	
	ADC2_CH3	MTDO	
	ADC2_CH4	MTCK	
	ADC2_CH5	MTDI	
	ADC2_CH6	MTMS	
	ADC2_CH7	GPIO27	
	ADC2_CH8	GPIO25	
ADC2_CH9	GPIO26		
DAC	DAC_1	GPIO25	Two 8-bit DACs
	DAC_2	GPIO26	
Touch Sensor	TOUCH0	GPIO4	Capacitive touch sensors
	TOUCH1	GPIO0	
	TOUCH2	GPIO2	
	TOUCH3	MTDO	
	TOUCH4	MTCK	
	TOUCH5	MTDI	
	TOUCH6	MTMS	
	TOUCH7	GPIO27	
	TOUCH8	32K_XN	
	TOUCH9	32K_XP	
JTAG	MTDI	MTDI	JTAG for software debugging
	MTCK	MTCK	
	MTMS	MTMS	
	MTDO	MTDO	

Interface	Signal	Pin	Function
SD/SDIO/MMC Host Controller	HS2_CLK	MTMS	Supports SD memory card V3.01 standard
	HS2_CMD	MTDO	
	HS2_DATA0	GPIO2	
	HS2_DATA1	GPIO4	
	HS2_DATA2	MTDI	
	HS2_DATA3	MTCK	
Motor PWM	PWM0_OUT0~2	Any GPIO Pins	Three channels of 16-bit timers generate PWM waveforms. Each channel has a pair of output signals, three fault detection signals, three event-capture signals, and three sync signals.
	PWM1_OUT_IN0~2		
	PWM0_FLT_IN0~2		
	PWM1_FLT_IN0~2		
	PWM0_CAP_IN0~2		
	PWM1_CAP_IN0~2		
	PWM0_SYNC_IN0~2		
	PWM1_SYNC_IN0~2		
SDIO/SPI Slave Controller	SD_CLK	MTMS	SDIO interface that conforms to the industry standard SDIO 2.0 card specification
	SD_CMD	MTDO	
	SD_DATA0	GPIO2	
	SD_DATA1	GPIO4	
	SD_DATA2	MTDI	
	SD_DATA3	MTCK	
UART	U0RXD_in	Any GPIO Pins	Three UART devices with hardware flow-control and DMA
	U0CTS_in		
	U0DSR_in		
	U0TXD_out		
	U0RTS_out		
	U0DTR_out		
	U1RXD_in		
	U1CTS_in		
	U1TXD_out		
	U1RTS_out		
	U2RXD_in		
	U2CTS_in		
	U2TXD_out		
	U2RTS_out		
I2C	I2CEXT0_SCL_in	Any GPIO Pins	Two I2C devices in slave or master mode
	I2CEXT0_SDA_in		
	I2CEXT1_SCL_in		
	I2CEXT1_SDA_in		
	I2CEXT0_SCL_out		
	I2CEXT0_SDA_out		
	I2CEXT1_SCL_out		
	I2CEXT1_SDA_out		

Interface	Signal	Pin	Function
LED PWM	ledc_hs_sig_out0~7	Any GPIO Pins	16 independent channels @80 MHz clock/RTC CLK. Duty accuracy: 16 bits.
	ledc_ls_sig_out0~7		
I2S	I2S0I_DATA_in0~15	Any GPIO Pins	Stereo input and output from/to the audio codec; parallel LCD data output; parallel camera data input.  <b>Note:</b> I2S0_CLK and I2S1_CLK can only be mapped to GPIO0, UORXD (GPIO3), or UOTXD (GPIO1) via IO MUX by selecting GPIO functions CLK_OUT1, CLK_OUT2, and CLK_OUT3. For more information, see <a href="#">ESP32 Technical Reference Manual</a> > Chapter <i>IO_MUX and GPIO Matrix</i> > Table <i>IO MUX Pad Summary</i> .
	I2S00_BCK_in		
	I2S00_WS_in		
	I2S0I_BCK_in		
	I2S0I_WS_in		
	I2S0I_H_SYNC		
	I2S0I_V_SYNC		
	I2S0I_H_ENABLE		
	I2S00_BCK_out		
	I2S00_WS_out		
	I2S0I_BCK_out		
	I2S0I_WS_out		
	I2S00_DATA_out0~23		
	I2S1I_DATA_in0~15		
	I2S10_BCK_in		
	I2S10_WS_in		
	I2S1I_BCK_in		
	I2S1I_WS_in		
	I2S1I_H_SYNC		
	I2S1I_V_SYNC		
	I2S1I_H_ENABLE		
	I2S10_BCK_out		
	I2S10_WS_out		
I2S1I_BCK_out			
I2S1I_WS_out			
I2S10_DATA_out0~23			
I2S0_CLK	GPIO0, UORXD,		
I2S1_CLK	or UOTXD		
RMT	RMT_SIG_IN0~7	Any GPIO Pins	Eight channels for an IR transmitter and receiver of various waveforms
	RMT_SIG_OUT0~7		
General Purpose SPI	HSPIQ_in/_out	Any GPIO Pins	Standard SPI consists of clock, chip-select, MOSI and MISO. These SPIs can be connected to LCD and other external devices. They support the following features: <ul style="list-style-type: none"> <li>• Both master and slave modes;</li> <li>• Four sub-modes of the SPI transfer format;</li> <li>• Configurable SPI frequency;</li> <li>• Up to 64 bytes of FIFO and DMA.</li> </ul>
	HSPID_in/_out		
	HSPICLK_in/_out		
	HSPI_CS0_in/_out		
	HSPI_CS1_out		
	HSPI_CS2_out		
	VSPIQ_in/_out		
	VSPID_in/_out		
	VSPICLK_in/_out		
	VSPI_CS0_in/_out		
	VSPI_CS1_out		

Interface	Signal	Pin	Function
	VSPi_CS2_out		
Parallel QSPI	SPIHD	SD_DATA_2	Supports Standard SPI, Dual SPI, and Quad SPI that can be connected to the external flash and SRAM
	SPIWP	SD_DATA_3	
	SPICSO	SD_CMD	
	SPICLK	SD_CLK	
	SPIQ	SD_DATA_0	
	SPID	SD_DATA_1	
	HSPICLK	MTMS	
	HSPICSO	MTDO	
	HSPIQ	MTDI	
	HSPID	MTCK	
	HSPIHD	GPIO4	
	HSPIWP	GPIO2	
	VSPICLK	GPIO18	
	VSPICSO	GPIO5	
	VSPIQ	GPIO19	
	VSPID	GPIO23	
	VSPIHD	GPIO21	
VSPIWP	GPIO22		
EMAC	EMAC_TX_CLK	GPIO0	Ethernet MAC with MII/RMII interface
	EMAC_RX_CLK	GPIO5	
	EMAC_TX_EN	GPIO21	
	EMAC_TXD0	GPIO19	
	EMAC_TXD1	GPIO22	
	EMAC_TXD2	MTMS	
	EMAC_TXD3	MTDI	
	EMAC_RX_ER	MTCK	
	EMAC_RX_DV	GPIO27	
	EMAC_RXD0	GPIO25	
	EMAC_RXD1	GPIO26	
	EMAC_RXD2	UOTXD	
	EMAC_RXD3	MTDO	
	EMAC_CLK_OUT	GPIO16	
	EMAC_CLK_OUT_180	GPIO17	
	EMAC_TX_ER	GPIO4	
	EMAC_MDC_out	Any GPIO Pins	
	EMAC_MDI_in	Any GPIO Pins	
	EMAC_MDO_out	Any GPIO Pins	
	EMAC_CRS_out	Any GPIO Pins	
EMAC_COL_out	Any GPIO Pins		

Interface	Signal	Pin	Function
Pulse Counter	pcnt_sig_ch0_in0	Any GPIO Pins	Operating in seven different modes, the pulse counter captures pulse and counts pulse edges.
	pcnt_sig_ch1_in0		
	pcnt_ctrl_ch0_in0		
	pcnt_ctrl_ch1_in0		
	pcnt_sig_ch0_in1		
	pcnt_sig_ch1_in1		
	pcnt_ctrl_ch0_in1		
	pcnt_ctrl_ch1_in1		
	pcnt_sig_ch0_in2		
	pcnt_sig_ch1_in2		
	pcnt_ctrl_ch0_in2		
	pcnt_ctrl_ch1_in2		
	pcnt_sig_ch0_in3		
	pcnt_sig_ch1_in3		
	pcnt_ctrl_ch0_in3		
	pcnt_ctrl_ch1_in3		
	pcnt_sig_ch0_in4		
	pcnt_sig_ch1_in4		
	pcnt_ctrl_ch0_in4		
	pcnt_ctrl_ch1_in4		
	pcnt_sig_ch0_in5		
	pcnt_sig_ch1_in5		
	pcnt_ctrl_ch0_in5		
	pcnt_ctrl_ch1_in5		
	pcnt_sig_ch0_in6		
	pcnt_sig_ch1_in6		
	pcnt_ctrl_ch0_in6		
	pcnt_ctrl_ch1_in6		
pcnt_sig_ch0_in7			
pcnt_sig_ch1_in7			
pcnt_ctrl_ch0_in7			
pcnt_ctrl_ch1_in7			
TWAI	twai_rx	Any GPIO Pins	Compatible with ISO 11898-1 protocol (CAN Specification 2.0)
	twai_tx		
	twai_bus_off_on		
	twai_clkout		

## 4 Electrical Characteristics

### 4.1 Absolute Maximum Ratings

Stresses above those listed in Table 4-1 *Absolute Maximum Ratings* may cause permanent damage to the device. These are stress ratings only and normal operation of the device at these or any other conditions beyond those indicated in Section 4.2 *Recommended Power Supply Characteristics* is not implied. Exposure to absolute-maximum-rated conditions for extended periods may affect device reliability.

Table 4-1. Absolute Maximum Ratings

Parameter	Description	Min	Max	Unit
VDDA, VDD3P3, VDD3P3_RTC, VDD3P3_CPU, VDD_SDIO	Allowed input voltage	-0.3	3.6	V
$I_{output}^1$	Cumulative IO output current	—	1200	mA
$T_{STORE}$	Storage temperature	-40	150	°C

<sup>1</sup> The product proved to be fully functional after all its IO pins were pulled high while being connected to ground for 24 consecutive hours at ambient temperature of 25 °C.

### 4.2 Recommended Power Supply Characteristics

Table 4-2. Recommended Power Supply Characteristics

Parameter	Description	Min	Typ	Max	Unit
VDDA, VDD3P3_RTC <sup>note 1</sup> , VDD3P3, VDD_SDIO (3.3 V mode) <sup>note 2</sup>	Voltage applied to power supply pins per power domain	2.3/3.0 <sup>note 3</sup>	3.3	3.6	V
VDD3P3_CPU	Voltage applied to power supply pin	1.8	3.3	3.6	V
$I_{VDD}$	Current delivered by external power supply	0.5	—	—	A
$T$ <sup>note 4</sup>	Operating temperature	-40	—	125	°C

- When writing eFuse, VDD3P3\_RTC should be at least 3.3 V.
- VDD\_SDIO works as the power supply for the related IO, and also for an external device. Please refer to the Appendix [IO\\_MUX](#) of this datasheet for more details.
  - VDD\_SDIO can be sourced internally by the ESP32 from the VDD3P3\_RTC power domain:
    - When VDD\_SDIO operates at 3.3 V, it is driven directly by VDD3P3\_RTC through a 6 Ω resistor, therefore, there will be some voltage drop from VDD3P3\_RTC.
    - When VDD\_SDIO operates at 1.8 V, it can be generated from ESP32's internal LDO. The maximum current this LDO can offer is 40 mA, and the output voltage range is 1.65 V ~ 2.0 V.
  - VDD\_SDIO can also be driven by an external power supply.
  - Please refer to Section 2.3.1 [Power Scheme](#), for more information.
- Chips with a 3.3 V flash or PSRAM in-package: this minimum voltage is 3.0 V;
  - Chips with no flash or PSRAM in-package: this minimum voltage is 2.3 V;
  - For more information, see Section 1 [ESP32 Series Comparison](#).
- The operating temperature of ESP32-U4WDH ranges from -40 °C to 105 °C, due to the in-package flash.
  - The operating temperature of ESP32-D0WDR2-V3 ranges from -40 °C to 85 °C, due to the in-package PSRAM.
  - For other chips that have no in-package flash or PSRAM, their operating temperature is -40 °C ~ 125 °C.

### 4.3 DC Characteristics (3.3 V, 25 °C)

Table 4-3. DC Characteristics (3.3 V, 25 °C)

Parameter	Description	Min	Typ	Max	Unit	
$C_{IN}$	Pin capacitance	—	2	—	pF	
$V_{IH}$	High-level input voltage	$0.75 \times VDD^1$	—	$VDD^1 + 0.3$	V	
$V_{IL}$	Low-level input voltage	-0.3	—	$0.25 \times VDD^1$	V	
$I_{IH}$	High-level input current	—	—	50	nA	
$I_{IL}$	Low-level input current	—	—	50	nA	
$V_{OH}$	High-level output voltage	$0.8 \times VDD^1$	—	—	V	
$V_{OL}$	Low-level output voltage	—	—	$0.1 \times VDD^1$	V	
$I_{OH}$	High-level source current ( $VDD^1 = 3.3$ V, $V_{OH} \geq 2.64$ V, output drive strength set to the maximum)	VDD3P3_CPU power domain <sup>1, 2</sup>	—	40	—	mA
		VDD3P3_RTC power domain <sup>1, 2</sup>	—	40	—	mA
		VDD_SDIO power domain <sup>1, 3</sup>	—	20	—	mA
$I_{OL}$	Low-level sink current ( $VDD^1 = 3.3$ V, $V_{OL} = 0.495$ V, output drive strength set to the maximum)	—	28	—	mA	
$R_{PU}$	Resistance of internal pull-up resistor	—	45	—	k $\Omega$	
$R_{PD}$	Resistance of internal pull-down resistor	—	45	—	k $\Omega$	
$V_{IL\_nRST}$	Low-level input voltage of CHIP_PU to shut down the chip	—	—	0.6	V	

1. Please see Table IO\_MUX for IO's power domain. VDD is the I/O voltage for a particular power domain of pins.
2. For VDD3P3\_CPU and VDD3P3\_RTC power domain, per-pin current sourced in the same domain is gradually reduced from around 40 mA to around 29 mA,  $V_{OH} \geq 2.64$  V, as the number of current-source pins increases.
3. For VDD\_SDIO power domain, per-pin current sourced in the same domain is gradually reduced from around 30 mA to around 10 mA,  $V_{OH} \geq 2.64$  V, as the number of current-source pins increases.

### 4.4 RF Current Consumption in Active Mode

The current consumption measurements are taken with a 3.3 V supply at 25 °C of ambient temperature at the RF port. All transmitters' measurements are based on a 50% duty cycle.

Table 4-4. Current Consumption Depending on RF Modes

Work Mode	Min	Typ	Max	Unit
Transmit 802.11b, DSSS 1 Mbps, POUT = +19.5 dBm	—	240	—	mA
Transmit 802.11g, OFDM 54 Mbps, POUT = +16 dBm	—	190	—	mA
Transmit 802.11n, OFDM MCS7, POUT = +14 dBm	—	180	—	mA
Receive 802.11b/g/n	—	95 ~ 100	—	mA
Transmit BT/BLE, POUT = 0 dBm	—	130	—	mA
Receive BT/BLE	—	95 ~ 100	—	mA

## 4.5 Reliability

Table 4-5. Reliability Qualifications

Test Item	Test Conditions	Test Standard
HTOL (High Temperature Operating Life)	125 °C, 1000 hours	JESD22-A108
ESD (Electro-Static Discharge Sensitivity)	HBM (Human Body Mode) <sup>1</sup> ± 2000 V	JS-001
	CDM (Charge Device Mode) <sup>2</sup> ± 500 V	JS-002
Latch up	Current trigger ± 200 mA	JESD78
	Voltage trigger $1.5 \times VDD_{max}$	
Preconditioning	Bake 24 hours @125 °C Moisture soak (level 3: 192 hours @30 °C, 60% RH) IR reflow solder: 260 + 0 °C, 20 seconds, three times	J-STD-020, JESD47, JESD22-A113
TCT (Temperature Cycling Test)	-65 °C / 150 °C, 500 cycles	JESD22-A104
Autoclave Test	121 °C, 100% RH, 96 hours	JESD22-A102
uHAST (Highly Accelerated Stress Test, unbiased)	130 °C, 85% RH, 96 hours	JESD22-A118
HTSL (High Temperature Storage Life)	150 °C, 1000 hours	JESD22-A103

1. JEDEC document JEP155 states that 500 V HBM allows safe manufacturing with a standard ESD control process.
2. JEDEC document JEP157 states that 250 V CDM allows safe manufacturing with a standard ESD control process.

## 4.6 Wi-Fi Radio

Table 4-6. Wi-Fi Radio Characteristics

Parameter	Description	Min	Typ	Max	Unit
Operating frequency range <sup>note1</sup>	—	2412	—	2484	MHz
Output impedance <sup>note2</sup>	-	-	<i>note 2</i>	—	Ω
TX power <sup>note3</sup>	11n, MCS7	12	13	14	dBm
	11b mode	18.5	19.5	20.5	dBm
Sensitivity	11b, 1 Mbps	—	-98	—	dBm
	11b, 11 Mbps	—	-88	—	dBm
	11g, 6 Mbps	—	-93	—	dBm
	11g, 54 Mbps	—	-75	—	dBm
	11n, HT20, MCS0	—	-93	—	dBm
	11n, HT20, MCS7	—	-73	—	dBm
	11n, HT40, MCS0	—	-90	—	dBm
	11n, HT40, MCS7	—	-70	—	dBm
	11g, 6 Mbps	—	27	—	dB

Adjacent channel rejection

Parameter	Description	Min	Typ	Max	Unit
	11g, 54 Mbps	—	13	—	dB
	11n, HT20, MCS0	—	27	—	dB
	11n, HT20, MCS7	—	12	—	dB

1. Device should operate in the frequency range allocated by regional regulatory authorities. Target operating frequency range is configurable by software.
2. The typical value of the Wi-Fi radio output impedance is different between chips in different QFN packages. For chips in a QFN 6×6 package, the value is 30+j10 Ω. For chips in a QFN 5×5 package, the value is 35+j10 Ω.
3. Target TX power is configurable based on device or certification requirements.

## 4.7 Bluetooth Radio

### 4.7.1 Receiver –Basic Data Rate

Table 4-7. Receiver Characteristics –Basic Data Rate

Parameter	Description	Min	Typ	Max	Unit
Sensitivity @0.1% BER	—	–90	–89	–88	dBm
Maximum received signal @0.1% BER	—	0	—	—	dBm
Co-channel C/I	—	—	+7	—	dB
Adjacent channel selectivity C/I	F = FO + 1 MHz	—	—	–6	dB
	F = FO –1 MHz	—	—	–6	dB
	F = FO + 2 MHz	—	—	–25	dB
	F = FO –2 MHz	—	—	–33	dB
	F = FO + 3 MHz	—	—	–25	dB
	F = FO –3 MHz	—	—	–45	dB
Out-of-band blocking performance	30 MHz ~ 2000 MHz	–10	—	—	dBm
	2000 MHz ~ 2400 MHz	–27	—	—	dBm
	2500 MHz ~ 3000 MHz	–27	—	—	dBm
	3000 MHz ~ 12.5 GHz	–10	—	—	dBm
Intermodulation	—	–36	—	—	dBm

### 4.7.2 Transmitter –Basic Data Rate

Table 4-8. Transmitter Characteristics –Basic Data Rate

Parameter	Description	Min	Typ	Max	Unit
RF transmit power <i>note1</i>	—	—	0	—	dBm
Gain control step	—	—	3	—	dB
RF power control range	—	–12	—	+9	dBm
+20 dB bandwidth	—	—	0.9	—	MHz
Adjacent channel transmit power	F = FO ± 2 MHz	—	–47	—	dBm
	F = FO ± 3 MHz	—	–55	—	dBm
	F = FO ± > 3 MHz	—	–60	—	dBm

Parameter	Description	Min	Typ	Max	Unit
$\Delta f_{1\text{avg}}$	—	—	—	155	kHz
$\Delta f_{2\text{max}}$	—	133.7	—	—	kHz
$\Delta f_{2\text{avg}}/\Delta f_{1\text{avg}}$	—	—	0.92	—	—
ICFT	—	—	-7	—	kHz
Drift rate	—	—	0.7	—	kHz/50 $\mu$ s
Drift (DH1)	—	—	6	—	kHz
Drift (DH5)	—	—	6	—	kHz

- There are in total eight power levels from level 0 to level 7, with transmit power ranging from -12 dBm to 9 dBm. When the power level rises by 1, the transmit power increases by 3 dB. Power level 4 is used by default and the corresponding transmit power is 0 dBm.

### 4.7.3 Receiver –Enhanced Data Rate

Table 4-9. Receiver Characteristics –Enhanced Data Rate

Parameter	Description	Min	Typ	Max	Unit
$\pi/4$ DQPSK					
Sensitivity @0.01% BER	—	-90	-89	-88	dBm
Maximum received signal @0.01% BER	—	—	0	—	dBm
Co-channel C/I	—	—	11	—	dB
Adjacent channel selectivity C/I	F = FO + 1 MHz	—	-7	—	dB
	F = FO -1 MHz	—	-7	—	dB
	F = FO + 2 MHz	—	-25	—	dB
	F = FO -2 MHz	—	-35	—	dB
	F = FO + 3 MHz	—	-25	—	dB
	F = FO -3 MHz	—	-45	—	dB
8DPSK					
Sensitivity @0.01% BER	—	-84	-83	-82	dBm
Maximum received signal @0.01% BER	—	—	-5	—	dBm
C/I c-channel	—	—	18	—	dB
Adjacent channel selectivity C/I	F = FO + 1 MHz	—	2	—	dB
	F = FO -1 MHz	—	2	—	dB
	F = FO + 2 MHz	—	-25	—	dB
	F = FO -2 MHz	—	-25	—	dB
	F = FO + 3 MHz	—	-25	—	dB
	F = FO -3 MHz	—	-38	—	dB

### 4.7.4 Transmitter –Enhanced Data Rate

Table 4-10. Transmitter Characteristics –Enhanced Data Rate

Parameter	Description	Min	Typ	Max	Unit
RF transmit power (see note under Table 4-10)	—	—	0	—	dBm

Parameter	Description	Min	Typ	Max	Unit
Gain control step	—	—	3	—	dB
RF power control range	—	-12	—	+9	dBm
$\pi/4$ DQPSK max w0	—	—	-0.72	—	kHz
$\pi/4$ DQPSK max wi	—	—	-6	—	kHz
$\pi/4$ DQPSK max  wi + w0	—	—	-7.42	—	kHz
8DPSK max w0	—	—	0.7	—	kHz
8DPSK max wi	—	—	-9.6	—	kHz
8DPSK max  wi + w0	—	—	-10	—	kHz
$\pi/4$ DQPSK modulation accuracy	RMS DEVM	—	4.28	—	%
	99% DEVM	—	100	—	%
	Peak DEVM	—	13.3	—	%
8 DPSK modulation accuracy	RMS DEVM	—	5.8	—	%
	99% DEVM	—	100	—	%
	Peak DEVM	—	14	—	%
In-band spurious emissions	F = FO $\pm$ 1 MHz	—	-46	—	dBm
	F = FO $\pm$ 2 MHz	—	-40	—	dBm
	F = FO $\pm$ 3 MHz	—	-46	—	dBm
	F = FO +/-> 3 MHz	—	—	-53	dBm
EDR differential phase coding	—	—	100	—	%

## 4.8 Bluetooth LE Radio

### 4.8.1 Receiver

Table 4-11. Receiver Characteristics –Bluetooth LE

Parameter	Description	Min	Typ	Max	Unit
Sensitivity @30.8% PER	—	-94	-93	-92	dBm
Maximum received signal @30.8% PER	—	0	—	—	dBm
Co-channel C/I	—	—	+10	—	dB
Adjacent channel selectivity C/I	F = FO + 1 MHz	—	-5	—	dB
	F = FO -1 MHz	—	-5	—	dB
	F = FO + 2 MHz	—	-25	—	dB
	F = FO -2 MHz	—	-35	—	dB
	F = FO + 3 MHz	—	-25	—	dB
	F = FO -3 MHz	—	-45	—	dB
Out-of-band blocking performance	30 MHz ~ 2000 MHz	-10	—	—	dBm
	2000 MHz ~ 2400 MHz	-27	—	—	dBm
	2500 MHz ~ 3000 MHz	-27	—	—	dBm
	3000 MHz ~ 12.5 GHz	-10	—	—	dBm
Intermodulation	—	-36	—	—	dBm

## 4.8.2 Transmitter

Table 4-12. Transmitter Characteristics –Bluetooth LE

Parameter	Description	Min	Typ	Max	Unit
RF transmit power (see note under Table 4-8)	—	—	0	—	dBm
Gain control step	—	—	3	—	dB
RF power control range	—	-12	—	+9	dBm
Adjacent channel transmit power	F = FO ± 2 MHz	—	-52	—	dBm
	F = FO ± 3 MHz	—	-58	—	dBm
	F = FO ± > 3 MHz	—	-60	—	dBm
$\Delta f_{1_{avg}}$	—	—	—	265	kHz
$\Delta f_{2_{max}}$	—	247	—	—	kHz
$\Delta f_{2_{avg}}/\Delta f_{1_{avg}}$	—	—	0.92	—	—
ICFT	—	—	-10	—	kHz
Drift rate	—	—	0.7	—	kHz/50 $\mu$ s
Drift	—	—	2	—	kHz

## 5 Packaging

- For information about tape, reel, and chip marking, please refer to [Espressif Chip Packaging Information](#).
- The pins of the chip are numbered in anti-clockwise order starting from Pin 1 in the top view. For pin numbers and pin names, see also pin layout figures in Section 2.1 Pin Layout.

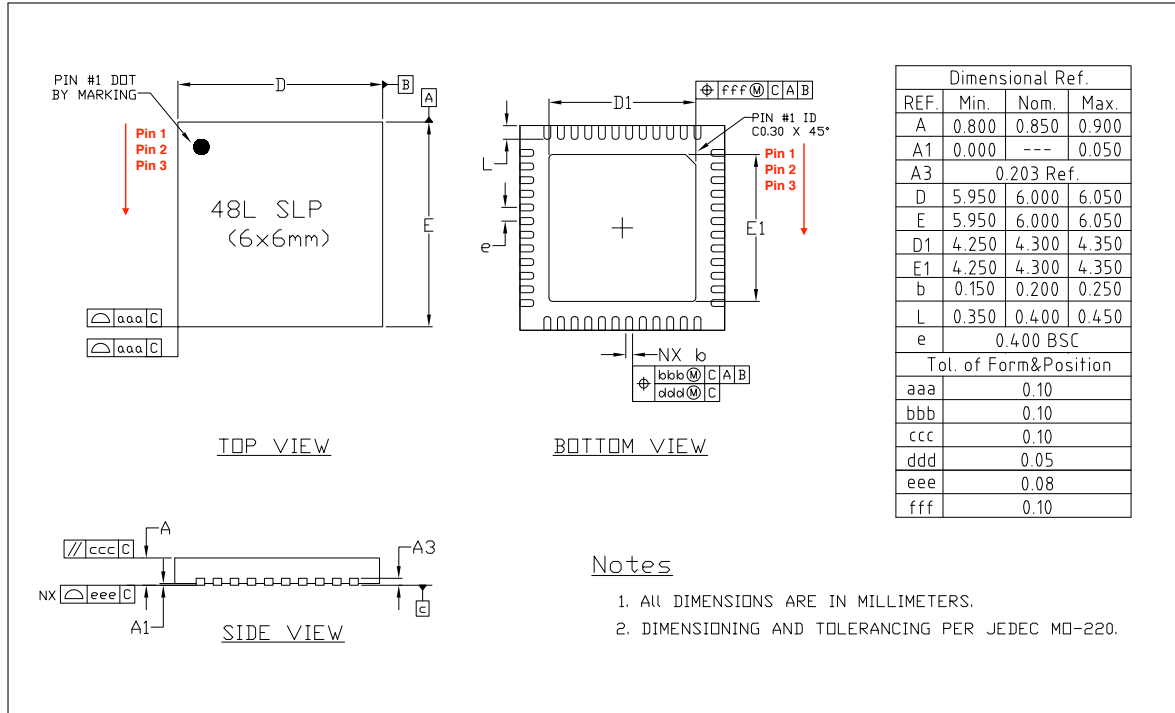

Figure 5-1. QFN48 (6x6 mm) Package

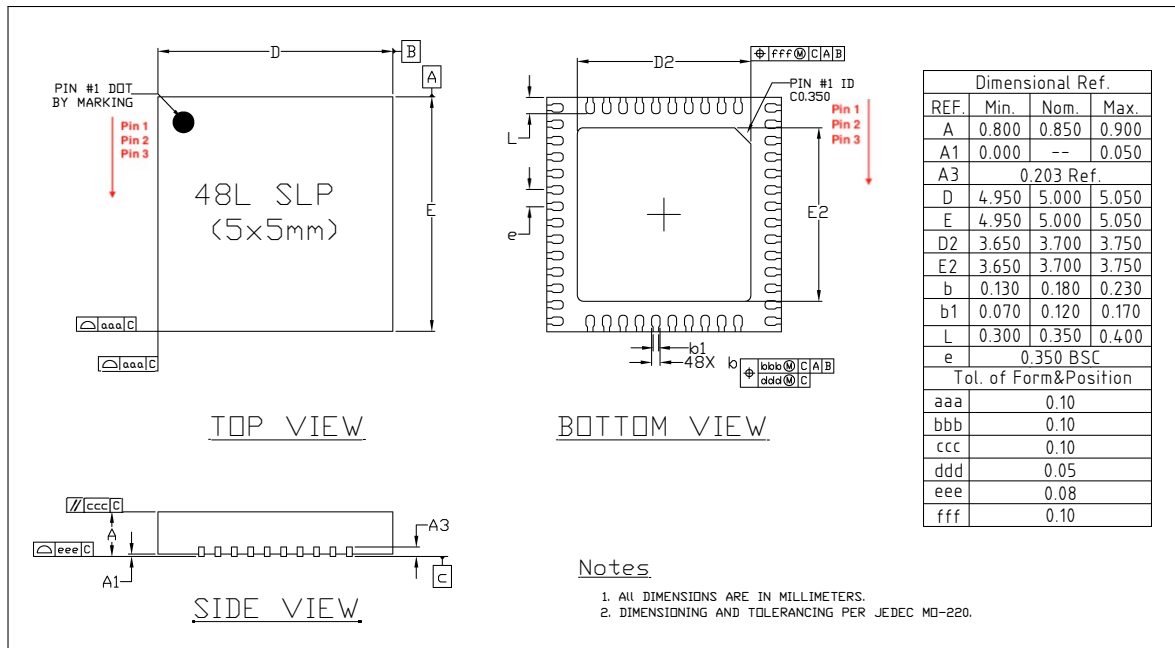

Figure 5-2. QFN48 (5x5 mm) Package

## Related Documentation and Resources

### Related Documentation

- [ESP32 Technical Reference Manual](#) – Detailed information on how to use the ESP32 memory and peripherals.
- [ESP32 Hardware Design Guidelines](#) – Guidelines on how to integrate the ESP32 into your hardware product.
- [ESP32 ECO and Workarounds for Bugs](#) – Correction of ESP32 design errors.
- *Certificates*  
<https://espressif.com/en/support/documents/certificates>
- *ESP32 Product/Process Change Notifications (PCN)*  
<https://espressif.com/en/support/documents/pcns>
- *ESP32 Advisories* – Information on security, bugs, compatibility, component reliability.  
<https://espressif.com/en/support/documents/advisories>
- *Documentation Updates and Update Notification Subscription*  
<https://espressif.com/en/support/download/documents>

### Developer Zone

- [ESP-IDF Programming Guide for ESP32](#) – Extensive documentation for the ESP-IDF development framework.
- *ESP-IDF* and other development frameworks on GitHub.  
<https://github.com/espressif>
- *ESP32 BBS Forum* – Engineer-to-Engineer (E2E) Community for Espressif products where you can post questions, share knowledge, explore ideas, and help solve problems with fellow engineers.  
<https://esp32.com/>
- *The ESP Journal* – Best Practices, Articles, and Notes from Espressif folks.  
<https://blog.espressif.com/>
- See the tabs *SDKs and Demos, Apps, Tools, AT Firmware*.  
<https://espressif.com/en/support/download/sdks-demos>

### Products

- *ESP32 Series SoCs* – Browse through all ESP32 SoCs.  
<https://espressif.com/en/products/socs?id=ESP32>
- *ESP32 Series Modules* – Browse through all ESP32-based modules.  
<https://espressif.com/en/products/modules?id=ESP32>
- *ESP32 Series DevKits* – Browse through all ESP32-based devkits.  
<https://espressif.com/en/products/devkits?id=ESP32>
- *ESP Product Selector* – Find an Espressif hardware product suitable for your needs by comparing or applying filters.  
<https://products.espressif.com/#/product-selector?language=en>

### Contact Us

- See the tabs *Sales Questions, Technical Enquiries, Circuit Schematic & PCB Design Review, Get Samples* (Online stores), *Become Our Supplier, Comments & Suggestions*.  
<https://espressif.com/en/contact-us/sales-questions>

## Appendix A –ESP32 Pin Lists

### A.1. Notes on ESP32 Pin Lists

Table 5-1. Notes on ESP32 Pin Lists

No.	Description
1	In Table <a href="#">IO_MUX</a> , the boxes highlighted in yellow indicate the GPIO pins that are input-only. Please see the following note for further details.
2	GPIO pins 34-39 are input-only. These pins do not feature an output driver or internal pull-up/pull-down circuitry. The pin names are: SENSOR_VP (GPIO36), SENSOR_CAPP (GPIO37), SENSOR_CAPN (GPIO38), SENSOR_VN (GPIO39), VDET_1 (GPIO34), VDET_2 (GPIO35).
3	The pins are grouped into four power domains: VDDA (analog power supply), VDD3P3_RTC (RTC power supply), VDD3P3_CPU (power supply of digital IOs and CPU cores), VDD_SDIO (power supply of SDIO IOs). VDD_SDIO is the output of the internal SDIO-LDO. The voltage of SDIO-LDO can be configured at 1.8 V or be the same as that of VDD3P3_RTC. The strapping pin and eFuse bits determine the default voltage of the SDIO-LDO. Software can change the voltage of the SDIO-LDO by configuring register bits. For details, please see the column “Power Domain” in Table <a href="#">IO_MUX</a> .
4	The functional pins in the VDD3P3_RTC domain are those with analog functions, including the 32 kHz crystal oscillator, ADC, DAC, and the capacitive touch sensor. Please see columns “Analog Function 0 ~ 2” in Table <a href="#">IO_MUX</a> .
5	These VDD3P3_RTC pins support the RTC function, and can work during Deep-sleep. For example, an RTC-GPIO can be used for waking up the chip from Deep-sleep.
6	The GPIO pins support up to six digital functions, as shown in columns “Function 0 ~ 5” in Table <a href="#">IO_MUX</a> . The function selection registers will be set as “N”, where N is the function number. Below are some definitions: <ul style="list-style-type: none"> <li>• SD_* is for signals of the SDIO slave.</li> <li>• HS1_* is for Port 1 signals of the SDIO host.</li> <li>• HS2_* is for Port 2 signals of the SDIO host.</li> <li>• MT* is for signals of the JTAG.</li> <li>• U0* is for signals of the UART0 module.</li> <li>• U1* is for signals of the UART1 module.</li> <li>• U2* is for signals of the UART2 module.</li> <li>• SPI* is for signals of the SPI01 module.</li> <li>• HSPI* is for signals of the SPI2 module.</li> <li>• VSPI* is for signals of the SPI3 module.</li> </ul>

No.	Description
7	<p>Each column about digital “Function” is accompanied by a column about “Type”. Please see the following explanations for the meanings of “type” with respect to each “function” they are associated with. For each “Function-<i>N</i>”, “type” signifies:</p> <ul style="list-style-type: none"> <li>● I: input only. If a function other than “Function-<i>N</i>” is assigned, the input signal of “Function-<i>N</i>” is still from this pin.</li> <li>● I1: input only. If a function other than “Function-<i>N</i>” is assigned, the input signal of “Function-<i>N</i>” is always “1”.</li> <li>● IO: input only. If a function other than “Function-<i>N</i>” is assigned, the input signal of “Function-<i>N</i>” is always “0”.</li> <li>● O: output only.</li> <li>● T: high-impedance.</li> <li>● I/O/T: combinations of input, output, and high-impedance according to the function signal.</li> <li>● I1/O/T: combinations of input, output, and high-impedance, according to the function signal. If a function is not selected, the input signal of the function is “1”.</li> </ul> <p>For example, pin 30 can function as HS1_CMD or SD_CMD, where HS1_CMD is of an “I1/O/T” type. If pin 30 is selected as HS1_CMD, this pin’s input and output are controlled by the SDIO host. If pin 30 is not selected as HS1_CMD, the input signal of the SDIO host is always “1”.</p>
8	<p>Each digital output pin is associated with its configurable drive strength. Column “Drive Strength” in Table <a href="#">IO_MUX</a> lists the default values. The drive strength of the digital output pins can be configured into one of the following four options:</p> <ul style="list-style-type: none"> <li>● 0: ~5 mA</li> <li>● 1: ~10 mA</li> <li>● 2: ~20 mA</li> <li>● 3: ~40 mA</li> </ul> <p>The default value is 2. The drive strength of the internal pull-up (wpu) and pull-down (wpd) is ~75 <math>\mu</math>A.</p>
9	<p>Column “At Reset” in Table <a href="#">IO_MUX</a> lists the status of each pin during reset, including input-enable (ie=1), internal pull-up (wpu) and internal pull-down (wpd). During reset, all pins are output-disabled.</p>
10	<p>Column “After Reset” in Table <a href="#">IO_MUX</a> lists the status of each pin immediately after reset, including input-enable (ie=1), internal pull-up (wpu) and internal pull-down (wpd). After reset, each pin is set to “Function 0”. The output-enable is controlled by digital Function 0.</p>
11	<p>Table <a href="#">Ethernet_MAC</a> is about the signal mapping inside Ethernet MAC. The Ethernet MAC supports MII and RMII interfaces, and supports both the internal PLL clock and the external clock source. For the MII interface, the Ethernet MAC is with/without the TX_ERR signal. MDC, MDIO, CRS and COL are slow signals, and can be mapped onto any GPIO pin through the GPIO-Matrix.</p>
12	<p>Table <a href="#">GPIO Matrix</a> is for the GPIO-Matrix. The signals of the on-chip functional modules can be mapped onto any GPIO pin. Some signals can be mapped onto a pin by both IO-MUX and GPIO-Matrix, as shown in the column tagged as “Same input signal from IO_MUX core” in Table <a href="#">GPIO Matrix</a>.</p>

No.	Description
13	*In Table <a href="#">GPIO_Matrix</a> , the column “Default Value if unassigned” records the default value of the an input signal if no GPIO is assigned to it. The actual value is determined by register GPIO_FUNC <i>m</i> _IN_INV_SEL and GPIO_FUNC <i>m</i> _IN_SEL. (The value of <i>m</i> ranges from 1 to 255.)

## A.2. GPIO\_Matrix

Table 5-2. GPIO\_Matrix

Signal No.	Input Signals	Default Value If Unassigned*	Same Input Signal from IO_MUX Core	Output Signals	Output Enable of Output Signals
0	SPICLK_in	0	yes	SPICLK_out	SPICLK_oe
1	SPIQ_in	0	yes	SPIQ_out	SPIQ_oe
2	SPID_in	0	yes	SPID_out	SPID_oe
3	SPIHD_in	0	yes	SPIHD_out	SPIHD_oe
4	SPIWP_in	0	yes	SPIWP_out	SPIWP_oe
5	SPICSO_in	0	yes	SPICSO_out	SPICSO_oe
6	SPICS1_in	0	no	SPICS1_out	SPICS1_oe
7	SPICS2_in	0	no	SPICS2_out	SPICS2_oe
8	HSPICLK_in	0	yes	HSPICLK_out	HSPICLK_oe
9	HSPIQ_in	0	yes	HSPIQ_out	HSPIQ_oe
10	HSPID_in	0	yes	HSPID_out	HSPID_oe
11	HSPICSO_in	0	yes	HSPICSO_out	HSPICSO_oe
12	HSPIHD_in	0	yes	HSPIHD_out	HSPIHD_oe
13	HSPIWP_in	0	yes	HSPIWP_out	HSPIWP_oe
14	UORXD_in	0	yes	UOTXD_out	1'd1
15	UOCTS_in	0	yes	UORTS_out	1'd1
16	UODSR_in	0	no	UODTR_out	1'd1
17	U1RXD_in	0	yes	U1TXD_out	1'd1
18	U1CTS_in	0	yes	U1RTS_out	1'd1
23	I2S00_BCK_in	0	no	I2S00_BCK_out	1'd1
24	I2S10_BCK_in	0	no	I2S10_BCK_out	1'd1
25	I2S00_WS_in	0	no	I2S00_WS_out	1'd1
26	I2S10_WS_in	0	no	I2S10_WS_out	1'd1
27	I2S0I_BCK_in	0	no	I2S0I_BCK_out	1'd1
28	I2S0I_WS_in	0	no	I2S0I_WS_out	1'd1
29	I2CEXT0_SCL_in	1	no	I2CEXT0_SCL_out	1'd1
30	I2CEXT0_SDA_in	1	no	I2CEXT0_SDA_out	1'd1
31	pwm0_sync0_in	0	no	sdio_tohost_int_out	1'd1
32	pwm0_sync1_in	0	no	pwm0_out0a	1'd1
33	pwm0_sync2_in	0	no	pwm0_out0b	1'd1
34	pwm0_f0_in	0	no	pwm0_out1a	1'd1

Signal No.	Input Signals	Default Value If Unassigned*	Same Input Signal from IO_MUX Core	Output Signals	Output Enable of Output Signals
35	pwm0_f1_in	0	no	pwm0_out1b	1'd1
36	pwm0_f2_in	0	no	pwm0_out2a	1'd1
37	—	0	no	pwm0_out2b	1'd1
39	pcnt_sig_ch0_in0	0	no	—	1'd1
40	pcnt_sig_ch1_in0	0	no	—	1'd1
41	pcnt_ctrl_ch0_in0	0	no	—	1'd1
42	pcnt_ctrl_ch1_in0	0	no	—	1'd1
43	pcnt_sig_ch0_in1	0	no	—	1'd1
44	pcnt_sig_ch1_in1	0	no	—	1'd1
45	pcnt_ctrl_ch0_in1	0	no	—	1'd1
46	pcnt_ctrl_ch1_in1	0	no	—	1'd1
47	pcnt_sig_ch0_in2	0	no	—	1'd1
48	pcnt_sig_ch1_in2	0	no	—	1'd1
49	pcnt_ctrl_ch0_in2	0	no	—	1'd1
50	pcnt_ctrl_ch1_in2	0	no	—	1'd1
51	pcnt_sig_ch0_in3	0	no	—	1'd1
52	pcnt_sig_ch1_in3	0	no	—	1'd1
53	pcnt_ctrl_ch0_in3	0	no	—	1'd1
54	pcnt_ctrl_ch1_in3	0	no	—	1'd1
55	pcnt_sig_ch0_in4	0	no	—	1'd1
56	pcnt_sig_ch1_in4	0	no	—	1'd1
57	pcnt_ctrl_ch0_in4	0	no	—	1'd1
58	pcnt_ctrl_ch1_in4	0	no	—	1'd1
61	HSPICS1_in	0	no	HSPICS1_out	HSPICS1_oe
62	HSPICS2_in	0	no	HSPICS2_out	HSPICS2_oe
63	VSPICLK_in	0	yes	VSPICLK_out_mux	VSPICLK_oe
64	VSPIQ_in	0	yes	VSPIQ_out	VSPIQ_oe
65	VSPID_in	0	yes	VSPID_out	VSPID_oe
66	VSPiHD_in	0	yes	VSPiHD_out	VSPiHD_oe
67	VSPiWP_in	0	yes	VSPiWP_out	VSPiWP_oe
68	VSPiCS0_in	0	yes	VSPiCS0_out	VSPiCS0_oe
69	VSPiCS1_in	0	no	VSPiCS1_out	VSPiCS1_oe
70	VSPiCS2_in	0	no	VSPiCS2_out	VSPiCS2_oe
71	pcnt_sig_ch0_in5	0	no	ledc_hs_sig_out0	1'd1
72	pcnt_sig_ch1_in5	0	no	ledc_hs_sig_out1	1'd1
73	pcnt_ctrl_ch0_in5	0	no	ledc_hs_sig_out2	1'd1
74	pcnt_ctrl_ch1_in5	0	no	ledc_hs_sig_out3	1'd1
75	pcnt_sig_ch0_in6	0	no	ledc_hs_sig_out4	1'd1
76	pcnt_sig_ch1_in6	0	no	ledc_hs_sig_out5	1'd1
77	pcnt_ctrl_ch0_in6	0	no	ledc_hs_sig_out6	1'd1
78	pcnt_ctrl_ch1_in6	0	no	ledc_hs_sig_out7	1'd1

Signal No.	Input Signals	Default Value If Unassigned*	Same Input Signal from IO_MUX Core	Output Signals	Output Enable of Output Signals
79	pcnt_sig_ch0_in7	0	no	ledc_ls_sig_out0	1'd1
80	pcnt_sig_ch1_in7	0	no	ledc_ls_sig_out1	1'd1
81	pcnt_ctrl_ch0_in7	0	no	ledc_ls_sig_out2	1'd1
82	pcnt_ctrl_ch1_in7	0	no	ledc_ls_sig_out3	1'd1
83	rmt_sig_in0	0	no	ledc_ls_sig_out4	1'd1
84	rmt_sig_in1	0	no	ledc_ls_sig_out5	1'd1
85	rmt_sig_in2	0	no	ledc_ls_sig_out6	1'd1
86	rmt_sig_in3	0	no	ledc_ls_sig_out7	1'd1
87	rmt_sig_in4	0	no	rmt_sig_out0	1'd1
88	rmt_sig_in5	0	no	rmt_sig_out1	1'd1
89	rmt_sig_in6	0	no	rmt_sig_out2	1'd1
90	rmt_sig_in7	0	no	rmt_sig_out3	1'd1
91	—	—	—	rmt_sig_out4	1'd1
92	—	—	—	rmt_sig_out6	1'd1
94	twai_rx	1	no	rmt_sig_out7	1'd1
95	I2CEXT1_SCL_in	1	no	I2CEXT1_SCL_out	1'd1
96	I2CEXT1_SDA_in	1	no	I2CEXT1_SDA_out	1'd1
97	host_card_detect_n_1	0	no	host_ccmd_od_pullup_en_n	1'd1
98	host_card_detect_n_2	0	no	host_rst_n_1	1'd1
99	host_card_write_prt_1	0	no	host_rst_n_2	1'd1
100	host_card_write_prt_2	0	no	gpio_sd0_out	1'd1
101	host_card_int_n_1	0	no	gpio_sd1_out	1'd1
102	host_card_int_n_2	0	no	gpio_sd2_out	1'd1
103	pwm1_sync0_in	0	no	gpio_sd3_out	1'd1
104	pwm1_sync1_in	0	no	gpio_sd4_out	1'd1
105	pwm1_sync2_in	0	no	gpio_sd5_out	1'd1
106	pwm1_f0_in	0	no	gpio_sd6_out	1'd1
107	pwm1_f1_in	0	no	gpio_sd7_out	1'd1
108	pwm1_f2_in	0	no	pwm1_out0a	1'd1
109	pwm0_cap0_in	0	no	pwm1_out0b	1'd1
110	pwm0_cap1_in	0	no	pwm1_out1a	1'd1
111	pwm0_cap2_in	0	no	pwm1_out1b	1'd1
112	pwm1_cap0_in	0	no	pwm1_out2a	1'd1
113	pwm1_cap1_in	0	no	pwm1_out2b	1'd1
114	pwm1_cap2_in	0	no	pwm2_out1h	1'd1
115	pwm2_fta	1	no	pwm2_out1l	1'd1
116	pwm2_ftb	1	no	pwm2_out2h	1'd1
117	pwm2_cap1_in	0	no	pwm2_out2l	1'd1
118	pwm2_cap2_in	0	no	pwm2_out3h	1'd1
119	pwm2_cap3_in	0	no	pwm2_out3l	1'd1
120	pwm3_fta	1	no	pwm2_out4h	1'd1

Signal No.	Input Signals	Default Value If Unassigned*	Same Input Signal from IO_MUX Core	Output Signals	Output Enable of Output Signals
121	pwm3_ftb	1	no	pwm2_out4l	1'd1
122	pwm3_cap1_in	0	no	—	1'd1
123	pwm3_cap2_in	0	no	twai_tx	1'd1
124	pwm3_cap3_in	0	no	twai_bus_off_on	1'd1
125	—	—	—	twai_clkout	1'd1
140	I2SOI_DATA_in0	0	no	I2S00_DATA_out0	1'd1
141	I2SOI_DATA_in1	0	no	I2S00_DATA_out1	1'd1
142	I2SOI_DATA_in2	0	no	I2S00_DATA_out2	1'd1
143	I2SOI_DATA_in3	0	no	I2S00_DATA_out3	1'd1
144	I2SOI_DATA_in4	0	no	I2S00_DATA_out4	1'd1
145	I2SOI_DATA_in5	0	no	I2S00_DATA_out5	1'd1
146	I2SOI_DATA_in6	0	no	I2S00_DATA_out6	1'd1
147	I2SOI_DATA_in7	0	no	I2S00_DATA_out7	1'd1
148	I2SOI_DATA_in8	0	no	I2S00_DATA_out8	1'd1
149	I2SOI_DATA_in9	0	no	I2S00_DATA_out9	1'd1
150	I2SOI_DATA_in10	0	no	I2S00_DATA_out10	1'd1
151	I2SOI_DATA_in11	0	no	I2S00_DATA_out11	1'd1
152	I2SOI_DATA_in12	0	no	I2S00_DATA_out12	1'd1
153	I2SOI_DATA_in13	0	no	I2S00_DATA_out13	1'd1
154	I2SOI_DATA_in14	0	no	I2S00_DATA_out14	1'd1
155	I2SOI_DATA_in15	0	no	I2S00_DATA_out15	1'd1
156	—	—	—	I2S00_DATA_out16	1'd1
157	—	—	—	I2S00_DATA_out17	1'd1
158	—	—	—	I2S00_DATA_out18	1'd1
159	—	—	—	I2S00_DATA_out19	1'd1
160	—	—	—	I2S00_DATA_out20	1'd1
161	—	—	—	I2S00_DATA_out21	1'd1
162	—	—	—	I2S00_DATA_out22	1'd1
163	—	—	—	I2S00_DATA_out23	1'd1
164	I2S1I_BCK_in	0	no	I2S1I_BCK_out	1'd1
165	I2S1I_WS_in	0	no	I2S1I_WS_out	1'd1
166	I2S1I_DATA_in0	0	no	I2S10_DATA_out0	1'd1
167	I2S1I_DATA_in1	0	no	I2S10_DATA_out1	1'd1
168	I2S1I_DATA_in2	0	no	I2S10_DATA_out2	1'd1
169	I2S1I_DATA_in3	0	no	I2S10_DATA_out3	1'd1
170	I2S1I_DATA_in4	0	no	I2S10_DATA_out4	1'd1
171	I2S1I_DATA_in5	0	no	I2S10_DATA_out5	1'd1
172	I2S1I_DATA_in6	0	no	I2S10_DATA_out6	1'd1
173	I2S1I_DATA_in7	0	no	I2S10_DATA_out7	1'd1
174	I2S1I_DATA_in8	0	no	I2S10_DATA_out8	1'd1
175	I2S1I_DATA_in9	0	no	I2S10_DATA_out9	1'd1

Signal No.	Input Signals	Default Value If Unassigned*	Same Input Signal from IO_MUX Core	Output Signals	Output Enable of Output Signals
176	I2S1I_DATA_in10	0	no	I2S1O_DATA_out10	1'd1
177	I2S1I_DATA_in11	0	no	I2S1O_DATA_out11	1'd1
178	I2S1I_DATA_in12	0	no	I2S1O_DATA_out12	1'd1
179	I2S1I_DATA_in13	0	no	I2S1O_DATA_out13	1'd1
180	I2S1I_DATA_in14	0	no	I2S1O_DATA_out14	1'd1
181	I2S1I_DATA_in15	0	no	I2S1O_DATA_out15	1'd1
182	—	—	—	I2S1O_DATA_out16	1'd1
183	—	—	—	I2S1O_DATA_out17	1'd1
184	—	—	—	I2S1O_DATA_out18	1'd1
185	—	—	—	I2S1O_DATA_out19	1'd1
186	—	—	—	I2S1O_DATA_out20	1'd1
187	—	—	—	I2S1O_DATA_out21	1'd1
188	—	—	—	I2S1O_DATA_out22	1'd1
189	—	—	—	I2S1O_DATA_out23	1'd1
190	I2SOI_H_SYNC	0	no	pwm3_out1h	1'd1
191	I2SOI_V_SYNC	0	no	pwm3_out1l	1'd1
192	I2SOI_H_ENABLE	0	no	pwm3_out2h	1'd1
193	I2SI_H_SYNC	0	no	pwm3_out2l	1'd1
194	I2SI_V_SYNC	0	no	pwm3_out3h	1'd1
195	I2SI_H_ENABLE	0	no	pwm3_out3l	1'd1
196	—	—	—	pwm3_out4h	1'd1
197	—	—	—	pwm3_out4l	1'd1
198	U2RXD_in	0	yes	U2TXD_out	1'd1
199	U2CTS_in	0	yes	U2RTS_out	1'd1
200	<a href="#">emac_mdc_i</a>	0	no	<a href="#">emac_mdc_o</a>	<a href="#">emac_mdc_oe</a>
201	<a href="#">emac_mdi_i</a>	0	no	<a href="#">emac_mdo_o</a>	<a href="#">emac_mdo_o_e</a>
202	<a href="#">emac_crs_i</a>	0	no	<a href="#">emac_crs_o</a>	<a href="#">emac_crs_oe</a>
203	<a href="#">emac_col_i</a>	0	no	<a href="#">emac_col_o</a>	<a href="#">emac_col_oe</a>
204	pcmfsync_in	0	no	bt_audio0_irq	1'd1
205	pcmclk_in	0	no	bt_audio1_irq	1'd1
206	pcmdin	0	no	bt_audio2_irq	1'd1
207	—	—	—	ble_audio0_irq	1'd1
208	—	—	—	ble_audio1_irq	1'd1
209	—	—	—	ble_audio2_irq	1'd1
210	—	—	—	pcmfsync_out	pcmfsync_en
211	—	—	—	pcmclk_out	pcmclk_en
212	—	—	—	pcmdout	pcmdout_en
213	—	—	—	ble_audio_sync0_p	1'd1
214	—	—	—	ble_audio_sync1_p	1'd1
215	—	—	—	ble_audio_sync2_p	1'd1
224	—	—	—	sig_in_func224	1'd1

Signal No.	Input Signals	Default Value If Unassigned*	Same Input Signal from IO_MUX Core	Output Signals	Output Enable of Output Signals
225	—	—	—	sig_in_func225	1'd1
226	—	—	—	sig_in_func226	1'd1
227	—	—	—	sig_in_func227	1'd1
228	—	—	—	sig_in_func228	1'd1

### A.3. Ethernet\_MAC

Table 5-3. Ethernet\_MAC

Pin Name	Function6	MII (int_osc)	MII (ext_osc)	RMII (int_osc)	RMII (ext_osc)
GPIO0	EMAC_TX_CLK	TX_CLK (I)	TX_CLK (I)	CLK_OUT(O)	EXT_OSC_CLK(I)
GPIO5	EMAC_RX_CLK	RX_CLK (I)	RX_CLK (I)	—	—
GPIO21	EMAC_TX_EN	TX_EN(O)	TX_EN(O)	TX_EN(O)	TX_EN(O)
GPIO19	EMAC_TXD0	TXD[0](O)	TXD[0](O)	TXD[0](O)	TXD[0](O)
GPIO22	EMAC_TXD1	TXD[1](O)	TXD[1](O)	TXD[1](O)	TXD[1](O)
MTMS	EMAC_TXD2	TXD[2](O)	TXD[2](O)	—	—
MTDI	EMAC_TXD3	TXD[3](O)	TXD[3](O)	—	—
MTCK	EMAC_RX_ER	RX_ER(I)	RX_ER(I)	—	—
GPIO27	EMAC_RX_DV	RX_DV(I)	RX_DV(I)	CRS_DV(I)	CRS_DV(I)
GPIO25	EMAC_RXD0	RXD[0](I)	RXD[0](I)	RXD[0](I)	RXD[0](I)
GPIO26	EMAC_RXD1	RXD[1](I)	RXD[1](I)	RXD[1](I)	RXD[1](I)
UOTXD	EMAC_RXD2	RXD[2](I)	RXD[2](I)	—	—
MTDO	EMAC_RXD3	RXD[3](I)	RXD[3](I)	—	—
GPIO16	EMAC_CLK_OUT	CLK_OUT(O)	—	CLK_OUT(O)	—
GPIO17	EMAC_CLK_OUT_180	CLK_OUT_180(O)	—	CLK_OUT_180(O)	—
GPIO4	EMAC_TX_ER	TX_ERR(O)*	TX_ERR(O)*	—	—
In GPIO Matrix*	—	MDC(O)	MDC(O)	MDC(O)	MDC(O)
In GPIO Matrix*	—	MDIO(IO)	MDIO(IO)	MDIO(IO)	MDIO(IO)
In GPIO Matrix*	—	CRS(I)	CRS(I)	—	—
In GPIO Matrix*	—	COL(I)	COL(I)	—	—

\*Notes: 1. The GPIO Matrix can be any GPIO. 2. The TX\_ERR (O) is optional.

### A.4. IO\_MUX

For the list of IO\_MUX pins, please see the next page.

IO\_MUX

Pin No.	Power Supply Pin	Analog Pin	Digital Pin	Power Domain	Analog Function0	Analog Function1	Analog Function2	RTC Function0	RTC Function1	Function0	Type	Function1	Type	Function2	Type	Function3	Type	Function4	Type
1				VDDA supply in															
2	VDDA	LVA_IN		VDD3P3															
3	VDD3P3			VDD3P3 supply in															
4	VDD3P3			VDD3P3 supply in															
5		SENSOR_VP		VDD3P3_RTC	ADC1_CH0			RTC_GPIO0		GPIO8	I			GPIO36	I				
6		SENSOR_CAPP		VDD3P3_RTC	ADC1_CH1			RTC_GPIO1		GPIO7	I			GPIO37	I				
7		SENSOR_CAPN		VDD3P3_RTC	ADC1_CH2			RTC_GPIO2		GPIO8	I			GPIO38	I				
8		SENSOR_VN		VDD3P3_RTC	ADC1_CH3			RTC_GPIO3		GPIO9	I			GPIO39	I				
9		CHIP_PU		VDD3P3_RTC															
10		VDET1		VDD3P3_RTC	ADC1_CH6			RTC_GPIO4		GPIO4	I			GPIO34	I				
11		VDET2		VDD3P3_RTC	ADC1_CH7			RTC_GPIO5		GPIO5	I			GPIO35	I				
12		32K_XP		VDD3P3_RTC	XTAL_32K_P	ADC1_CH4	TOUCH9	RTC_GPIO9		GPIO32	I/O/T			GPIO32	I/O/T				
13		32K_XN		VDD3P3_RTC	XTAL_32K_N	ADC1_CH5	TOUCH8	RTC_GPIO8		GPIO33	I/O/T			GPIO33	I/O/T				
14				VDD3P3_RTC	DAC_1	ADC2_CH8		RTC_GPIO6		GPIO25	I/O/T			GPIO25	I/O/T				
15				VDD3P3_RTC	DAC_2	ADC2_CH9		RTC_GPIO7		GPIO26	I/O/T			GPIO26	I/O/T				
16				VDD3P3_RTC		ADC2_CH7	TOUCH7	RTC_GPIO7		GPIO27	I/O/T			GPIO27	I/O/T				
17				VDD3P3_RTC		ADC2_CH6	TOUCH6	RTC_GPIO6		GPIO27	I/O/T			GPIO27	I/O/T				
18				VDD3P3_RTC		ADC2_CH5	TOUCH5	RTC_GPIO5		GPIO27	I/O/T			GPIO27	I/O/T				
19	VDD3P3_RTC			VDD3P3_RTC supply in															
20				VDD3P3_RTC		ADC2_CH4	TOUCH4	RTC_GPIO4		GPIO27	I/O/T			GPIO27	I/O/T				
21				VDD3P3_RTC		ADC2_CH3	TOUCH3	RTC_GPIO3	IEC_SDA	GPIO2	I/O/T			GPIO15	I/O/T	HSZ_DATA3	I/O/O/T	SD_DATA3	I/O/O/T
22				VDD3P3_RTC		ADC2_CH2	TOUCH2	RTC_GPIO2	IEC_SCL	GPIO2	I/O/T			GPIO2	I/O/T	HSZ_OMD	I/O/O/T	SD_OMD	I/O/O/T
23				VDD3P3_RTC		ADC2_CH1	TOUCH1	RTC_GPIO1	IEC_SDA	GPIO0	I/O/T			GPIO2	I/O/T	HSZ_DATA0	I/O/O/T	SD_DATA0	I/O/O/T
24				VDD3P3_RTC		ADC2_CH0	TOUCH0	RTC_GPIO0	IEC_SCL	GPIO4	I/O/T			GPIO0	I/O/T	HSZ_DATA1	I/O/O/T	SD_DATA1	I/O/O/T
25				VDD_SDD0						GPIO16	I/O/T			GPIO16	I/O/T	HSI_DATA4	I/O/O/T	U2RXD	I/O/O/T
26	VDD_SDD0			VDD_SDD0 supply out/in															
27				VDD_SDD0						GPIO17	I/O/T			GPIO17	I/O/T	HSI_DATA5	I/O/O/T	U2TXD	I/O/O/T
28				VDD_SDD0	SD_DATA_2					SD_DATA2	I/O/T	SPHD	I/O/T	GPIO9	I/O/T	HSI_DATA2	I/O/O/T	U1RXD	I/O/O/T
29				VDD_SDD0	SD_DATA_3					SD_DATA3	I/O/O/T	SPWP	I/O/T	GPIO10	I/O/T	HSI_DATA3	I/O/O/T	U1TXD	I/O/O/T
30				VDD_SDD0						SD_OMD	I/O/O/T	SPCSO	I/O/T	GPIO11	I/O/T	HSI_OMD	I/O/O/T	UIRFS	I/O/O/T
31				VDD_SDD0						SD_CLK	I/O	SPICK	I/O/T	GPIO6	I/O/T	HSI_CLK	I/O/O/T	UICTS	I/O/O/T
32				VDD_SDD0						SD_DATA_0	I/O/O/T	SPID	I/O/T	GPIO7	I/O/T	HSI_DATA0	I/O/O/T	UIRFS	I/O/O/T
33				VDD_SDD0						SD_DATA_1	I/O/O/T	SPID	I/O/T	GPIO8	I/O/T	HSI_DATA1	I/O/O/T	UIRFS	I/O/O/T
34				VDD3P3_CPU						GPIO5	I/O/T	VSPICSO	I/O/T	GPIO5	I/O/T	HSI_DATA6	I/O/O/T	URECTS	I/O/O/T
35				VDD3P3_CPU						GPIO18	I/O/T	VSPICKL	I/O/T	GPIO18	I/O/T	HSI_DATA7	I/O/O/T		
36				VDD3P3_CPU						GPIO23	I/O/T	VSPID	I/O/T	GPIO23	I/O/T	HSI_STROBE	I/O/O/T		
37	VDD3P3_CPU			VDD3P3_CPU supply in															
38				VDD3P3_CPU						GPIO19	I/O/T	VSPID	I/O/T	GPIO19	I/O/T	U0CTS	I/O/O/T		
39				VDD3P3_CPU						GPIO22	I/O/T	VSPWP	I/O/T	GPIO22	I/O/T	U0RFS	I/O/O/T		
40				VDD3P3_CPU						U0RXD	I/O	CLK_OUT2	O	GPIO3	I/O/T				
41				VDD3P3_CPU						U0TXD	O	CLK_OUT3	O	GPIO3	I/O/T				
42				VDD3P3_CPU						GPIO21	I/O/T	VSPHMD	I/O/T	GPIO21	I/O/T				
43	VDDA			VDDA supply in															
44		XTAL_N		VDDA															
45		XTAL_P		VDDA															
46	VDDA			VDDA supply in															
47		CAP2		VDDA															
48		CAP1		VDDA															
Total Number	8	14	28																

Notes:

- wpu: weak pull-up;
- wpd: weak pull-down;
- ie: input enable;
- oe: output enable;
- Please see Table: Notes on ESP32 Pin Lists for more information. (请参考: 管脚清单说明。)

## Revision History

Date	Version	Release notes
2024.02	v4.5	Section <a href="#">2.3.2 Chip Power-up and Reset</a> : Updated the link to the VDD_SDIO 1.8 V circuit design to <i>ESP32 Hardware Design Guidelines</i>
2023.12	v4.4	Table <a href="#">1-1 Comparison</a> : Added information about flash under the table
2023.07	v4.3	<ul style="list-style-type: none"> <li>• Updated formatting throughout the document</li> <li>• Updated wording in some sections</li> <li>• Added a new section <a href="#">2.2.1 Restrictions for GPIOs and RTC_GPIOs</a></li> <li>• Added a new section <a href="#">3.1.5 Cache</a></li> </ul>
2023.01	v4.2	<ul style="list-style-type: none"> <li>• Removed contents about hall sensor according to <a href="#">PCN20221202</a></li> <li>• Section <a href="#">3.9.3 Touch Sensor</a>: Added a note about limited applications of touch sensor</li> </ul>
2022.12	v4.1	<ul style="list-style-type: none"> <li>• Section <a href="#">3.1.1 CPU</a>: Added link to <i>Xtensa® Instruction Set Architecture (ISA) Summary</i></li> <li>• Table <a href="#">1-1 Comparison</a>: Updated the description about chip revision upgrade</li> </ul>
2022.10	v4.0	<ul style="list-style-type: none"> <li>• Section <a href="#">Product Overview</a>: Updated the description</li> <li>• Table <a href="#">2-6 Pin Mapping Between Chip and Flash/PSRAM</a>: Added two notes below the table</li> <li>• Section <a href="#">2.3.1 Power Scheme</a>: Added a new item to “Notes on power supply”</li> <li>• Updated Figure <a href="#">1-1 ESP32 Series Nomenclature</a></li> <li>• Table <a href="#">1-1 Comparison</a>: Added a new column “VDD_SDIO Voltage”</li> <li>• Section <a href="#">3.8.12 TWAI® Controller</a>: Updated the bit rates</li> <li>• Added <a href="#">Not Recommended for New Designs (NRND)</a> label to ESP32-S0WD</li> </ul>
2022.03	v3.9	<ul style="list-style-type: none"> <li>• Added a new chip variant ESP32-D0WDR2-V3</li> <li>• Added Table <a href="#">2-5 Pin Mapping Between Chip and Flash/PSRAM</a> and Table <a href="#">2-6 Pin Mapping Between Chip and Flash/PSRAM</a></li> <li>• Updated Figure <a href="#">5-2 QFN48 (5×5 mm) Package</a></li> <li>• Updated Appendix <a href="#">IO_MUX</a></li> <li>• Updated Table <a href="#">3-6 Peripheral Pin Configurations</a></li> <li>• Section <a href="#">3 Functional Description</a>: Added links to <i>ESP32 Technical Reference Manual</i></li> </ul>

Cont'd on next page

## Cont'd from previous page

Date	Version	Release notes
2021.10	v3.8	<ul style="list-style-type: none"> <li>Upgraded ESP32-U4WDH variant from single-core to dual-core, see <a href="#">PCN-2021-021</a>. The single-core version coexists with the new dual-core version around December 2, 2021. The physical product is subject to batch tracking.</li> <li>Section <a href="#">CPU and Memory</a>: Added CoreMark® score</li> <li>Section <a href="#">3.8.12 TWAI® Controller</a>: Updated the description</li> <li>Added <a href="#">Not Recommended for New Designs (NRND)</a> label to the ESP32-D0WDQ6-V3 variant</li> <li>Section <a href="#">5 Packaging</a>: Provided a link to <a href="#">Espressif Chip Package Information</a></li> <li>Updated Section <a href="#">Bluetooth</a></li> </ul>
2021.07	v3.7	<ul style="list-style-type: none"> <li>Removed ESP32-D2WD variant</li> <li>Section <a href="#">3.7.1 Bluetooth Radio and Baseband</a>: Updated wording</li> <li>Updated pin function numbers starting from Function0</li> <li>Added <a href="#">Not Recommended for New Designs (NRND)</a> label to ESP32-D0WD and ESP32-D0WDQ6 variants</li> </ul>
2021.03	V3.6	<ul style="list-style-type: none"> <li>Updated Figure <a href="#">Block Diagram</a></li> <li>Updated Table <a href="#">4-5 Reliability</a></li> <li>Updated Figure <a href="#">2-3 ESP32 Power Scheme</a></li> <li>Updated Table <a href="#">4-2 Recommended Power Supply Characteristics</a></li> <li>Updated the notes below Table <a href="#">2-2 Description of Timing Parameters for Power-up and Reset</a></li> <li>Table <a href="#">3-1, 3-6</a>, Section <a href="#">3.8.12</a>: Added more information about TWAI®</li> </ul>
2021.01	V3.5	<ul style="list-style-type: none"> <li>Table <a href="#">2-1 Pin Overview</a>: Updated the description for CAP2 from 3 nF to 3.3 nF</li> <li>Section <a href="#">Advanced Peripheral Interfaces</a>: Added TWAI®</li> <li>Updated Figure <a href="#">Block Diagram</a></li> <li>Appendix <a href="#">IO_MUX</a>: Updated the reset values for MTCK, MTMS, GPIO27</li> </ul>
2020.04	V3.4	<ul style="list-style-type: none"> <li>Added one chip variant: ESP32-U4WDH</li> <li>Updated some figures in Table <a href="#">3-2, 4-6, 4-7, 4-9, 4-11, 4-12</a></li> <li>Table <a href="#">4-7 Receiver –Basic Data Rate</a>: Added a note under the table</li> </ul>
2020.01	V3.3	<ul style="list-style-type: none"> <li>Added two chip variants: ESP32-D0WD-V3 and ESP32-D0WDQ6-V3.</li> <li>Added a note under Table <a href="#">3-3 Analog-to-Digital Converter (ADC)</a></li> </ul>

Cont'd on next page

## Cont'd from previous page

Date	Version	Release notes
2019.10	V3.2	<ul style="list-style-type: none"> <li>Updated Figure <a href="#">2-4 Visualization of Timing Parameters for Power-up and Reset</a></li> </ul>
2019.07	V3.1	<ul style="list-style-type: none"> <li>Table <a href="#">2-1 Pin Overview</a>: Added pin-pin mapping between ESP32-D2WD and the in-package flash under the table</li> <li>Updated Figure <a href="#">1-1 ESP32 Series Nomenclature</a></li> </ul>
2019.04	V3.0	<ul style="list-style-type: none"> <li>Section <a href="#">2.4 Strapping Pins</a>: Added information about the setup and hold times for the strapping pins</li> </ul>
2019.02	V2.9	<ul style="list-style-type: none"> <li>Table <a href="#">2-1 Pin Overview</a>: Applied new formatting</li> <li>Table <a href="#">3-6 Peripheral Pin Configurations</a>: Fixed typos with respect to the ADC1 channel mappings</li> </ul>
2019.01	V2.8	<ul style="list-style-type: none"> <li>Changed the RF power control range in Table <a href="#">4-7</a>, <a href="#">4-10</a>, and <a href="#">4-12</a> from -12 ~ +12 to -12 ~ +9 dBm;</li> <li>Small text changes</li> </ul>
2018.11	V2.7	<ul style="list-style-type: none"> <li>Updated Section <a href="#">Applications</a></li> <li>Table <a href="#">IO_MUX</a>: Updated pin statuses at reset and after reset</li> </ul>
2018.10	V2.6	<ul style="list-style-type: none"> <li>Section <a href="#">5 Packaging</a>: Updated QFN package drawings</li> </ul>
2018.08	V2.5	<ul style="list-style-type: none"> <li>Table <a href="#">4-1 Absolute Maximum Ratings</a>: Added "Cumulative IO output current"</li> <li>Table <a href="#">4-3 DC Characteristics (3.3 V, 25 °C)</a>: Added more parameters</li> <li>Appendix <a href="#">IO_MUX</a>: Changed the power domain names to be consistent with the pin names</li> </ul>
2018.07	V2.4	<ul style="list-style-type: none"> <li>Deleted information on Packet Traffic Arbitration (PTA);</li> <li>Added Figure <a href="#">2-4 Visualization of Timing Parameters for Power-up and Reset</a></li> <li>Table <a href="#">3-2 Power Management Unit (PMU)</a>: Added the current consumption figures for dual-core SoCs</li> <li>Updated Section <a href="#">3.9.1 Analog-to-Digital Converter (ADC)</a></li> </ul>

Cont'd on next page

## Cont'd from previous page

Date	Version	Release notes
2018.06	V2.3	<ul style="list-style-type: none"> <li>Table 3-2 Power Management Unit (PMU): Added the current consumption figures at CPU frequency of 160 MHz</li> </ul>
2018.05	V2.2	<ul style="list-style-type: none"> <li>Table 2-1 Pin Overview: Changed the voltage range of VDD3P3_RTC from 1.8-3.6 V to 2.3-3.6 V</li> <li>Updated Section 2.3.1 Power Scheme</li> <li>Updated Section 3.1.3 External Flash and RAM</li> <li>Updated Table 3-2 Power Management Unit (PMU)</li> <li>Removed content about temperature sensor;</li> </ul> <p>Changes to electrical characteristics:</p> <ul style="list-style-type: none"> <li>Updated Table 4-1 Absolute Maximum Ratings</li> <li>Added Table 4-2 Recommended Power Supply Characteristics</li> <li>Added Table 4-3 DC Characteristics (3.3 V, 25 °C)</li> <li>Added Table 4-5 Reliability</li> <li>Table 4-7 Receiver –Basic Data Rate: Updated the values of "Gain control step" and "Adjacent channel transmit power"</li> <li>Table 4-10 Transmitter –Enhanced Data Rate: Updated the values of "Gain control step", "<math>\pi/4</math> DQPSK modulation accuracy", "8 DPSK modulation accuracy", and "In-band spurious emissions"</li> <li>Table 4-12 Transmitter: Updated the values of "Gain control step" and "Adjacent channel transmit power"</li> </ul>
2018.01	V2.1	<ul style="list-style-type: none"> <li>Deleted software-specific features;</li> <li>Deleted information on LNA pre-amplifier;</li> <li>Specified the CPU speed and flash speed of ESP32-D2WD;</li> <li>Section 2.3.1 Power Scheme: Added notes</li> </ul>
2017.12	V2.0	<ul style="list-style-type: none"> <li>Section 5 Packaging: Added a note on the sequence of pin number</li> </ul>
2017.10	V1.9	<ul style="list-style-type: none"> <li>Table 2-1 Pin Overview: Updated the description of pin CHIP_PU</li> <li>Section 2.3.1 Power Scheme: Added a note</li> <li>Section 2.4 Strapping Pins: Updated the description of the chip's system reset</li> <li>Section 3.6.4 Wi-Fi Radio and Baseband: Added a description of antenna diversity and selection</li> <li>Table 3-2 Power Management Unit (PMU): Deleted "Association sleep pattern", added notes to Active sleep and Modem-sleep</li> </ul>

Cont'd on next page

## Cont'd from previous page

Date	Version	Release notes
2017.08	V1.8	<ul style="list-style-type: none"> <li>● Added <a href="#">Table 3-6 Peripheral Pin Configurations</a></li> <li>● Figure <a href="#">Block Diagram</a>: Corrected a typo</li> </ul>
2017.08	V1.7	<ul style="list-style-type: none"> <li>● Section <a href="#">Bluetooth</a>: Changed the transmitting power to +12 dBm; the sensitivity of NZIF receiver to -97 dBm</li> <li>● Table <a href="#">2-1 Pin Overview</a>: Added a note</li> <li>● section <a href="#">3.1.1 CPU</a>: Added 160 MHz clock frequency</li> <li>● Section <a href="#">3.6.4 Wi-Fi Radio and Baseband</a>: Changed the transmitting power from 21 dBm to 20.5 dBm</li> <li>● Section <a href="#">3.7.1 Bluetooth Radio and Baseband</a>: Changed the dynamic control range of class-1, class-2 and class-3 transmit output powers to "up to 24 dBm"; changed the dynamic range of NZIF receiver sensitivity to "over 97 dB"</li> <li>● Table <a href="#">3-2 Power Management Unit (PMU)</a>: Added two notes</li> <li>● Updated Section <a href="#">3.8.1 General Purpose Input / Output Interface (GPIO)</a></li> <li>● Updated Section <a href="#">3.8.11 SDIO/SPI Slave Controller</a></li> <li>● Updated Table <a href="#">4-1 Absolute Maximum Ratings</a></li> <li>● Table <a href="#">4.4 RF Current Consumption in Active Mode</a>: Changed the duty cycle on which the transmitters' measurements are based to 50%.</li> <li>● Table <a href="#">4-6 Wi-Fi Radio</a>: Added a note on "Output impedance"</li> <li>● Table <a href="#">4-7, 4-9, 4-11</a>: Updated parameter "Sensitivity"</li> <li>● Table <a href="#">4-7, 4-10, 4-12</a>: Updated parameters "RF transmit power" and "RF power control range"; added parameter "Gain control step"</li> <li>● Deleted Chapters: "Touch Sensor" and "Code Examples";</li> <li>● Added a link to <a href="#">certification download</a>.</li> </ul>
2017.06	V1.6	<ul style="list-style-type: none"> <li>● Section <a href="#">Complete Integration Solution</a>: Changed the number of external components to 20</li> <li>● Section <a href="#">3.8.1 General Purpose Input / Output Interface (GPIO)</a>: Changed the number of GPIO pins to 34</li> </ul>
2017.06	V1.5	<ul style="list-style-type: none"> <li>● Section <a href="#">CPU and Memory</a>: Changed the power supply range</li> <li>● Section <a href="#">2.3.1 Power Scheme</a>: Updated the note</li> <li>● Updated Table <a href="#">4-1 Absolute Maximum Ratings</a></li> <li>● Table <a href="#">Notes on ESP32 Pin Lists</a>: Changed the drive strength values of the digital output pins in Note 8</li> <li>● Added the option to subscribe for notifications of documentation changes</li> </ul>

Cont'd on next page

## Cont'd from previous page

Date	Version	Release notes
2017.05	V1.4	<ul style="list-style-type: none"> <li>• Section <a href="#">Clocks and Timers</a>: Added a note to the frequency of the external crystal oscillator</li> <li>• Section <a href="#">2.4 Strapping Pins</a>: Added a note</li> <li>• Updated Section <a href="#">3.3 RTC and Low-power Management</a></li> <li>• Table <a href="#">4-1 Absolute Maximum Ratings</a>: Changed the maximum driving capability from 12 mA to 80 mA</li> <li>• Table <a href="#">4-6 Wi-Fi Radio</a>: Changed the input impedance value of 50Ω to output impedance value of 30+j10 Ω</li> <li>• Table <a href="#">Notes on ESP32 Pin Lists</a>: Added a note to No.8</li> <li>• Table <a href="#">IO_MUX</a>: Deleted GPIO20</li> </ul>
2017.04	V1.3	<ul style="list-style-type: none"> <li>• Added Appendix <a href="#">Notes on ESP32 Pin Lists</a></li> <li>• Updated Table <a href="#">4-6 Wi-Fi Radio</a></li> <li>• Updated Figure <a href="#">2-2 ESP32 Pin Layout (QFN 5*5, Top View)</a></li> </ul>
2017.03	V1.2	<ul style="list-style-type: none"> <li>• Table <a href="#">2-1 Pin Overview</a>: Added a note</li> <li>• Section <a href="#">3.1.2 Internal Memory</a>: Updated the note</li> </ul>
2017.02	V1.1	<ul style="list-style-type: none"> <li>• Added Section <a href="#">1 ESP32 Series Comparison</a></li> <li>• Updated Section <a href="#">MCU and Advanced Features</a></li> <li>• Updated Section <a href="#">Block Diagram</a></li> <li>• Updated Section <a href="#">2 Pins</a></li> <li>• Updated Section <a href="#">CPU and Memory</a></li> <li>• Updated Section <a href="#">3.2.3 Audio PLL Clock</a></li> <li>• Updated Section <a href="#">4.1 Absolute Maximum Ratings</a></li> <li>• Updated Section <a href="#">5 Packaging</a></li> <li>• Updated Section <a href="#">Related Documentation and Resources</a></li> </ul>
2016.08	V1.0	First release.



[www.espressif.com](http://www.espressif.com)

## Disclaimer and Copyright Notice

Information in this document, including URL references, is subject to change without notice.

ALL THIRD PARTY' S INFORMATION IN THIS DOCUMENT IS PROVIDED AS IS WITH NO WARRANTIES TO ITS AUTHENTICITY AND ACCURACY.

NO WARRANTY IS PROVIDED TO THIS DOCUMENT FOR ITS MERCHANTABILITY, NON-INFRINGEMENT, FITNESS FOR ANY PARTICULAR PURPOSE, NOR DOES ANY WARRANTY OTHERWISE ARISING OUT OF ANY PROPOSAL, SPECIFICATION OR SAMPLE.

All liability, including liability for infringement of any proprietary rights, relating to use of information in this document is disclaimed. No licenses express or implied, by estoppel or otherwise, to any intellectual property rights are granted herein.



The Wi-Fi Alliance Member logo is a trademark of the Wi-Fi Alliance. The Bluetooth logo is a registered trademark of Bluetooth SIG.

All trade names, trademarks and registered trademarks mentioned in this document are property of their respective owners, and are hereby acknowledged.





Copyright © 2024 Espressif Systems (Shanghai) Co., Ltd. All rights reserved.

## Looking for pricing, stock, or lifecycle information?

Click below to explore more details on WIN SOURCE:

-  [View ESP32-WROOM-32-N8 on WIN SOURCE](#)
-  [Espressif Information](#)

## Optimize Your Supply Chain with WIN SOURCE Solutions

-  Global Sourcing Solution
-  Obsolete Management
-  Cost Control Management
-  Shortage Management
-  Alternative Solution
-  Excess Inventory Management