



# THE DATASHEET OF RA-01SH





# Ra-01SH SPECIFICATION

Version V1.1

Copyright ©2020

## Disclaimer and copyright notice

The information in this article, including the URL address for reference, is subject to change without notice.

The document is provided "as is" without any guarantee responsibility, including any guarantee for marketability, suitability for a specific purpose, or non-infringement, and any guarantee mentioned elsewhere in any proposal, specification or sample. This document does not take any responsibility, including the responsibility for infringement of any patent rights caused by using the information in this document. This document does not grant any license for the use of intellectual property rights by estoppel or other means, whether express or implied.

The test data obtained in the article are all obtained from Anxinke's laboratory tests, and the actual results may vary slightly.

All brand names, trademarks and registered trademarks mentioned in this article are the property of their respective owners, and it is hereby declared.

The final interpretation right belongs to Shenzhen Anxinke Technology Co., Ltd.

## Notice

Due to product version upgrades or other reasons, the contents of this manual may change. Shenzhen Anxinke Technology Co., Ltd. reserves the right to modify the contents of this manual without any notice or prompt. This manual is only used as a guide. Shenzhen Anxinke Technology Co., Ltd. makes every effort to provide accurate information in this manual. However, Shenzhen Anxinke Technology Co., Ltd. does not guarantee that the contents of the manual are completely free from errors. All statements and information in this manual And suggestions do not constitute any express or implied guarantee.



---

CONTENT

1. PRODUCT DESCRIPTION.....	5
2.ELECTRICAL PARAMETERS.....	7
3.DIMENSION.....	10
4.PIN DEFINITION.....	11
5. SCHEMATIC DIAGRAM.....	12
6.DESIGN GUIDE.....	13
8.PACKAGE.....	17
9.CONTACT US.....	17

## 1. PRODUCT DESCRIPTION

Anxinke LoRa series modules (Ra-01SH) are designed and developed by Anxinke Technology. This module is used for ultra-long-distance spread-spectrum communication. Its radio chip SX1262 mainly uses LoRa™ remote modem for ultra-long-distance spread-spectrum communication. It has strong anti-interference and can minimize current consumption. With SEMTECH's LoRa™ patented modulation technology, SX1262 has a high sensitivity of over -148dBm, a power output of +22dBm, a long transmission distance and high reliability. At the same time, compared to traditional modulation technology, LoRa™ modulation technology also has obvious advantages in anti-blocking and selection, which solves the problem of distance, anti-interference and power consumption that traditional design solutions cannot simultaneously take into account.

Application areas are used in automatic meter reading, home building automation, security systems, and remote irrigation systems.

### Features

- LoRa™ modem
- Support FSK, GFSK, MSK, GMSK, LoRa™ and OOK modulation methods
- Support frequency band 803MHz~930MHz
- Working voltage is 3.3V, maximum output is +22dBm, maximum working current is 140mA
- Low power consumption characteristics in receiving state, the minimum receiving current is 4.2 mA, standby current is 1.6mA
- High sensitivity: as low as -140dBm
- Small volume dual row stamp hole patch package
- The module adopts SPI interface, half-duplex communication, with CRC, up to 256-byte packet engine

## Main parameters

**List 1 Main parameter description**

<b>Model</b>	Ra-01SH
<b>Package</b>	SMD16
<b>Size</b>	17*16*3.2(±0.2)MM
<b>Antenna</b>	Compatible with half-hole pads/through-hole pads (need to solder the antenna)/IPEX socket
<b>Spectrum range</b>	803MHz~930MHz
<b>Operating temperature</b>	-40 °C ~ 85 °C
<b>Storage environment</b>	-40 °C ~ 125 °C , < 90%RH
<b>Power supply</b>	2.7~3.6V, default 3.3V, current > 200mA
<b>Interface</b>	SPI
<b>Programmable bit rate</b>	Up to 300kbps
<b>Certificate</b>	/

## 2.ELECTRICAL PARAMETERS

*Ra-01SH series modules are electrostatic sensitive devices, special precautions need to be taken when handling*



prompt:

The Ra-01SH module is an electrostatic sensitive device (ESD), which requires special ESD precautions, and should usually be applied to ESD sensitive components. The correct ESD handling and packaging procedures must be adopted during the entire handling, transportation and

operation of any application combined with the Ra-01SH module. Do not touch the module with your hands or use a non-antistatic soldering iron for soldering to avoid damage to the module.

## Electrical characteristics

Parameter	Name	Min	Typical	Max	Unit
Working temperature	TOPR	-40	25	85	°C
Voltage	VDD	2.7	3.3	3.6	V

## Digital port characteristics

Description		Typical		Unit	
Working frequency		410~525		MHz	
Port	Name	Min	Typical	Max	Unit
IO level	VIO	2.7	3.3	3.6	V
Input logic level is low	VIL	-	-	0.2	V
Input logic level is high	VIH	0.8	-	-	V
Output logic level is low	VOL	-	-	0.1	V
Output logic level is high	VOH	0.9	-	-	V

## ·SPI Interface characteristics

symbol	Description	Condition	Mix	Typical	Max	Unit
Fsck	SCK frequency	-	-	-	10	MH Z
tch	SCK high time	-	50	-	-	ns
tcl	SCK low time	-	50	-	-	ns
trise	SCK rise time	-	-	5	-	ns
tfall	SCK fall time	-	-	5	-	ns
tsetup	MOSI establishment time	From MOSI change to SCK rising edge	30	-	-	ns
thold	MOSI maintenance time	Change from rising edge of SCK to MOSI	20	-	-	ns
tnsetup	NSS establishment time	From NSS falling edge to SCK rising edge	30	-	-	ns
tnhold	NSS maintenance time	From SCK falling edge to NSS rising edge, normal mode	100	-	-	ns
tnhigh	NSS high time between spi visits	-	20	-	-	ns
T_DATA	DATA maintenance and establishment time	-	250	-	-	ns

### 3.DIMENSION

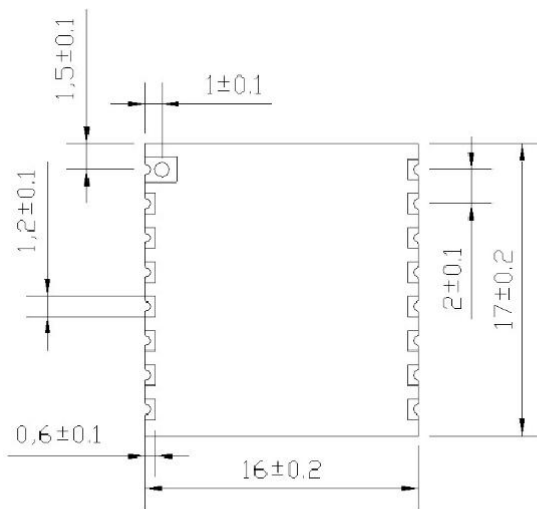
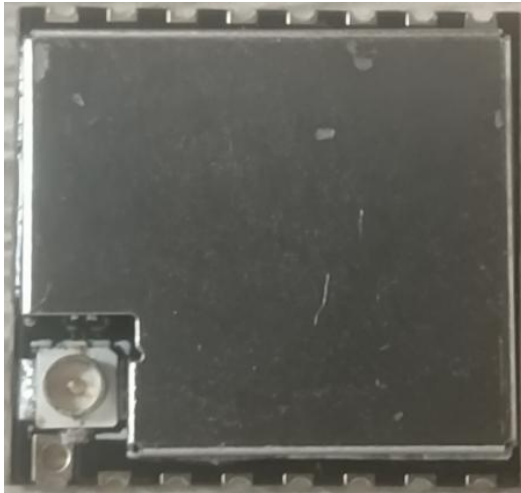

正面

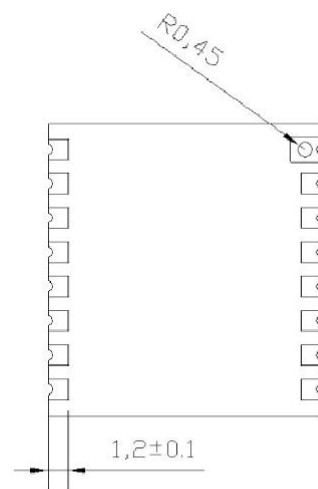

背面

## 4.PIN DEFINITION

The Ra-01SH module has a total of 16 interfaces. As shown in the pin diagram, the pin function definition table is the interface definition.



Ra-01SH Pin diagram

PIN function definition

No.	Name	Function description
1	ANT	Connect the antenna
2	GND	Ground
3	3.3V	Typical 3.3V power supply
4	RESET	Reset
5	TXEN	RF control port
6	DIO1	Digital IO1 software configuration
7	DIO2	Digital IO2 software configuration
8	DIO3	Digital IO3 software configuration
9	GND	Ground
10	BUSY	Status indicator
11	RXEN	RF control port
12	SCK	SPI clock input
13	MISO	SPI data output
14	MOSI	SPI data input
15	NSS	SPI chip select input
16	GND	Ground

The 3 general-purpose IO pins of SX1262 are available in LoRa™ mode. Their mapping relationship depends on the configuration of the two registers RegDioMapping1 and RegDioMapping2.

operating mode	DIOx Mapping	DIO 3	DIO2	DIO1
All	00	Cad Done	Fhss Change Channel	RxRime out
	01	Valid Header	Fhss Change Channel	Fhss Change Channel
	10	Payload Crc Error	Fhss Change Channel	CadDetected
	11	-	-	-

## 5. SCHEMATIC DIAGRAM

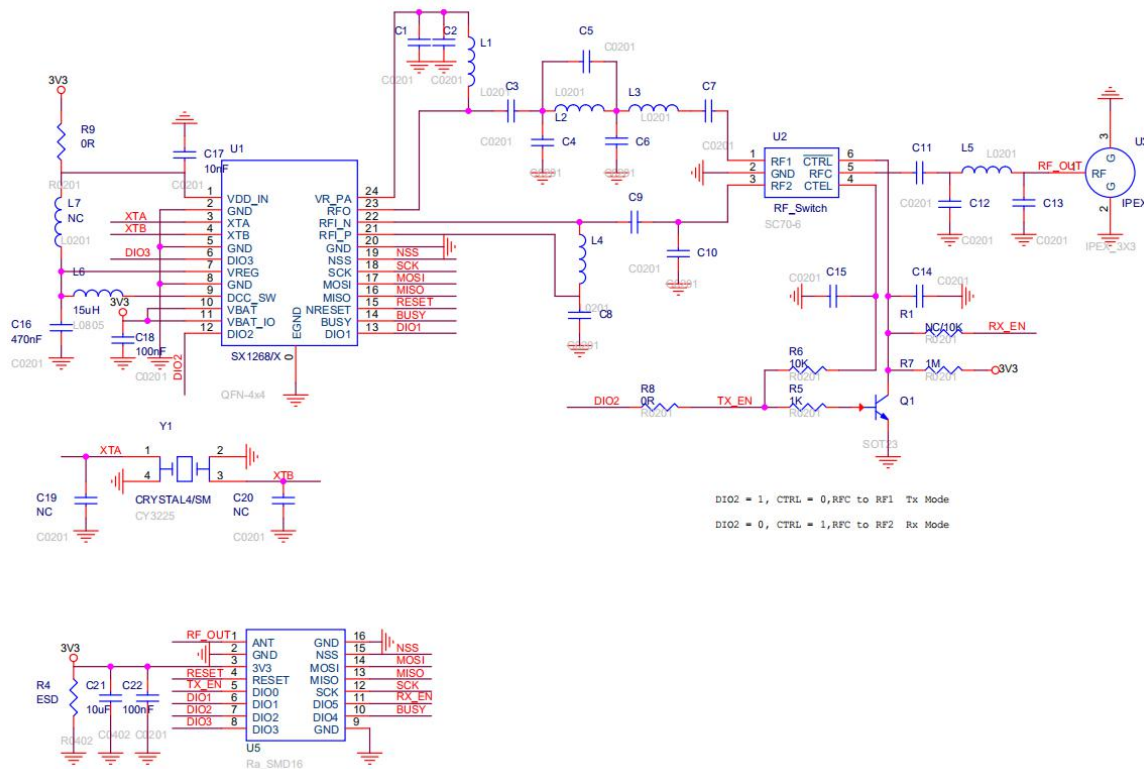

## 6. DESIGN GUIDE

### 1. Application circuit

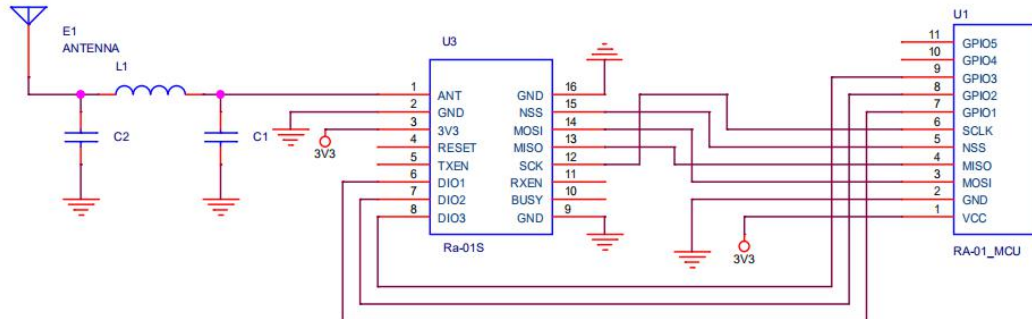

### 2. Recommended module package design size

Note: This is the Ra-01SH module package drawing. It is recommended to design the PCB board according to this drawing so that the module can work normally on the PCB board; and when designing the pads, pay attention to the design of the pads on the PCB. The group corresponding to the pad shrinks and offsets, and the PCB pad expands from the module pad without affecting the use of the module.

### 3. Antenna installation

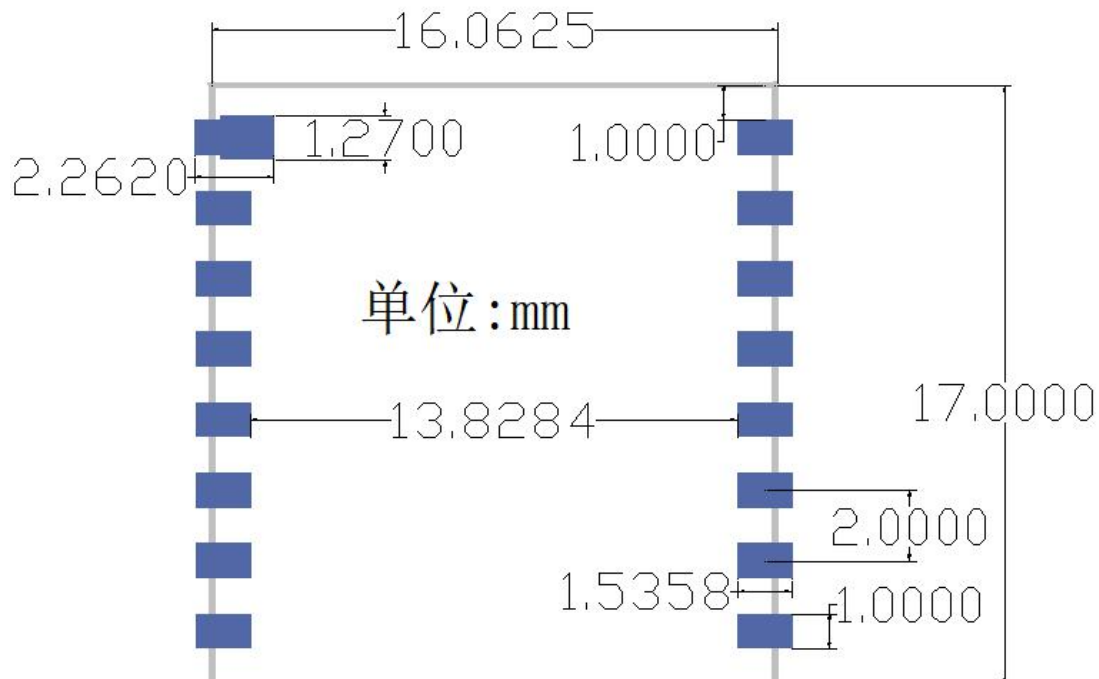



## 5、 Use of GPIO port

(1)、 There are some GPIO ports on the periphery of the module. If you need to use it, it is recommended to connect a 10-100 ohm resistor in series with the IO port. This can suppress overshoot and make the levels on both sides more stable. It is helpful for EMI and ESD.

(2)、 For the pull-up and pull-down of special IO ports, please refer to the instructions in the specification, which will affect the startup configuration of the module.

(3)、 The IO port of the module is 3.3V. If the main control and the IO level of the module do not match, a level conversion circuit needs to be added.

(4)、 If the IO port is directly connected to a peripheral interface or terminal such as a header, it is recommended to reserve an ESD device near the terminal of the IO trace.

Image Level conversion circuit

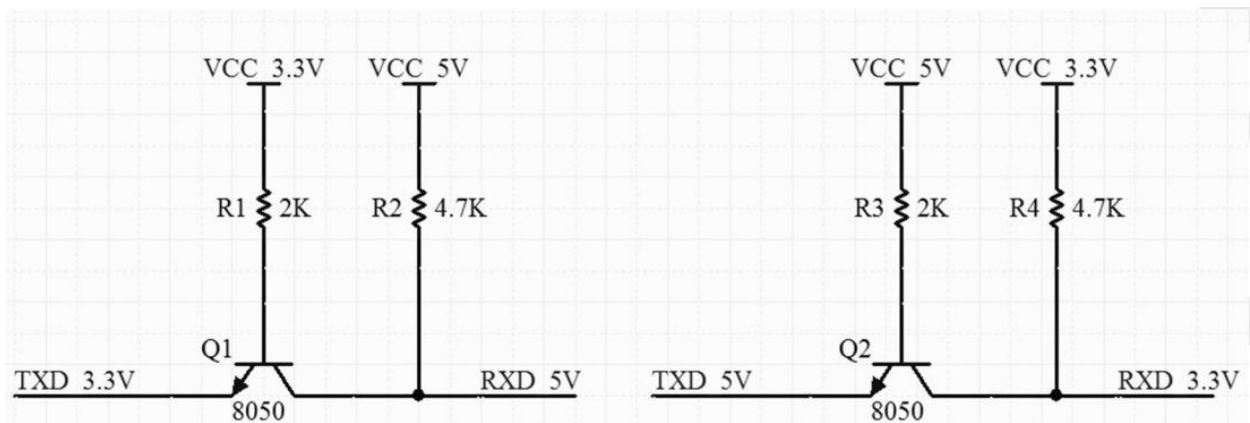

## 7. REFLOW SOLDERING CURVE

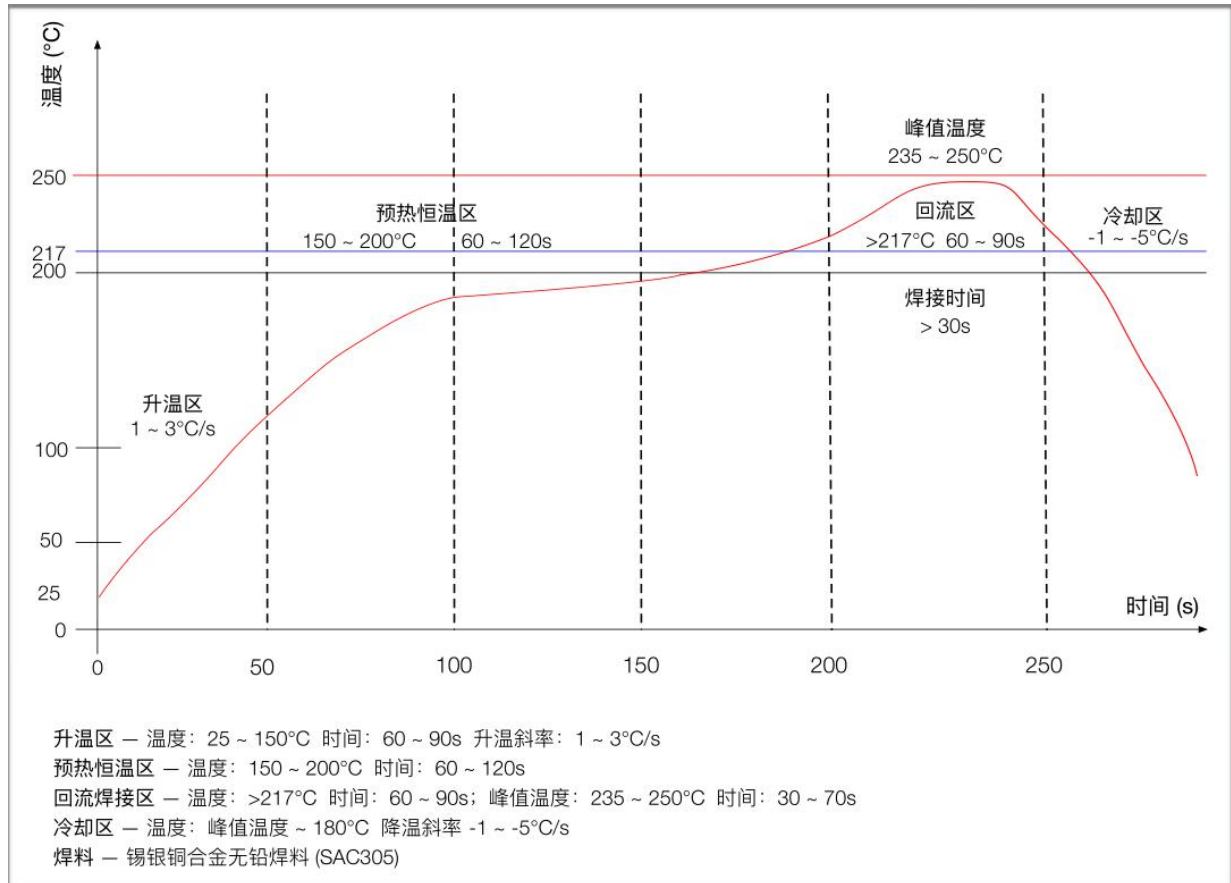

## 8.PACKAGE

As shown below, the packaging of Ra-01SH is braid.



## 9.CONTACT US

Website: <https://www.ai-thinker.com>

Development DOCS: <https://docs.ai-thinker.com>

Forun: <http://bbs.ai-thinker.com>

Sample purchase: <https://anxinke.taobao.com>

Business: [sales@aithinker.com](mailto:sales@aithinker.com)

Technical support: [support@aithinker.com](mailto:support@aithinker.com)

Address: 410, Block C, Huafeng Smart Innovation Port,

Gushu 2nd Road, Xixiang, Baoan District, Shenzhen



Tel: 0755-29162996

Copyright © 2020 Shenzhen Ai-Thinker Technology Co., Ltd All Rights Reserved









## Looking for pricing, stock, or lifecycle information?

Click below to explore more details on WIN SOURCE:

-  [View RA-01SH on WIN SOURCE](#)
-  [Ai-Thinker Information](#)

## Optimize Your Supply Chain with WIN SOURCE Solutions

-  Global Sourcing Solution
-  Obsolete Management
-  Cost Control Management
-  Shortage Management
-  Alternative Solution
-  Excess Inventory Management