



**THE DATASHEET OF
471KD05J**



DATA SHEET

METAL OXIDE VARISTORS POWER SUPPLY

05D series

RoHS compliant & Halogen free



Product specification— May 08, 2021 V.2



Metal Oxide Varistor (MOV) Data Sheet

Features

- Wide operating voltage (V_{1mA}) range from 18V to 750V
- Fast responding to transient over-voltage
- Large absorbing transient energy capability
- Low clamping ratio and no follow-on current
- Meets MSL level 1, per J-STD-020
- Operating Temperature: $-40^{\circ}\text{C} \sim +105^{\circ}\text{C}$
- Storage Temperature: $-40^{\circ}\text{C} \sim +125^{\circ}\text{C}$
- Safety certification: UL、CSA、VDE



Applications

- Transistor, diode, IC, thyristor or triac semiconductor protection
- Surge protection in consumer electronics
- Surge protection in industrial electronics
- Surge protection in electronic home appliances, gas and petroleum appliances
- Relay and electromagnetic valve surge absorption

Part Number Code

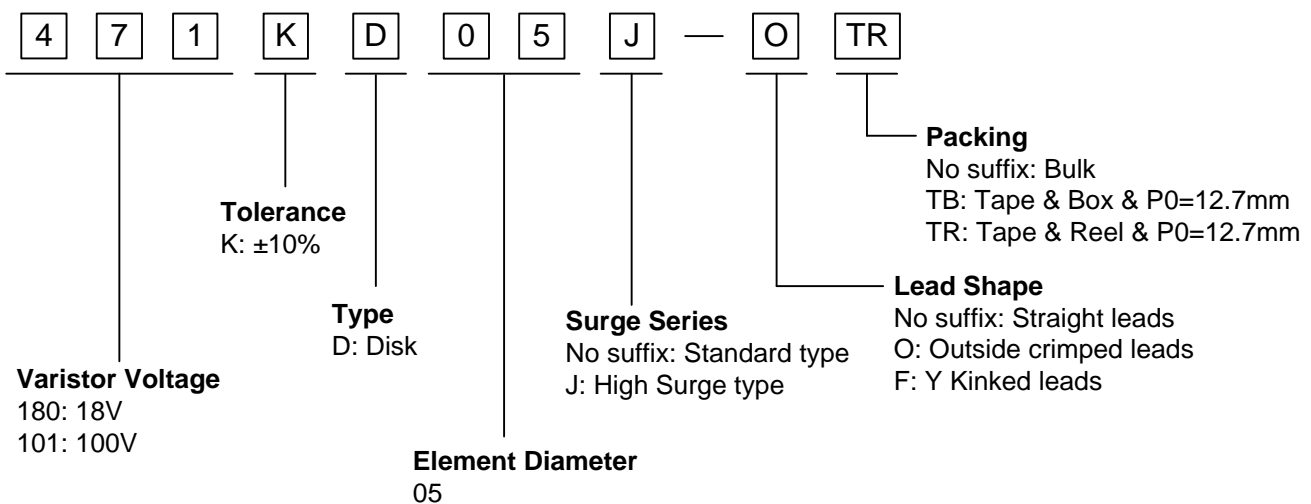

Dimensions

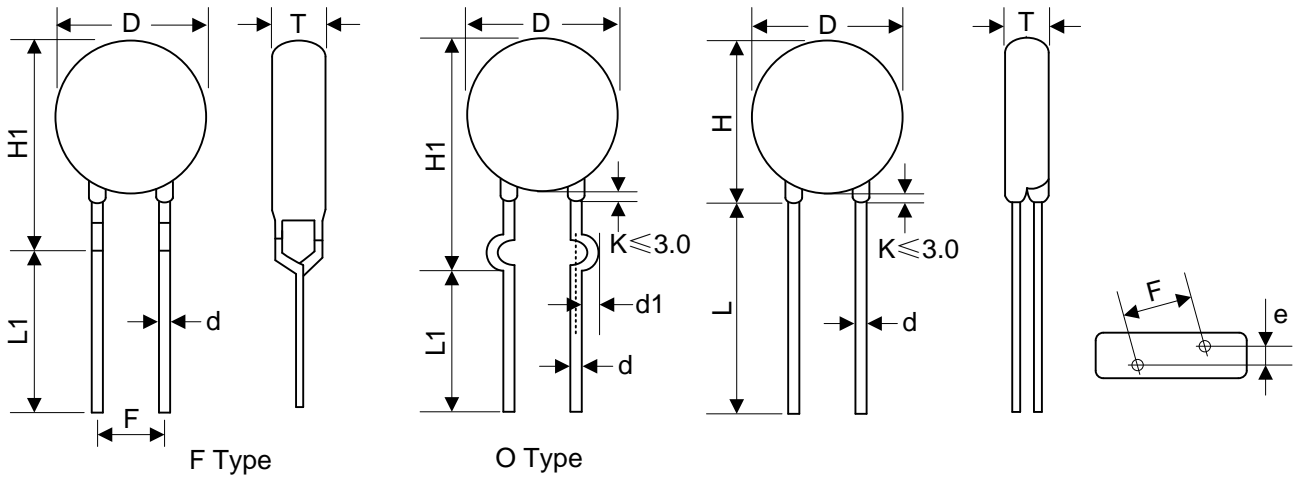

Table 1	
Unit: mm	
Symbol	Dimension
H	5.5~10.0
H1	8.0~13.0
L(min.)	20.0
L1(min.)	15.0
D	5.0~7.5
F(±0.8)	5.0
T	Table 2
e(±0.8)	Table 2
d(±0.05)	0.6
d1(±0.4)	1.2

Table 2					
Unit: mm					
Model	T	e	Model	T	e
180K	1.5~4.5	1.3	221K	2.0~4.5	1.9
220K	1.6~4.6	1.4	241K	2.1~4.6	2.0
270K	1.6~4.7	1.6	271K	2.1~4.9	2.2
330K	1.7~4.9	1.5	301K	2.2~5.0	2.3
390K	1.6~4.8	1.6	331K	2.2~5.1	2.3
470K	1.7~4.9	1.7	361K	2.4~5.2	2.5
560K	1.8~5.0	1.9	391K	2.5~5.4	2.6
680K	1.9~5.2	2.2	431K	2.7~5.7	2.8
820K	1.6~4.1	1.6	471K	2.8~6.0	3.0
101K	1.9~4.3	1.8	511K	2.9~6.2	3.2
121K	1.9~4.5	2.0	561K	3.1~6.5	3.4
151K	1.7~4.8	1.6	621K	3.3~6.5	3.7
181K	1.8~4.3	1.7	681K	3.5~6.8	4.0
201K	1.9~4.4	1.8	751K	3.8~6.9	4.1

Electrical Characteristics

Part Number		Maximum Allowable Voltage		Varistor Voltage	Maximum Clamping Voltage		Withstanding Surge Current		Maximum Energy (10/1000µs)		Rated Power	Typical Capacitance (Reference)
Standard	High Surge	V _{AC} (V)	V _{DC} (V)	V _{1mA} (V)	I _P (A)	V _C (V)	I (A) Standard	I (A) High Surge	(J) Standard	(J) High Surge	(W)	@1KHz (pf)
180KD05	180KD05J	11	14	18(15~21.6)	1	40	100	250	0.4	0.6	0.01	1400
220KD05	220KD05J	14	18	22(19.5~26)	1	48	100	250	0.5	0.7	0.01	1150
270KD05	270KD05J	17	22	27(24~31)	1	60	100	250	0.6	0.9	0.01	930
330KD05	330KD05J	20	26	33(29.5~36.5)	1	73	100	250	0.8	1.1	0.01	760
390KD05	390KD05J	25	31	39(35~43)	1	80	100	250	0.9	1.2	0.01	640
470KD05	470KD05J	30	38	47(42~52)	1	104	100	250	1.1	1.5	0.01	530
560KD05	560KD05J	35	45	56(50~62)	1	123	100	250	1.3	1.8	0.01	450
680KD05	680KD05J	40	56	68(61~75)	1	145	100	250	1.6	2.2	0.01	370
820KD05	820KD05J	50	65	82(74~90)	5	150	400	800	2.5	4.0	0.1	300
101KD05	101KD05J	60	85	100(90~110)	5	177	400	800	3.0	4.1	0.1	250
121KD05	121KD05J	75	100	120(108~132)	5	210	400	800	4.0	4.9	0.1	210
151KD05	151KD05J	95	125	150(135~165)	5	260	400	800	4.1	6.5	0.1	165
181KD05	181KD05J	115	150	180(162~198)	5	320	400	800	4.9	7.5	0.1	140
201KD05	201KD05J	130	170	200(180~220)	5	355	400	800	6.5	8.5	0.1	125
221KD05	221KD05J	140	180	220(198~242)	5	380	400	800	7.5	9.0	0.1	110
241KD05	241KD05J	150	200	240(216~264)	5	415	400	800	8.0	10.5	0.1	100
271KD05	271KD05J	175	225	270(243~297)	5	475	400	800	8.5	11.0	0.1	95
301KD05	301KD05J	190	250	300(270~330)	5	520	400	800	9.0	12.0	0.1	85
331KD05	331KD05J	210	275	330(297~363)	5	570	400	800	9.5	13.0	0.1	75
361KD05	361KD05J	230	300	360(324~396)	5	620	400	800	10.0	16.0	0.1	70
391KD05	391KD05J	250	320	390(351~429)	5	675	400	800	12.0	17.0	0.1	65
431KD05	431KD05J	275	350	430(387~473)	5	745	400	800	13.0	20.0	0.1	60
471KD05	471KD05J	300	385	470(423~517)	5	810	400	800	15.0	21.0	0.1	55
511KD05	511KD05J	320	415	510(459~561)	5	845	400	800	16.0	22.5	0.1	50
561KD05	561KD05J	350	460	560(504~616)	5	920	400	800	16.8	24.0	0.1	45
621KD05	621KD05J	385	505	620(558~682)	5	1025	400	800	17.7	25.0	0.1	40
681KD05	681KD05J	420	560	680(612~748)	5	1120	400	800	21.0	29.0	0.1	35
751KD05	751KD05J	460	615	750(675~825)	5	1240	400	800	22.4	32.0	0.1	30

Notes: 1. The tolerance of varistor voltage between 18V and 27V is more than 10%.

2. Leakage Current (@83% of V_{1mA}) : IR≤50µA (180K~680K) IR≤25µA (820K~751K)

Maximum Surge Current Derating Curve

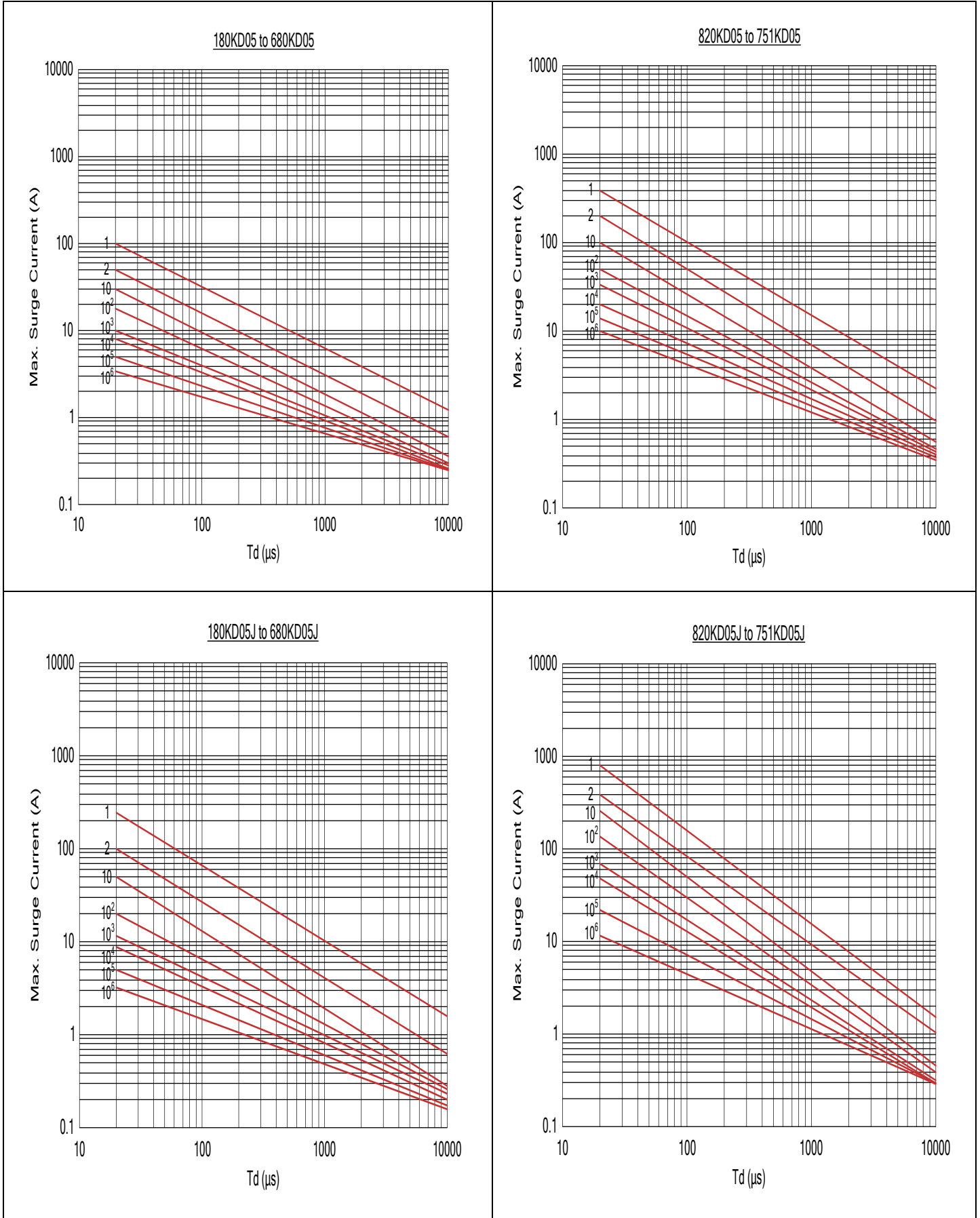

Maximum Leakage Current and Maximum Clamping Voltage Curve

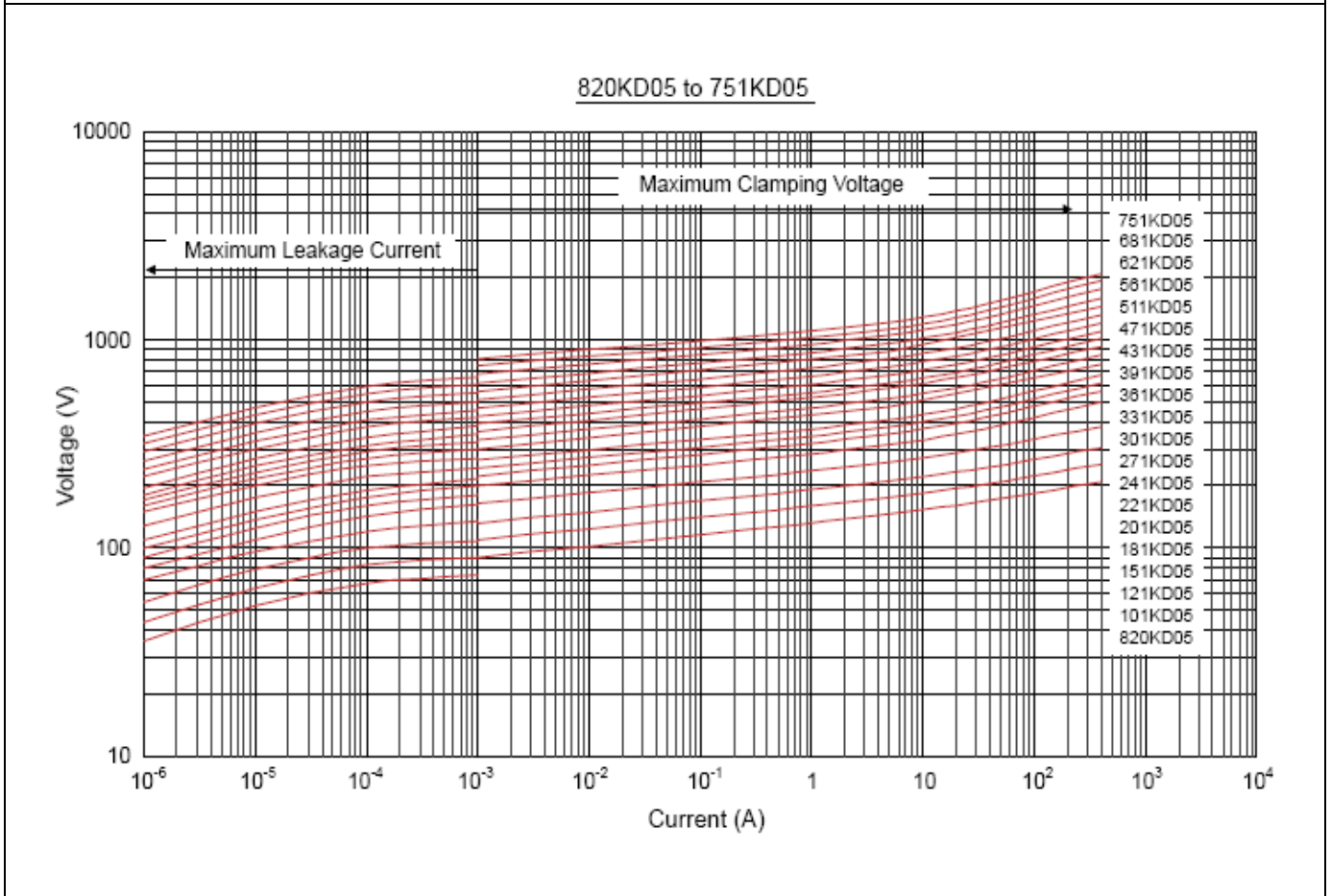
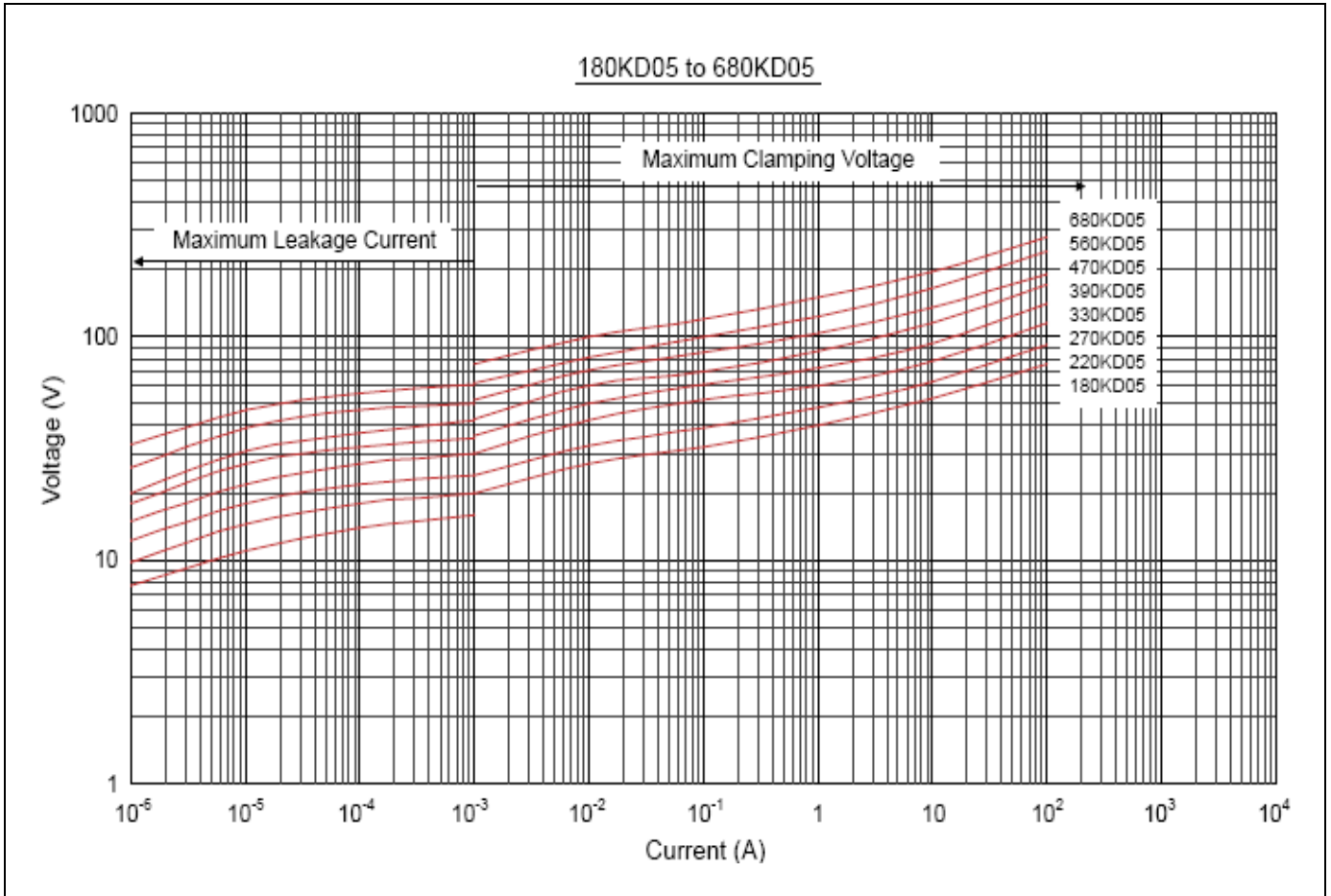

Maximum Leakage Current and Maximum Clamping Voltage Curve

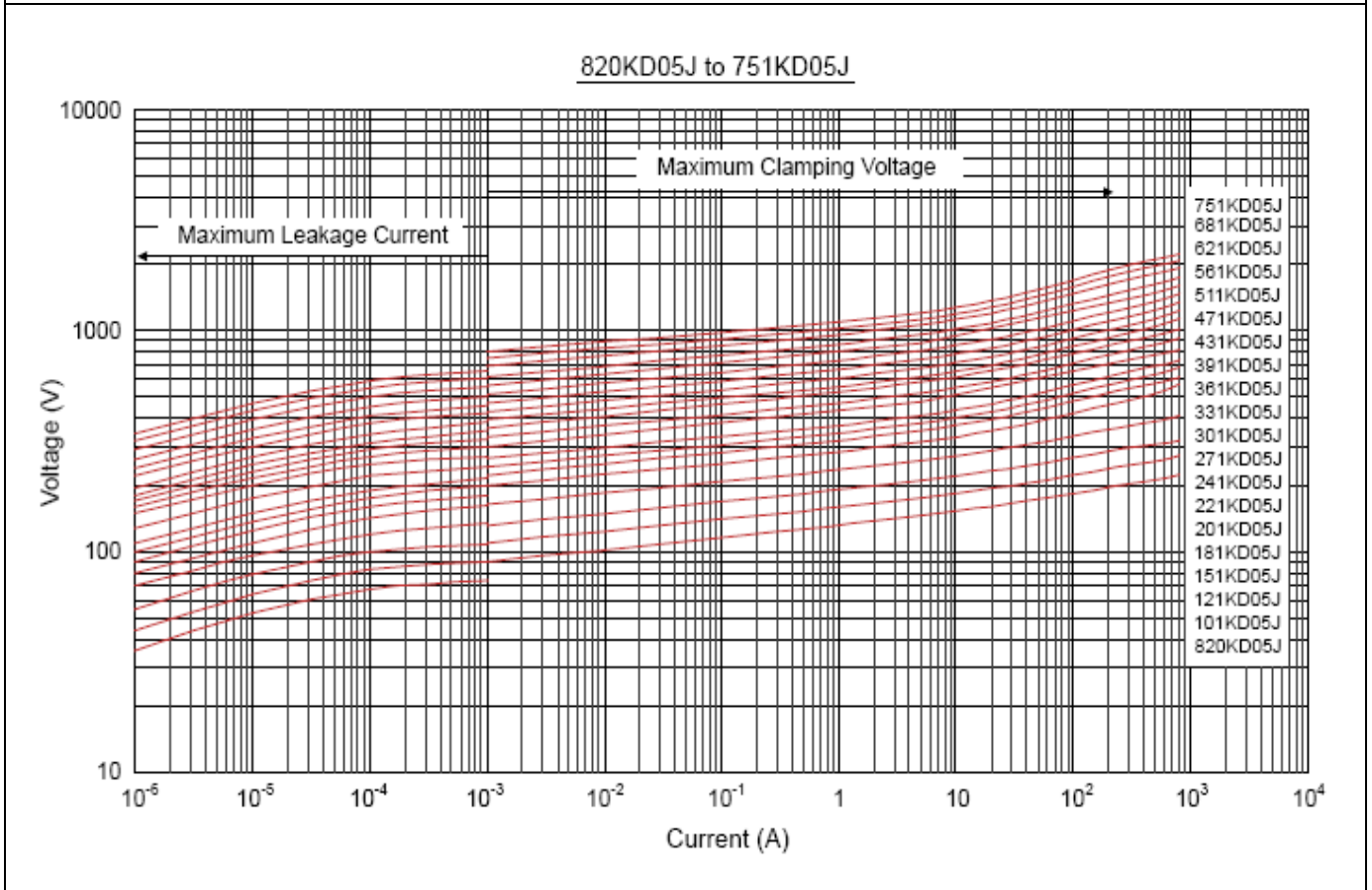
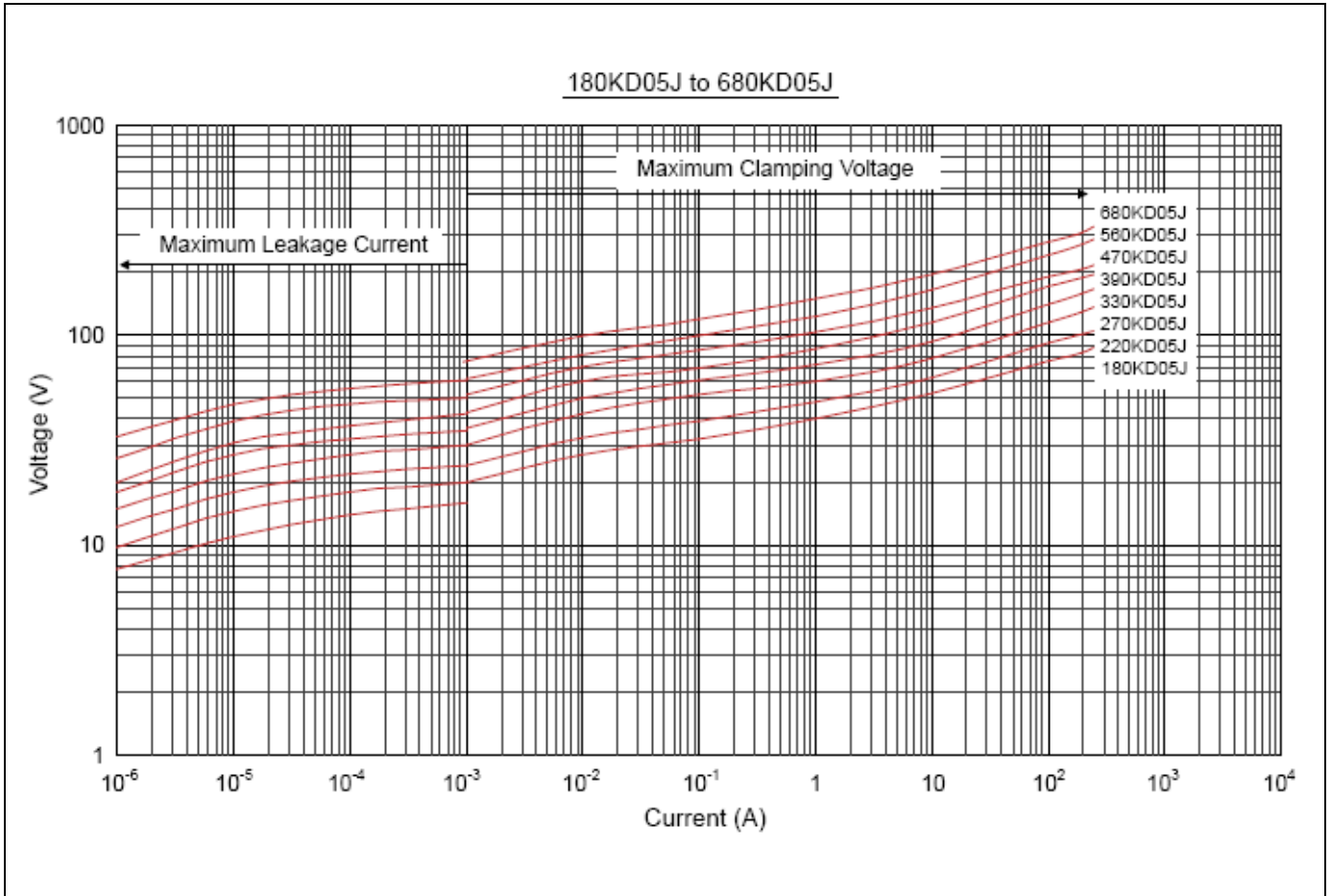

Reliability

Items	Standard	Test conditions / Methods	Specifications															
Tensile Strength of Terminals	IEC60068-2-21	Gradually applying the force specified and keeping the unit fixed for 10±1 sec. <table style="width: 100%; border-collapse: collapse;"> <tr> <td style="text-align: center; border-bottom: 1px solid black;">Terminal diameter (mm)</td> <td style="text-align: center; border-bottom: 1px solid black;">Force (kg)</td> </tr> <tr> <td style="text-align: center;">0.5 < d ≤ 0.8</td> <td style="text-align: center;">1.0</td> </tr> <tr> <td style="text-align: center;">0.8 < d ≤ 1.25</td> <td style="text-align: center;">2.0</td> </tr> <tr> <td style="text-align: center;">1.25 < d</td> <td style="text-align: center;">4.0</td> </tr> </table>	Terminal diameter (mm)	Force (kg)	0.5 < d ≤ 0.8	1.0	0.8 < d ≤ 1.25	2.0	1.25 < d	4.0	No visible damage ΔV _{1mA} /V _{1mA} ≤ 5%							
Terminal diameter (mm)	Force (kg)																	
0.5 < d ≤ 0.8	1.0																	
0.8 < d ≤ 1.25	2.0																	
1.25 < d	4.0																	
Bending Strength of Terminals	IEC60068-2-21	Hold specimen and apply the force specified below to each lead. Bend the specimen to 90°, then return to the original position. Repeat the procedure in the opposite direction. <table style="width: 100%; border-collapse: collapse;"> <tr> <td style="text-align: center; border-bottom: 1px solid black;">Terminal diameter (mm)</td> <td style="text-align: center; border-bottom: 1px solid black;">Force (kg)</td> </tr> <tr> <td style="text-align: center;">0.5 < d ≤ 0.8</td> <td style="text-align: center;">0.5</td> </tr> <tr> <td style="text-align: center;">0.8 < d ≤ 1.25</td> <td style="text-align: center;">1.0</td> </tr> <tr> <td style="text-align: center;">1.25 < d</td> <td style="text-align: center;">2.0</td> </tr> </table>	Terminal diameter (mm)	Force (kg)	0.5 < d ≤ 0.8	0.5	0.8 < d ≤ 1.25	1.0	1.25 < d	2.0	No visible damage ΔV _{1mA} /V _{1mA} ≤ 5%							
Terminal diameter (mm)	Force (kg)																	
0.5 < d ≤ 0.8	0.5																	
0.8 < d ≤ 1.25	1.0																	
1.25 < d	2.0																	
Vibration	IEC60068-2-6	Frequency range: 10~55 Hz Amplitude: 0.75mm or 98m/s ² Direction: 3 mutually perpendicular directions, 2hrs each.	No visible damage ΔV _{1mA} /V _{1mA} ≤ 5%															
Solderability	IEC60068-2-20	Solder Temp: 245±5°C Dipping Time: 2±0.5 sec	At least 95% of terminal electrode is covered by new solder															
Resistance to Soldering Heat	IEC60068-2-20	Solder Temp: 260±5°C Dipping Time: 10±1 sec	No visible damage ΔV _{1mA} /V _{1mA} ≤ 5%															
High Temperature Storage	IEC60068-2-2	Ambient Temp: 125±2°C Duration: 1000±24hrs	No visible damage ΔV _{1mA} /V _{1mA} ≤ 5%															
Low Temperature Storage	IEC60068-2-1	Ambient Temp: -40±2°C Duration: 1000±24hrs	No visible damage ΔV _{1mA} /V _{1mA} ≤ 5%															
Damp Heat, Steady State	IEC60068-2-78	The test is divided into two groups . a. 40±2°C , 90~95% RH for 1344±24hrs b. 40±2°C , 90~95% RH, at 10%VDC , 1344±24 hrs	No visible damage ΔV _{1mA} /V _{1mA} ≤ 10% Insulation Resistance ≥ 100MΩ															
High Temperature Load	MIL-STD-202 Method 108	Ambient Temp: 105±2°C Duration: 1000±24hrs Load: Max. Allowable Voltage In AC.	ΔV _{1mA} /V _{1mA} ≤ 10%															
Temperature Cycle	IEC60068-2-14	The conditions shown below shall be repeated 5 cycles <table border="1" style="width: 100%; border-collapse: collapse; margin-top: 10px;"> <thead> <tr> <th>Step</th> <th>Temperature (°C)</th> <th>Period (minutes)</th> </tr> </thead> <tbody> <tr> <td style="text-align: center;">1</td> <td style="text-align: center;">-40±3</td> <td style="text-align: center;">30±3</td> </tr> <tr> <td style="text-align: center;">2</td> <td style="text-align: center;">Room temperature</td> <td style="text-align: center;">5±3</td> </tr> <tr> <td style="text-align: center;">3</td> <td style="text-align: center;">125±3</td> <td style="text-align: center;">30±3</td> </tr> <tr> <td style="text-align: center;">4</td> <td style="text-align: center;">Room temperature</td> <td style="text-align: center;">5±3</td> </tr> </tbody> </table>	Step	Temperature (°C)	Period (minutes)	1	-40±3	30±3	2	Room temperature	5±3	3	125±3	30±3	4	Room temperature	5±3	No visible damage ΔV _{1mA} /V _{1mA} ≤ 5%
Step	Temperature (°C)	Period (minutes)																
1	-40±3	30±3																
2	Room temperature	5±3																
3	125±3	30±3																
4	Room temperature	5±3																
8/20uS Surge Life	IEC61051-1	8/20μS waveform, 10 surge currents, unipolar, interval 30secs, amplitude corresponding to max. surge current derating curves for 20μS.	No visible damage ΔV _{b(1mA)} ≤ ±10%															
10/1000μS Surge Life	IEC61051-1	10/1000μS waveform, 10 surge currents, unipolar, interval 2mins, amplitude corresponding to max. surge current derating curves for 1000μS.	No visible damage ΔV _{1mA} /V _{1mA} ≤ 10%															
Voltage Proof	IEC61051-1	Metal balls method, 2500Vac 1 min.	No visible damage															

Soldering Recommendation

Lead-free Wave Soldering Recommendation

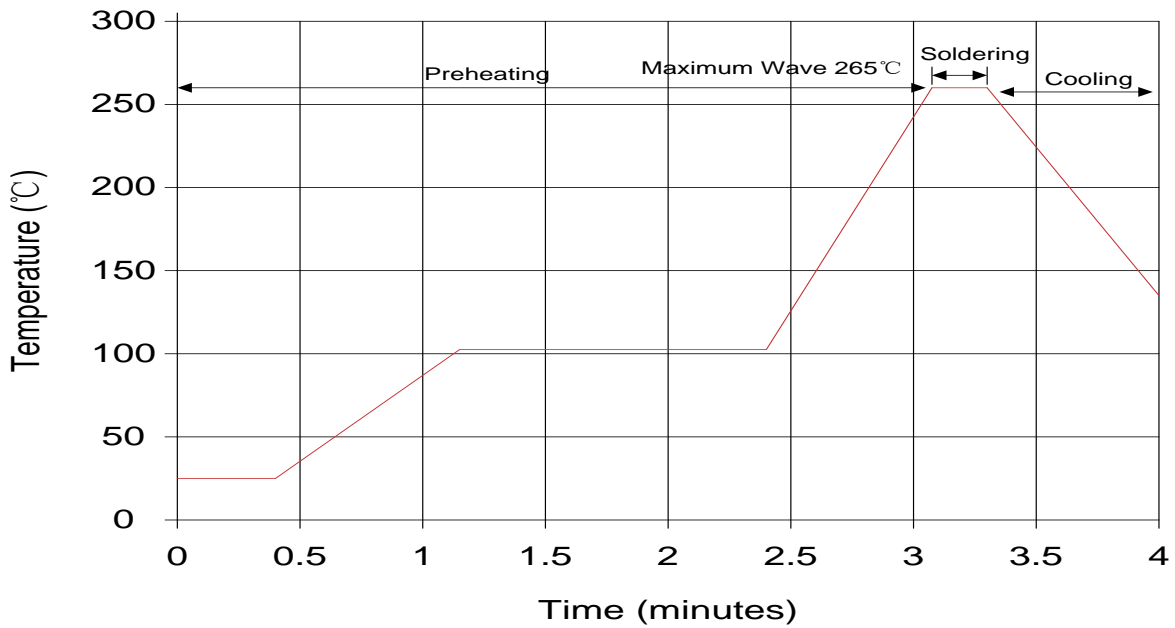

Item	Conditions
Peak Temperature	265°C
Dipping Time	10 seconds (max.)
Soldering	1 time

Recommendation Reworking Conditions with Soldering Iron

Item	Conditions
Temperature of Soldering Iron-tip	360°C (max.)
Soldering Time	3 seconds (max.)
Distance from Varistor	2mm (min.)

Marking Code

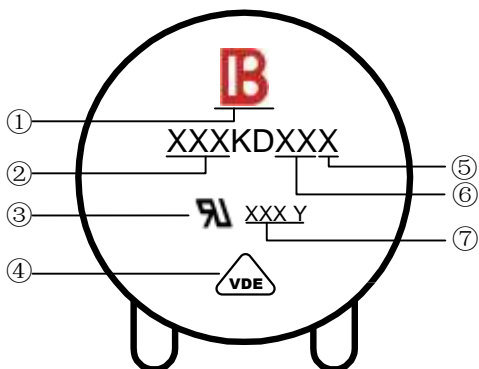

- ① Brightking Logo
- ② Varistor Voltage
- ③ UL Accreditation Logo
- ④ VDE Accreditation Logo
- ⑤ “J” is High Surge Code, no “J” is Standard Surge
- ⑥ Disk Size
- ⑦ Internal control code

Taping Dimensions

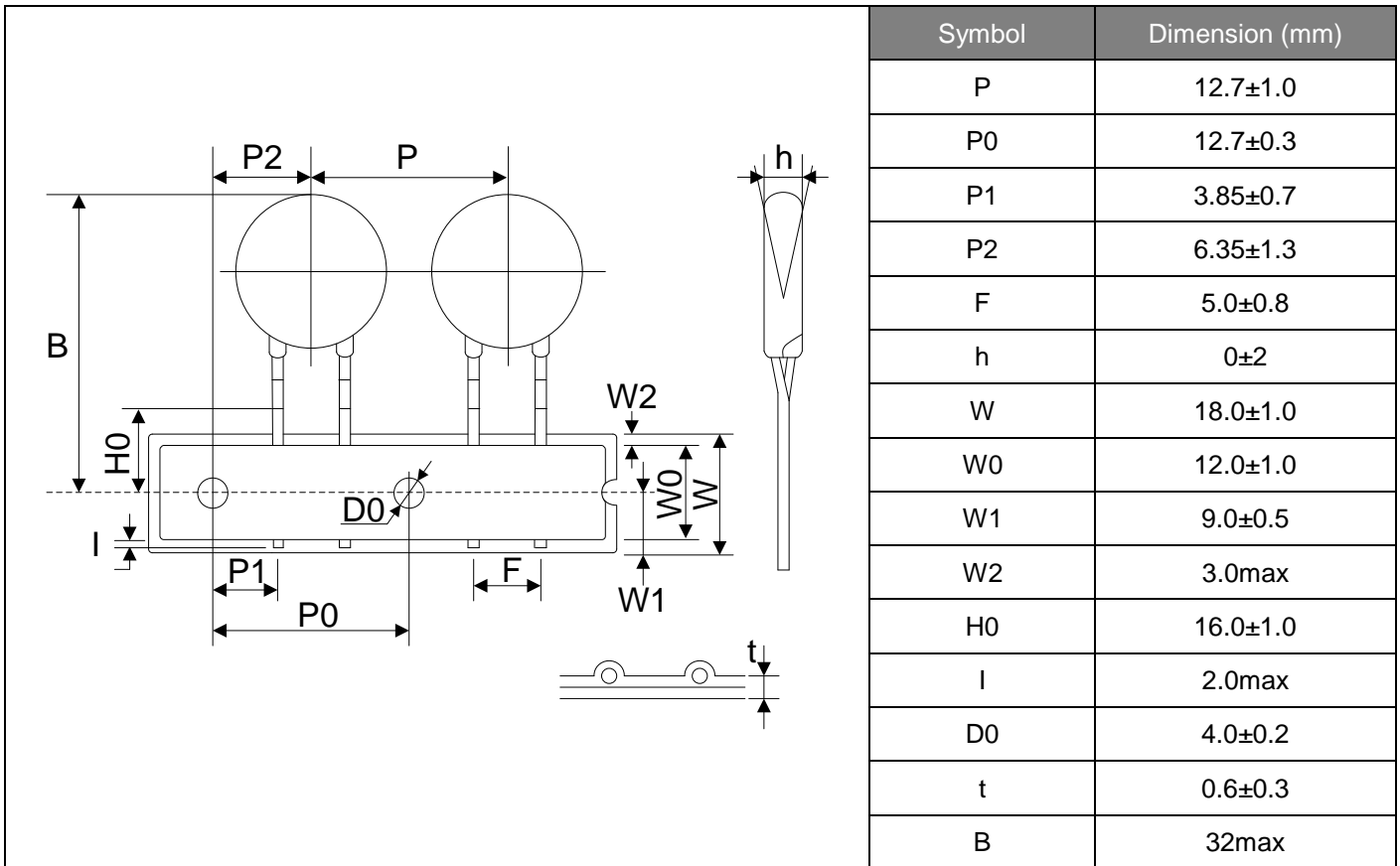
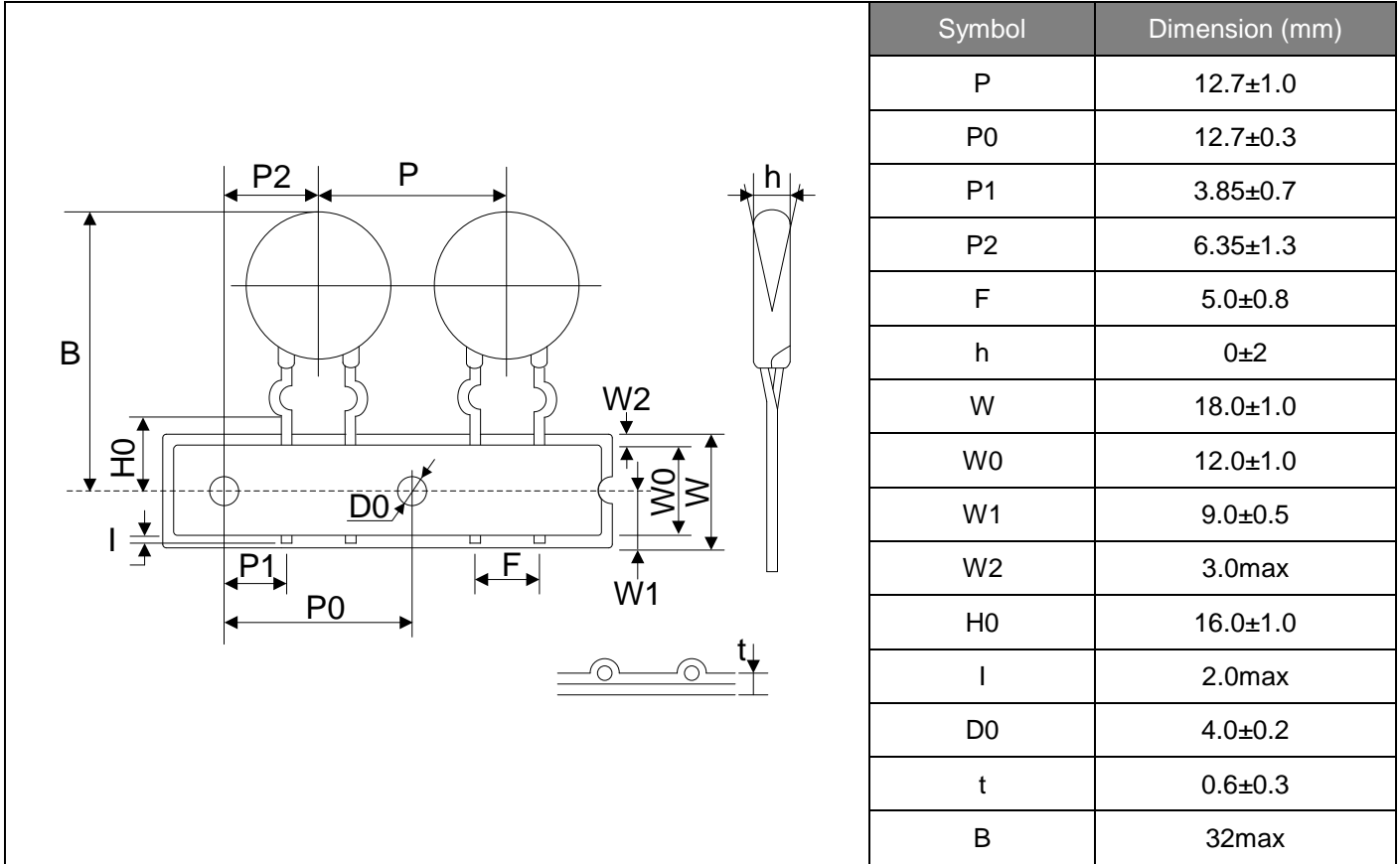

Taping Dimensions

Symbol	Dimension (mm)
P	12.7±1.0
P0	12.7±0.3
P1	3.85±0.7
P2	6.35±1.3
F	5.0±0.8
h	0±2
W	18.0±1.0
W0	12.0±1.0
W1	9.0±0.5
W2	3.0max
H2	20.0±2.0
l	2.0max
D0	4.0±0.2
t	0.6±0.3
B	32max

Quantity

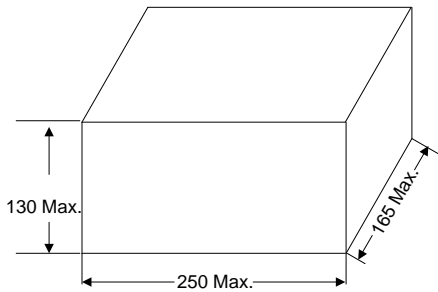
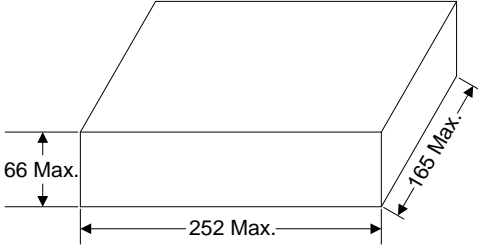
Packaging Dimensions (Unit: mm)	Quantity
<p>In bulk for Terminals Untrimmed Products</p> 	<p>1000pcs/bag 4bags/box (180K~751K)</p>
<p>In bulk for Terminals Trimmed Products</p> 	<p>1000pcs/bag 4bags/box (180K~751K)</p>

Quantity

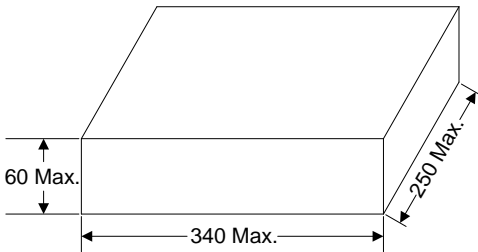
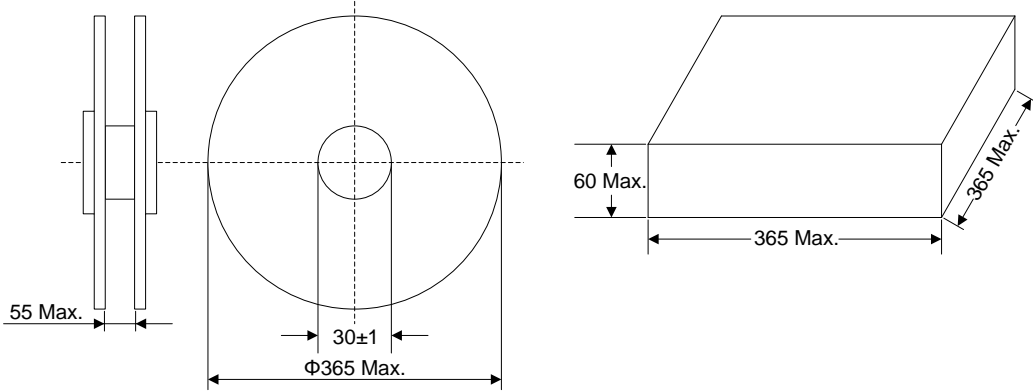
Packaging Dimensions (Unit: mm)	Quantity
<p>Tape & Box & P0=12.7mm</p> 	<p>1500pcs/box (180K~391K)</p>
	<p>1000pcs/box (431K~751K)</p>
<p>Tape & Reel & P0=12.7mm</p> 	<p>2000pcs/reel (180K~391K)</p>
	<p>1500pcs/reel (431K~751K)</p>

Storage Condition of Products

(I) Storage Conditions :

- 1.Storage Temperature : -10°C ~ +40°C
- 2.Relative Humidity : ≅ 80%RH
- 3.Keep away from corrosive atmosphere and sunlight.

(II) Period of Storage : 1 year

LEGAL DISCLAIMER

YAGEO, its distributors and agents (collectively, "YAGEO"), hereby disclaims any and all liabilities for any errors, inaccuracies or incompleteness contained in any product related information, including but not limited to product specifications, datasheets, pictures and/or graphics. YAGEO may make changes, modifications and/or improvements to product related information at any time and without notice.



YAGEO makes no representation, warranty, and/or guarantee about the fitness of its products for any particular purpose or the continuing production of any of its products. To the maximum extent permitted by law, YAGEO disclaims (i) any and all liability arising out of the application or use of any YAGEO product, (ii) any and all liability, including without limitation special, consequential or incidental damages, and (iii) any and all implied warranties, including warranties of fitness for a particular purpose, non-infringement and merchantability.

YAGEO products are designed for general purpose applications under normal operation and usage conditions. Please contact YAGEO for the applications listed below which require especially high reliability for the prevention of defects which might directly cause damage to the third party's life, body or property: Aerospace equipment (artificial satellite, rocket, etc.), Atomic energy-related equipment, Aviation equipment, Disaster prevention equipment, crime prevention equipment, Electric heating apparatus, burning equipment, Highly public information network equipment, data-processing equipment, Medical devices, Military equipment, Power generation control equipment, Safety equipment, Traffic signal equipment, Transportation equipment and Undersea equipment, or for any other application or use in which the failure of YAGEO products could result in personal injury or death, or serious property damage. Particularly **YAGEO Corporation and its affiliates do not recommend the use of commercial or automotive grade products for high reliability applications or manned space flight.**

Information provided here is intended to indicate product specifications only. YAGEO reserves all the rights for revising this content without further notification, as long as products are unchanged. Any product change will be announced by PCN.

Looking for pricing, stock, or lifecycle information?

Click below to explore more details on WIN SOURCE:

-  [View 471KD05J on WIN SOURCE](#)
-  [Yageo Information](#)

Optimize Your Supply Chain with WIN SOURCE Solutions

-  Global Sourcing Solution
-  Obsolete Management
-  Cost Control Management
-  Shortage Management
-  Alternative Solution
-  Excess Inventory Management