



**THE DATASHEET OF
UZR1V220MCL1GB**



ALUMINUM ELECTROLYTIC CAPACITORS

UZR

3.95mmLmax. Chip Type

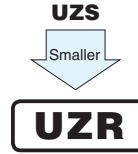

- Chip type with 3.95mmLmax height.
- Designed for surface mounting on high density PC board.
- Applicable to automatic mounting machine fed with carrier tape.
- Compliant to the RoHS directive (2011/65/EU,(EU)2015/863).
- AEC-Q200 compliant. Please contact us for details.

Products which are scheduled to be discontinued.
Not recommended for new designs.

Specifications

Item	Performance Characteristics																	
Category Temperature Range	-40 to +85°C																	
Rated Voltage Range	4 to 50V																	
Rated Capacitance Range	1 to 220μF																	
Capacitance Tolerance	±20% at 120Hz, 20°C																	
Leakage Current ※	After 2 minutes' application of rated voltage at 20°C, leakage current is not more than 0.01 CV or 3 (μA) , whichever is greater.																	
Tangent of loss angle (tan δ)	Rated voltage (V)	4	6.3	10	16	25	35	50	120Hz 20°C									
	tan δ (max.)	0.50	0.30	0.24	0.19	0.16	0.14	0.14										
Stability at Low Temperature	Rated voltage (V)	4	6.3	10	16	25	35	50	120Hz									
	Impedance ratio ZT / Z20 (max.)	Z(-25°C) / Z(+20°C)	7	4	3	2	2	2		2								
		Z(-40°C) / Z(+20°C)	15	8	8	4	4	3		3								
Endurance	The specifications listed at right shall be met when the capacitors are restored to 20°C after the rated voltage is applied for 1000 hours at 85°C.																	
										Capacitance change	Within ±30% of the initial capacitance value							
										tan δ	300% or less than the initial specified value							
Shelf Life	After storing the capacitors under no load at 85°C for 1000 hours and then performing voltage treatment based on JIS C 5101-4 clause 4.1 at 20°C, they shall meet the specified values for the endurance characteristics listed above.																	
										Capacitance change	Within ±10% of the initial capacitance value							
										Leakage current	Less than or equal to the initial specified value							
Resistance to soldering heat	The capacitors are kept on a hot plate for 30 seconds, which is maintained at 250°C. The capacitors shall meet the characteristic requirements listed at right when they are removed from the plate and restored to 20°C.																	
										Capacitance change	Within ±10% of the initial capacitance value							
										Leakage current	Less than or equal to the initial specified value							
Marking	Black print on the case top.																	

※ I : Leakage Current (μA), C : Rated Capacitance (μF), V : Rated Voltage (V)

Chip Type

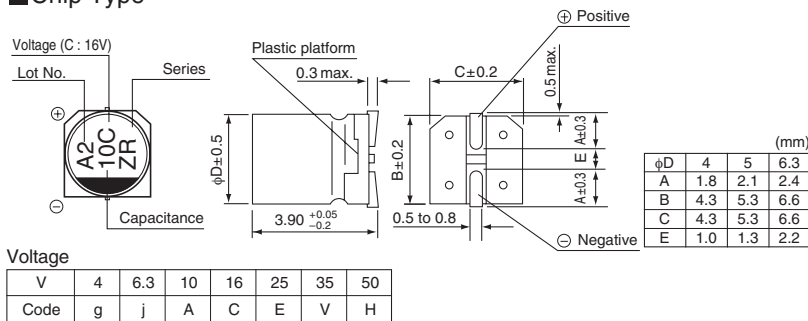

Type numbering system (Example : 16V 10μF)

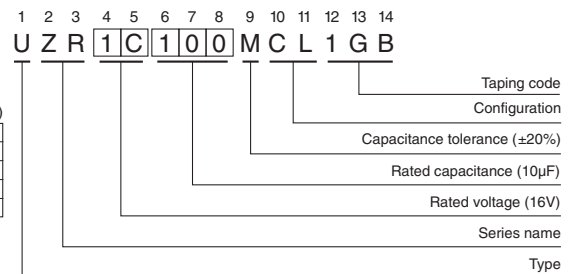

Frequency coefficient of rated ripple current

Frequency	50 Hz	120 Hz	300 Hz	1 kHz	10 kHz or more
Coefficient	0.70	1.00	1.17	1.36	1.50

● Dimension table in next page.

UZR

■ Dimensions

Rated Voltage (V) (code)	Rated Capacitance (μ F)	Case Size ϕ D \times L (mm)	$\tan \delta$	Leakage Current (μ A) (at 20°C after 2 minutes)	Rated Ripple (mArms) (85°C/120Hz)	Part Number
4 (0G)	33	4 \times 3.9	0.50	3	28	UZR0G330MCL1GB
	47	4 \times 3.9	0.50	3	33	UZR0G470MCL1GB
	100	5 \times 3.9	0.50	4	56	UZR0G101MCL1GB
	220	6.3 \times 3.9	0.50	8.8	96	UZR0G221MCL1GB
6.3 (0J)	22	4 \times 3.9	0.30	3	28	UZR0J220MCL1GB
	33	5 \times 3.9	0.30	3	37	UZR0J330MCL1GB
	47	5 \times 3.9	0.30	3	45	UZR0J470MCL1GB
	100	6.3 \times 3.9	0.30	6.3	70	UZR0J101MCL1GB
10 (1A)	22	5 \times 3.9	0.24	3	33	UZR1A220MCL1GB
	33	5 \times 3.9	0.24	3.3	41	UZR1A330MCL1GB
	47	6.3 \times 3.9	0.24	4.7	52	UZR1A470MCL1GB
16 (1C)	10	4 \times 3.9	0.19	3	23	UZR1C100MCL1GB
	22	5 \times 3.9	0.19	3.52	37	UZR1C220MCL1GB
	33	6.3 \times 3.9	0.19	5.28	49	UZR1C330MCL1GB
	47	6.3 \times 3.9	0.19	7.52	58	UZR1C470MCL1GB
25 (1E)	4.7	4 \times 3.9	0.16	3	16	UZR1E4R7MCL1GB
	10	5 \times 3.9	0.16	3	27	UZR1E100MCL1GB
	22	6.3 \times 3.9	0.16	5.5	42	UZR1E220MCL1GB
	33	6.3 \times 3.9	0.16	8.25	52	UZR1E330MCL1GB
35 (1V)	4.7	4 \times 3.9	0.14	3	18	UZR1V4R7MCL1GB
	10	5 \times 3.9	0.14	3.5	29	UZR1V100MCL1GB
	22	6.3 \times 3.9	0.14	7.7	46	UZR1V220MCL1GB
50 (1H)	1	4 \times 3.9	0.14	3	8.4	UZR1H010MCL1GB
	2.2	4 \times 3.9	0.14	3	13	UZR1H2R2MCL1GB
	3.3	4 \times 3.9	0.14	3	17	UZR1H3R3MCL1GB
	4.7	5 \times 3.9	0.14	3	20	UZR1H4R7MCL1GB
	10	6.3 \times 3.9	0.14	5	33	UZR1H100MCL1GB

• For taping specifications, recommended land size/soldering by reflow and minimum order quantity, please refer to the Guidelines for Aluminum Electrolytic Capacitors.







Looking for pricing, stock, or lifecycle information?

Click below to explore more details on WIN SOURCE:

 [View UZR1V220MCL1GB on WIN SOURCE](#)

 [Nichicon](#) Information

Optimize Your Supply Chain with WIN SOURCE Solutions

-  Global Sourcing Solution
-  Obsolete Management
-  Cost Control Management
-  Shortage Management
-  Alternative Solution
-  Excess Inventory Management